

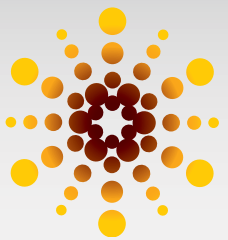

# STOCKED TOWERS CATALOGUE CANADA 2019

TITAN® SS SuperTITAN® KD SuperTITAN® MAX STG™



# Trylon

[www.trylon.com](http://www.trylon.com)

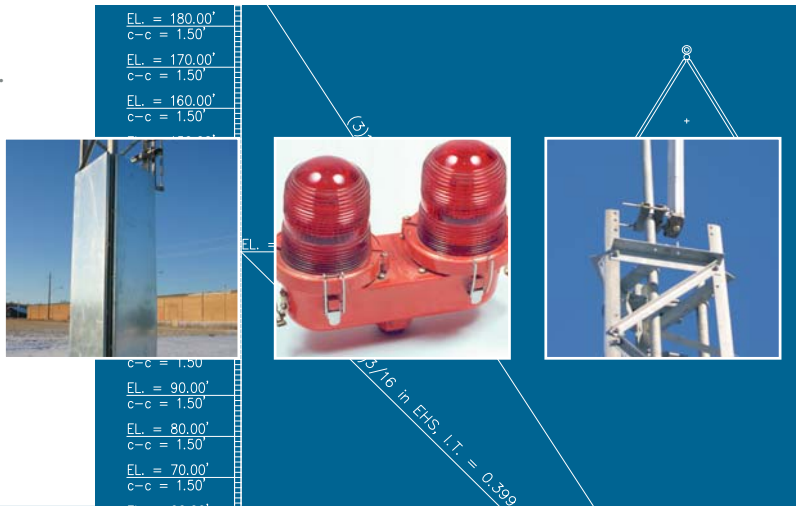

# Table of Contents

## Titan® Self-Support Towers..... 1

Tower Comparison.....	2
16' Titan SS Towers.....	3
24' Titan SS Towers.....	4
32' Titan SS Towers.....	5
40' Titan SS Towers.....	6
48' Titan SS Towers.....	7
56' Titan SS Towers.....	8
64' Titan SS Towers.....	9
72' Titan SS Towers.....	10
80' Titan SS Towers.....	11
88' Titan SS Towers.....	12
96' Titan SS Towers.....	13
Individual Tower Sections.....	14
Accessories.....	15
Replacement Parts.....	22
Concrete Foundation Details.....	25

## SuperTitan® Self-Support Towers.....27

Wind Load Capacity for CSA Class 1 vs Class 3.....	28
20' Towers.....	29
30' Towers.....	30
40' Towers.....	31
50' Towers.....	32
60' Towers.....	34
70' Towers.....	36
80' Towers.....	38
90' Towers.....	40
100' Towers.....	42
110' Towers.....	44
120' Towers.....	46
130' Towers.....	48
140' Towers.....	50
150' Towers.....	52
160' Towers.....	54
170' Towers.....	55
180' Towers.....	56
190' Towers.....	57
Individual Tower Sections.....	58
Accessories.....	61
Replacement Parts.....	73
Anti-Climb Panel Installation.....	77
Concrete Foundation Details.....	78

## SuperTitan® Max Towers .....81

Tower Comparison.....	82
Tower Profile.....	83
99' Towers.....	84
108' Towers.....	85
118' Towers.....	86
127' Towers.....	87
137' Towers.....	88
146' Towers.....	89
156' Towers.....	90
165' Towers.....	91
175' Towers.....	92
184' Towers.....	93
194' Towers.....	94
203' Towers.....	95
213' Towers.....	96
222' Towers.....	97
232' Towers.....	98
241' Towers.....	99
251' Towers.....	100
Accessories.....	101

## SuperTitan® Weld Towers ..... 103

20' Towers.....	105
30' Towers.....	106
40' Towers.....	107
50' Towers.....	108
60' Towers.....	110
70' Towers.....	112
80' Towers.....	114
90' Towers.....	116
100' Towers.....	118
110' Towers.....	120
120' Towers.....	122
130' Towers.....	124
40' Towers.....	125
150' Towers.....	126

## STG™ Tower Series ..... 129

STG vs Rohn Guyed.....	130
Tower Sections.....	131
STG Self-Support Complete Towers/ Foundation Details.....	132
STG Bracketed Complete Towers/ Foundation Details.....	133
STG Guyed Complete Towers/ Foundation Details.....	134
Concrete Foundation Details.....	139
Accessories.....	140
P.Eng Stamped Drawings.....	146

## Notes

- Any tower loading capacities stated in this Stocked Towers Catalogue are based upon a maximum allowable antenna area being centrally located and balanced no more than 0.2m above the tower top. Addition of offset distances or other variations may result in a reduction of allowable antenna areas.
- Allowable antenna areas (sq.m.) stated in this book for SuperTITAN SS towers are based on one (1) 0.02m coax line per 0.93 sq.m. of round member antenna area placed at the tower top. If user has antenna placements below the tower top, or at wind speeds that do not correspond to the wind speeds in this book, they should contact Trylon TSF® or a Trylon TSF® Distributor to request a FREE TowerCalc™ analysis to determine the appropriate tower for the application.
- Readers are cautioned to understand the difference between wind load capacity based on "EIA 222-F", BS8100, and "Survival" standards. Some towers in this book provide maximum wind load ratings for both types. Prior to making any tower purchase, the user should first determine if their tower requirement calls for a "Survival", "EIA 222", or BS8100 1986 rating.
- In reference to wind load capacities, "--" means the tower model failed at that wind speed.

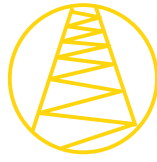

# TITAN<sup>®</sup>TOWER

SELF-SUPPORT

- .. Free-standing TITAN<sup>™</sup> Self-Support Towers need only minimal footprint area
- .. Heights ranging from 24 ft. (7.3 m) to 96 ft. (28.8 m)
- .. Lightweight, commercial-duty
- .. Ideal for ISP and SCADA
- .. Survives up to 100mph, depending on height and model

Titan, the introductory level to the Stocked Tower family!

Total Height: 96'  
Total Load: 15 sq ft\*



(\*70 mph Survival Wind Speed & 0" ice)

Total Height: 190'  
Total Load: 10 sq ft\*

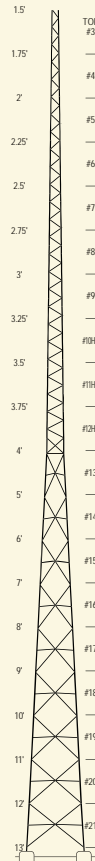

(\*350 Pa CSA S37-01 & 25 mm ice)

**MAX Height: 251'**  
**MAX Load: 92 sq ft\***

EL. = 251.00'  
h-h = 2.50'

EL. = 241.00'  
h-h = 2.76'

EL. = 222.00'  
h-h = 3.25'

EL. = 203.00'  
h-h = 3.75'

EL. = 190.00'  
h-h = 4.00'

EL. = 171.00'  
h-h = 6.00'

EL. = 152.00'  
h-h = 8.00'

EL. = 133.00'  
h-h = 10.00'

EL. = 114.00'  
h-h = 12.00'

EL. = 95.00'  
h-h = 14.00'

EL. = 76.00'  
h-h = 16.00'

EL. = 57.00'  
h-h = 18.00'

EL. = 38.00'  
h-h = 20.00'

EL. = 19.00'  
h-h = 22.00'

EL. = 0'  
h-h = 24.00'

(\*350 Pa CSA S37-01 & 25 mm ice)



- Survival tower
- Not compliant to CSA 537-13
- Stocked and sold through distribution
- Ship assembled in 8' sections
- Max face width: 45 inches
- P.Eng. stamp **not** available
- Model shown: 96' T200

- CSA S37-13 compliant
- Stocked and sold through distribution
- Ship knocked-down (unassembled) in 10' sections
- Max face width: 13 feet
- P.Eng. stamp available
- Model shown: 190' S310

- CSA S37-13 compliant
- Ships directly from Trylon
- Ship knocked-down (unassembled) in 19' sections
- Max face width: 24 feet
- P.Eng. stamp available
- Model shown: 251' M300

# 16' Towers

Model Designation:		T200	T300	T400	T500	T600	T700	T800
Part Number:		4.95.0201.000	4.95.0301.000	4.95.0401.000	4.95.0501.000	4.95.0601.000	4.95.0701.000	4.95.0801.000
Includes 4' anchor stub legs for concrete, splice hardware, 8' antenna mounting pipe, angle frames, and u-bolt assembly in top section.								
Allowable antenna area in ft <sup>2</sup> at 70/85/100 mph wind*	Survival 1/2" ice	Round: 2/-- Flat: 1/--	Round: 3/-- Flat: 2/--	Round: 10/-- Flat: 6/--	Round: 24/1-- Flat: 16/1--	Round: 36/6-- Flat: 24/4--	Round: 60/18/2 Flat: 45/12/1	Round: 80/32/6 Flat: 53/21/4
	Shipping Dimensions (L"xW"xH")	101x40x17	101x40x20	101x40x22	101x40x26	101x40x32	101x50x36	101x60x38
Shipping Weight (lbs)		189	210	233	264	294	320	363

\*Based on the antenna load being centrally located and balanced 3' or less above the tower top ("--" indicates tower failure). Titan Towers are based on survival design and cannot be P.Eng. Stamped.

## Common Accessories

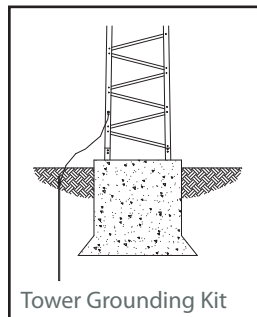

Accessory:	T200	T300	T400	T500	T600	T700	T800
<b>Safety Rail System</b> trolley sold separately	4.97.0510.216	4.97.0510.316	4.97.0510.416	4.97.0510.516	4.97.0510.616	4.97.0510.716	4.97.0510.816
<b>Anti-Climb Shield</b> set of 3	N/A	4.92.0104.000	4.92.0105.000	4.92.0106.000	4.92.0107.000	4.92.0108.000	4.92.0109.000
<b>Tower Grounding Kit</b> with #6 copper wire	4.91.0101.000	4.91.0101.000	4.91.0101.000	4.91.0101.000	4.91.0101.000	4.91.0101.000	4.91.0101.000
<b>Side Mount (Top Section)</b> with 2 angle frames, clip angles, u-bolt assemblies, and 6' pipe	4.84.1141.000	4.84.1142.000	4.84.1151.000	4.84.1152.000	4.84.1161.000	4.84.1162.000	4.84.1171.000
For more Antenna Side Mount Kits, see accessories page 16.							
<b>Base Foot Weldments</b> set of 3	4.82.0104.000	4.82.0105.000	4.82.0106.000	4.82.0107.000	4.82.0108.000	4.82.0109.000	4.82.0110.000
<b>Rock Bolts</b> with nuts & flat washers 3-pak	4.80.0100.100	4.80.0100.100	4.80.0100.100	4.80.0100.100	4.80.0100.100	4.80.0100.100	4.80.0102.100
<b>Lighting Kits</b> with cable	4.93.0102.000	4.93.0102.000	4.93.0102.000	4.93.0102.000	4.93.0102.000	4.93.0102.000	4.93.0102.000

For more TITAN Accessories and Replacement Parts, see pages 15 to 24.

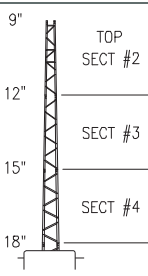
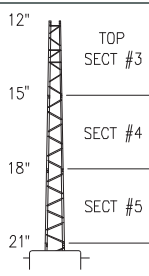
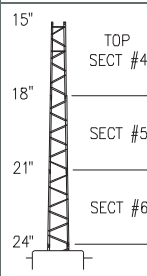
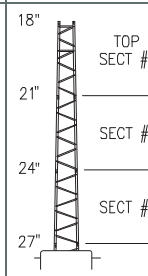
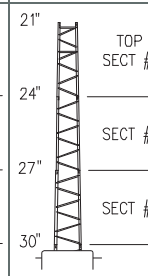
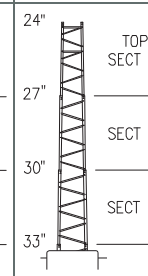
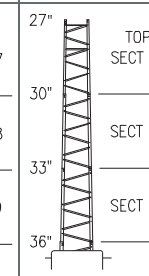
Model Designation:		T200	T300	T400	T500	T600	T700	T800
Part Number:		4.95.0202.000	4.95.0302.000	4.95.0402.000	4.95.0502.000	4.95.0602.000	4.95.0702.000	4.95.0802.000
Includes 4' anchor stub legs for concrete, splice hardware, 8' antenna mounting pipe, angle frames, and u-bolt assembly in top section.								
Allowable antenna area in ft <sup>2</sup> at 70/85/100 mph wind*	Survival 1/2" ice	Round: 2/--/-- Flat: 1/--/--	Round: 3/--/-- Flat: 2/--/--	Round: 10/--/-- Flat: 6/--/--	Round: 24/1/-- Flat: 16/1/--	Round: 36/6/-- Flat: 24/4/--	Round: 60/18/2 Flat: 45/12/1	Round: 80/32/6 Flat: 53/21/4
Shipping Dimensions (L"xW"xH")		101x40x20	101x40x22	101x40x26	101x48x32	101x50x36	101x60x38	101x60x40
Shipping Weight (lbs)		234	259	302	340	379	433	516

\*Based on the antenna load being centrally located and balanced 3' or less above the tower top ("--" indicates tower failure). Titan Towers are based on survival design and cannot be PEng. Stamped.

## Common Accessories

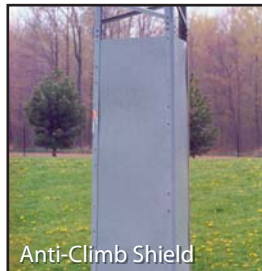

Accessory:	T200	T300	T400	T500	T600	T700	T800
<b>Safety Rail System</b> trolley sold separately	4.97.0510.224	4.97.0510.324	4.97.0510.424	4.97.0510.524	4.97.0510.624	4.97.0510.724	4.97.0510.824
<b>Anti-Climb Shield</b> set of 3	4.92.0104.000	4.92.0105.000	4.92.0106.000	4.92.0107.000	4.92.0108.000	4.92.0109.000	4.92.0110.000
<b>Tower Grounding Kit</b> with #6 copper wire	4.91.0101.000	4.91.0101.000	4.91.0101.000	4.91.0101.000	4.91.0101.000	4.91.0101.000	4.91.0101.000
<b>Side Mount (Top Section)</b> with 2 angle frames, clip angles, u-bolt assemblies, and 6' pipe	4.84.1141.000	4.84.1142.000	4.84.1151.000	4.84.1152.000	4.84.1161.000	4.84.1162.000	4.84.1171.000
For more Antenna Side Mount Kits, see accessories page 16.							
<b>Base Foot Weldments</b> set of 3	4.82.0105.000	4.82.0106.000	4.82.0107.000	4.82.0108.000	4.82.0109.000	4.82.0110.000	4.82.0111.000
<b>Rock Bolts</b> with nuts & flat washers 3-pak	4.80.0100.100	4.80.0100.100	4.80.0100.100	4.80.0100.100	4.80.0100.100	4.80.0102.100	4.80.0102.100
<b>Lighting Kits</b> with cable	4.93.0103.000	4.93.0103.000	4.93.0103.000	4.93.0103.000	4.93.0103.000	4.93.0103.000	4.93.0103.000

For more TITAN Accessories and Replacement Parts, see pages 15 to 24.

# 32' Towers



Model Designation:		T200	T300	T400	T500	T600	T700	T800
Part Number:		4.95.0203.000	4.95.0303.000	4.95.0403.000	4.95.0503.000	4.95.0603.000	4.95.0703.000	4.95.0803.000
Includes 4' anchor stub legs for concrete, splice hardware, 8' x 1.9"OD antenna mounting pipe.  Tower height shown is nominal. Actual tower height is achieved using support pipe provided with tower.								
Allowable antenna area in ft <sup>2</sup> at 70/85/100 mph wind*	Survival 1/2" ice	Round: 2/--/-- Flat: 1/--/--	Round: 3/--/-- Flat: 2/--/--	Round: 10/--/-- Flat: 6/--/--	Round: 24/1/-- Flat: 16/1/--	Round: 36/6/-- Flat: 24/4/--	Round: 60/18/2 Flat: 45/12/1	Round: 80/32/6 Flat: 53/21/4
Shipping Dimensions (L"xW"xH")		101x40x22	101x40x26	101x48x32	101x50x36	101x60x38	101x60x40	101x64x42
Shipping Weight (lbs)		283	328	377	425	493	587	675

\*Based on the antenna load being centrally located and balanced 3' or less above the tower top ("--" indicates tower failure). Titan Towers are based on survival design and cannot be P.Eng. Stamped.

## Common Accessories

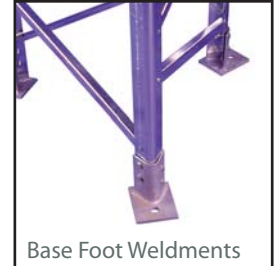

Accessory:	T200	T300	T400	T500	T600	T700	T800
<b>Safety Rail System</b> trolley sold separately	4.97.0510.232	4.97.0510.332	4.97.0510.432	4.97.0510.532	4.97.0510.632	4.97.0510.732	4.97.0510.832
<b>Anti-Climb Shield</b> set of 3	4.92.0105.000	4.92.0106.000	4.92.0107.000	4.92.0108.000	4.92.0109.000	4.92.0110.000	4.92.0111.000
<b>Tower Grounding Kit</b> with #6 copper wire	4.91.0101.000	4.91.0101.000	4.91.0101.000	4.91.0101.000	4.91.0101.000	4.91.0101.000	4.91.0101.000
<b>Side Mount (Top Section)</b> with 2 angle frames, clip angles, u-bolt assemblies, and 6' pipe	4.84.1141.000	4.84.1142.000	4.84.1151.000	4.84.1152.000	4.84.1161.000	4.84.1162.000	4.84.1171.000
For more Antenna Side Mount Kits, see accessories page 16.							
<b>Base Foot Weldments</b> set of 3	4.82.0106.000	4.82.0107.000	4.82.0108.000	4.82.0109.000	4.82.0110.000	4.82.0111.000	4.82.0112.000
<b>Rock Bolts</b> with nuts & flat washers 3-pak	4.80.0100.100	4.80.0100.100	4.80.0100.100	4.80.0100.100	4.80.0102.100	4.80.0102.100	4.80.0102.100

For more TITAN Accessories and Replacement Parts, see pages 15 to 24.



Model Designation:		T200	T300	T400	T500	T600	T700	T800
Part Number:		4.95.0204.000	4.95.0304.000	4.95.0404.000	4.95.0504.000	4.95.0604.000	4.95.0704.000	4.95.0804.000
Includes 4' anchor stub legs for concrete, splice hardware, 8' x 1.9"OD antenna mounting pipe.  Tower height shown is nominal. Actual tower height is achieved using support pipe provided with tower.								
Allowable antenna area in ft <sup>2</sup> at 70/85/100 mph wind*	Survival 1/2" ice	Round: 2/--/-- Flat: 1/--/--	Round: 3/--/-- Flat: 2/--/--	Round: 10/--/-- Flat: 6/--/--	Round: 24/1/-- Flat: 16/1/--	Round: 36/6/-- Flat: 24/4/--	Round: 60/18/2 Flat: 45/12/1	Round: 80/32/6 Flat: 53/21/4
Shipping Dimensions (L"xW"xH")		101x40x26	101x48x32	101x50x36	101x60x38	101x60x40	101x64x42	101x67x45
Shipping Weight (lbs)		352	403	463	538	647	743	833

\*Based on the antenna load being centrally located and balanced 3' or less above the tower top ("--" indicates tower failure). Titan Towers are based on survival design and cannot be PEEng. Stamped.

## Common Accessories

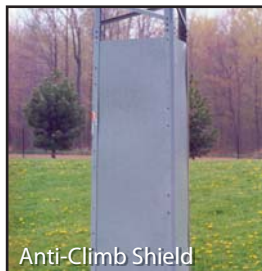

Accessory:	T200	T300	T400	T500	T600	T700	T800
<b>Safety Rail System</b> trolley sold separately	4.97.0510.240	4.97.0510.340	4.97.0510.440	4.97.0510.540	4.97.0510.640	4.97.0510.740	4.97.0510.840
<b>Anti-Climb Shield</b> set of 3	4.92.0106.000	4.92.0107.000	4.92.0108.000	4.92.0109.000	4.92.0110.000	4.92.0111.000	4.92.0112.000
<b>Tower Grounding Kit</b> with #6 copper wire	4.91.0101.000	4.91.0101.000	4.91.0101.000	4.91.0101.000	4.91.0101.000	4.91.0101.000	4.91.0101.000
<b>Side Mount (Top Section)</b> with 2 angle frames, clip angles, u-bolt assemblies, and 6' pipe	4.84.1141.000	4.84.1142.000	4.84.1151.000	4.84.1152.000	4.84.1161.000	4.84.1162.000	4.84.1171.000
For more Antenna Side Mount Kits, see accessories page 16.							
<b>Base Foot Weldments</b> set of 3	4.82.0107.000	4.82.0108.000	4.82.0109.000	4.82.0110.000	4.82.0111.000	4.82.0112.000	4.82.0113.000

For more TITAN Accessories and Replacement Parts, see pages 15 to 24.

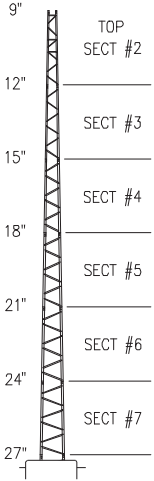
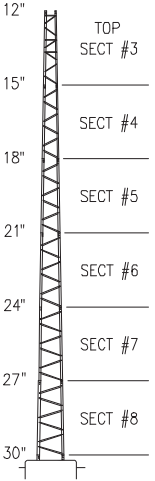
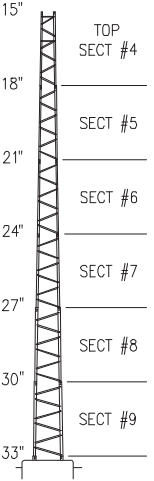
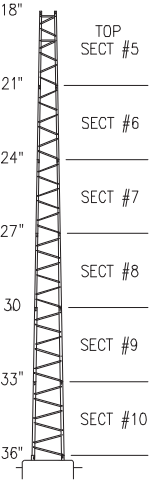
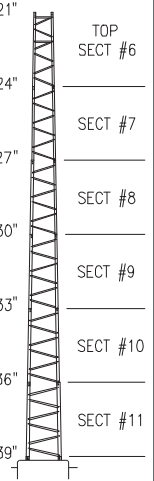
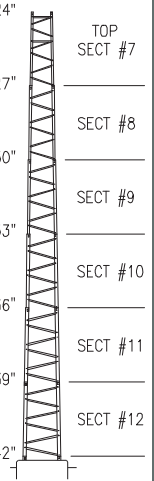
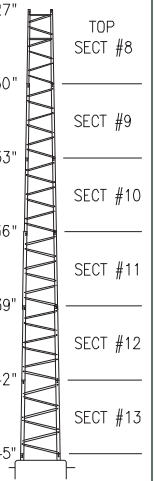

Model Designation:	T200	T300	T400	T500	T600	T700	T800	
Part Number:	4.95.0205.000	4.95.0305.000	4.95.0405.000	4.95.0505.000	4.95.0605.000	4.95.0705.000	4.95.0805.000	
Includes 4' anchor stub legs for concrete, splice hardware, 8' x 1.9"OD antenna mounting pipe.  Tower height shown is nominal. Actual tower height is achieved using support pipe provided with tower.								
Allowable antenna area in ft <sup>2</sup> at 70/85/100 mph wind*	Survival 1/2" ice	Round: 2/--/-- Flat: 1/--/--	Round: 3/--/-- Flat: 2/--/--	Round: 10/--/-- Flat: 6/--/--	Round: 24/1/-- Flat: 16/1/--	Round: 36/6/-- Flat: 24/4/--	Round: 60/18/2 Flat: 45/12/1	Round: 80/32/6 Flat: 53/21/4
Shipping Dimensions (L"xW"xH")	101x48x32	101x50x36	101x60x38	101x60x40	101x64x42	101x67x45	101x75x49	
Shipping Weight (lbs)	427	489	577	692	803	904	1,044	

\*Based on the antenna load being centrally located and balanced 3' or less above the tower top ("--" indicates tower failure). Titan Towers are based on survival design and cannot be P.Eng. Stamped.

## Common Accessories

Accessory:	T200	T300	T400	T500	T600	T700	T800
<b>Safety Rail System</b> trolley sold separately	4.97.0510.248	4.97.0510.348	4.97.0510.448	4.97.0510.548	4.97.0510.648	4.97.0510.748	4.97.0510.848
<b>Anti-Climb Shield</b> set of 3	4.92.0107.000	4.92.0108.000	4.92.0109.000	4.92.0110.000	4.92.0111.000	4.92.0112.000	4.92.0113.000
<b>Tower Grounding Kit</b> with #6 copper wire	4.91.0101.000	4.91.0101.000	4.91.0101.000	4.91.0101.000	4.91.0101.000	4.91.0101.000	4.91.0101.000
<b>Side Mount (Top Section)</b> with 2 angle frames, clip angles, u-bolt assemblies, and 6' pipe	4.84.1141.000	4.84.1142.000	4.84.1151.000	4.84.1152.000	4.84.1161.000	4.84.1162.000	4.84.1171.000
For more Antenna Side Mount Kits, see accessories page 16.							
<b>Base Foot Weldments</b> set of 3	4.82.0108.000	4.82.0109.000	4.82.0110.000	4.82.0111.000	4.82.0112.000	4.82.0113.000	4.82.0114.000
<b>Rock Bolts</b> with nuts & flat washers 3-pak	4.80.0100.100	4.80.0100.100	4.80.0100.100	4.80.0102.100	4.80.0102.100	4.80.0102.100	4.80.0102.200
<b>Lighting Kits</b> with cable	4.93.0106.000	4.93.0106.000	4.93.0106.000	4.93.0106.000	4.93.0106.000	4.93.0106.000	4.93.0106.000

For more TITAN Accessories and Replacement Parts, see pages 15 to 24.

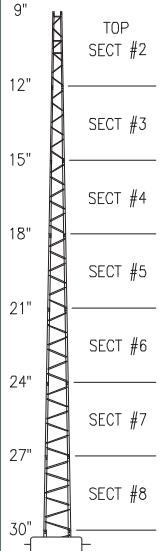
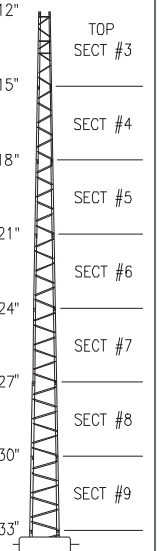
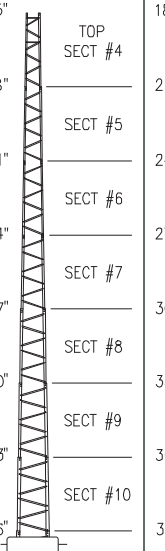
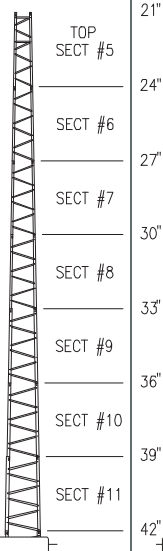
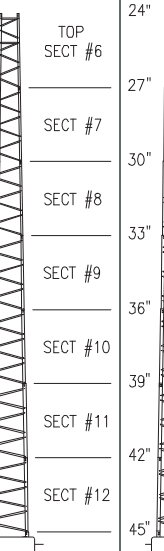
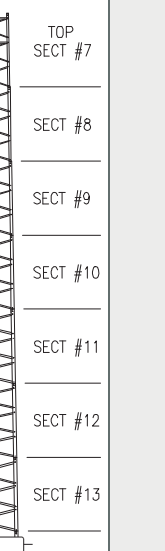
Model Designation:		T200	T300	T400	T500	T600	T700
Part Number:		4.95.0206.000	4.95.0306.000	4.95.0406.000	4.95.0506.000	4.95.0606.000	4.95.0706.000
Includes 4' anchor stub legs for concrete, splice hardware, 8' x 1.9"OD antenna mounting pipe.  Tower height shown is nominal. Actual tower height is achieved using support pipe provided with tower.							
Allowable antenna area in ft <sup>2</sup> at 70/85/100 mph wind*	Survival 1/2" ice	Round: 2/--/-- Flat: 1/--/--	Round: 3/--/-- Flat: 2/--/--	Round: 10/--/-- Flat: 6/--/--	Round: 24/1/-- Flat: 16/1/--	Round: 36/6/-- Flat: 24/4/--	Round: 60/18/2 Flat: 45/12/1
Shipping Dimensions (L"xW"xH")		101x50x36	101x60x38	101x60x40	101x64x42	101x67x45	101x75x49
Shipping Weight (lbs)		513	602	730	848	964	1,115

\*Based on the antenna load being centrally located and balanced 3' or less above the tower top ("--" indicates tower failure). Titan Towers are based on survival design and cannot be P.Eng. Stamped.

## Common Accessories

Accessory:	T200	T300	T400	T500	T600	T700
<b>Safety Rail System</b> trolley sold separately	4.97.0510.256	4.97.0510.356	4.97.0510.456	4.97.0510.556	4.97.0510.656	4.97.0510.756
<b>Anti-Climb Shield</b> set of 3	4.92.0108.000	4.92.0109.000	4.92.0110.000	4.92.0111.000	4.92.0112.000	4.92.0113.000
<b>Tower Grounding Kit</b> with #6 copper wire	4.91.0101.000	4.91.0101.000	4.91.0101.000	4.91.0101.000	4.91.0101.000	4.91.0101.000
<b>Side Mount (Top Section)</b> with 2 angle frames, clip angles, u-bolt assemblies, and 6' pipe	4.84.1141.000	4.84.1142.000	4.84.1151.000	4.84.1152.000	4.84.1161.000	4.84.1162.000
For more Antenna Side Mount Kits, see accessories page 16.						
<b>Base Foot Weldments</b> set of 3	4.82.0109.000	4.82.0110.000	4.82.0111.000	4.82.0112.000	4.82.0113.000	4.82.0114.000
<b>Rock Bolts</b> with nuts & flat washers 3-pak	4.80.0100.100	4.80.0100.100	4.80.0102.100	4.80.0102.100	4.80.0102.100	4.80.0102.200
<b>Lighting Kits</b> with cable	4.93.0107.000	4.93.0107.000	4.93.0107.000	4.93.0107.000	4.93.0107.000	4.93.0107.000

For more TITAN Accessories and Replacement Parts, see pages 15 to 24.

Model Designation:		T200	T300	T400	T500	T600		
Part Number:		4.95.0207.000	4.95.0307.000	4.95.0407.000	4.95.0507.000	4.95.0607.000		
<p>Includes 4' anchor stub legs for concrete, splice hardware, 8' x 1.9"OD antenna mounting pipe.</p> <p>To support the mounting pipe, every top section is factory installed with angle frames and u-bolts at top and middle of the section.</p> <p>Tower height shown is nominal. Actual tower height is achieved using support pipe provided with tower.</p>								
Allowable antenna area in ft <sup>2</sup> at 70/85/100 mph wind*	Survival 1/2" ice	Round: 2/--/-- Flat: 1/--/--	Round: 3/--/-- Flat: 2/--/--	Round: 10/--/-- Flat: 6/--/--	Round: 24/1/-- Flat: 16/1/--	Round: 36/6/-- Flat: 24/4/--		
Shipping Dimensions (L"xW"xH")		101x60x38	101x60x40	101x64x42	101x67x45	101x75x49		
Shipping Weight (lbs)		627	756	886	1,009	1,174		

\*Based on the antenna load being centrally located and balanced 3' or less above the tower top ("--" indicates tower failure). Titan Towers are based on survival design and cannot be P.Eng. Stamped.

## Common Accessories

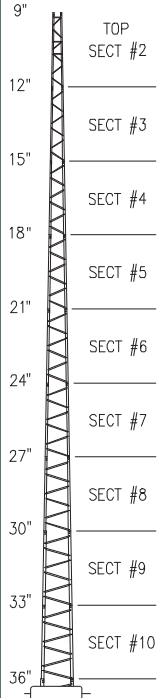
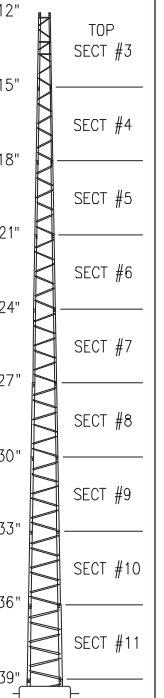
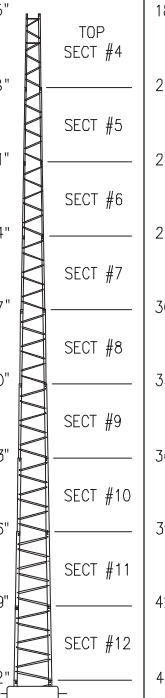
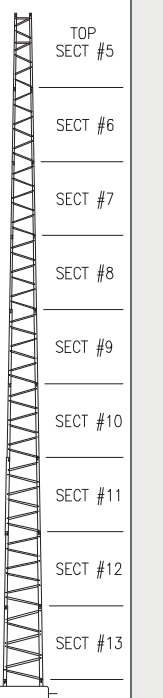

Accessory:	T200	T300	T400	T500	T600		
<b>Safety Rail System</b> trolley sold separately	4.97.0510.264	4.97.0510.364	4.97.0510.464	4.97.0510.564	4.97.0510.664		
<b>Anti-Climb Shield</b> set of 3	4.92.0109.000	4.92.0110.000	4.92.0111.000	4.92.0112.000	4.92.0113.000		
<b>Tower Grounding Kit</b> with #6 copper wire	4.91.0101.000	4.91.0101.000	4.91.0101.000	4.91.0101.000	4.91.0101.000		
<b>Side Mount (Top Section)</b> with 2 angle frames, clip angles, u-bolt assemblies, and 6' pipe	4.84.1141.000	4.84.1142.000	4.84.1151.000	4.84.1152.000	4.84.1161.000		
For more Antenna Side Mount Kits, see accessories page 16.							
<b>Base Foot Weldments</b> set of 3	4.82.0110.000	4.82.0111.000	4.82.0112.000	4.82.0113.000	4.82.0114.000		
<b>Rock Bolts</b> with nuts & flat washers 3-pak	4.80.0100.100	4.80.0102.100	4.80.0102.100	4.80.0102.100	4.80.0102.200		

For more TITAN Accessories and Replacement Parts, see pages 15 to 24.

Model Designation:		T200	T300	T400	T500			
Part Number:		4.95.0208.000	4.95.0308.000	4.95.0408.000	4.95.0508.000			
<p>Includes 4' anchor stub legs for concrete, splice hardware, 8' x 1.9"OD antenna mounting pipe.</p> <p>To support the mounting pipe, every top section is factory installed with angle frames and u-bolts at top and middle of the section.</p> <p>Tower height shown is nominal. Actual tower height is achieved using support pipe provided with tower.</p>		 <p>9" TOP SECT #2 12" SECT #3 15" SECT #4 18" SECT #5 21" SECT #6 24" SECT #7 27" SECT #8 30" SECT #9 33" SECT #10 36"</p>	 <p>12" TOP SECT #3 15" SECT #4 18" SECT #5 21" SECT #6 24" SECT #7 27" SECT #8 30" SECT #9 33" SECT #10 36" SECT #11 39"</p>	 <p>15" TOP SECT #4 18" SECT #5 21" SECT #6 24" SECT #7 27" SECT #8 30" SECT #9 33" SECT #10 36" SECT #11 39" SECT #12 42"</p>	 <p>18" TOP SECT #5 21" SECT #6 24" SECT #7 27" SECT #8 30" SECT #9 33" SECT #10 36" SECT #11 39" SECT #12 42" SECT #13 45"</p>			
Allowable antenna area in ft <sup>2</sup> at 70/85/100 mph wind*	Survival 1/2" ice	Round: 2/--/-- Flat: 1/--/--	Round: 3/--/-- Flat: 2/--/--	Round: 10/--/-- Flat: 6/--/--	Round: 24/1/-- Flat: 16/1/--			
Shipping Dimensions (LxWxH")		101x60x40	101x64x42	101x67x45	101x75x49			
Shipping Weight (lbs)		780	912	1,047	1,220			

\*Based on the antenna load being centrally located and balanced 3' or less above the tower top ("--" indicates tower failure). Titan Towers are based on survival design and cannot be PEng. Stamped.

## Common Accessories

Accessory:	T200	T300	T400	T500			
<b>Safety Rail System</b> trolley sold separately	4.97.0510.272	4.97.0510.372	4.97.0510.472	4.97.0510.572	 <p>Safety Rail System</p>  <p>Anti-Climb Shield</p>		
<b>Anti-Climb Shield</b> set of 3	4.92.0110.000	4.92.0111.000	4.92.0112.000	4.92.0113.000			
<b>Tower Grounding Kit</b> with #6 copper wire	4.91.0101.000	4.91.0101.000	4.91.0101.000	4.91.0101.000			
<b>Side Mount (Top Section)</b> with 2 angle frames, clip angles, u-bolt assemblies, and 6' pipe	4.84.1141.000	4.84.1142.000	4.84.1151.000	4.84.1152.000			
For more Antenna Side Mount Kits, see accessories page 16.							
<b>Base Foot Weldments</b> set of 3	4.82.0111.000	4.82.0112.000	4.82.0113.000	4.82.0114.000			

For more TITAN Accessories and Replacement Parts, see pages 15 to 24.

# 80' Towers

Model Designation:		T200	T300	T400				
Part Number:		4.95.0209.000	4.95.0309.000	4.95.0409.000				
<p>Includes 4' anchor stub legs for concrete, splice hardware, 8' x 1.9"OD antenna mounting pipe.</p> <p>To support the mounting pipe, every top section is factory installed with angle frames and u-bolts at top and middle of the section.</p> <p>Tower height shown is nominal. Actual tower height is achieved using support pipe provided with tower.</p>								
Allowable antenna area in ft <sup>2</sup> at 70/85/100 mph wind*	Survival 1/2" ice	Round: 2/--/-- Flat: 1/--/--	Round: 3/--/-- Flat: 2/--/--	Round: 10/--/-- Flat: 6/--/--				
Shipping Dimensions (L"xW"xH")		101x64x42	101x67x45	101x75x49				
Shipping Weight (lbs)		936	1,073	1,258				

\*Based on the antenna load being centrally located and balanced 3' or less above the tower top ("--" indicates tower failure). Titan Towers are based on survival design and cannot be P.Eng. Stamped.

## Common Accessories



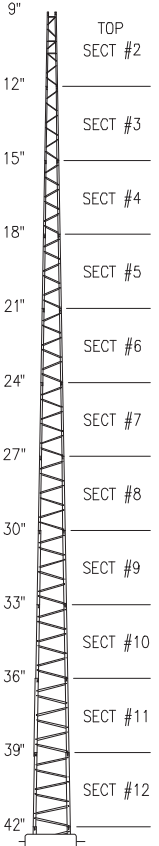
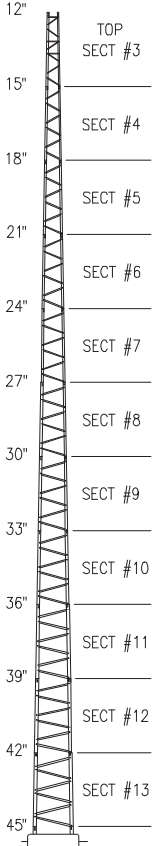

Accessory:	T200	T300	T400				
<b>Safety Rail System</b> trolley sold separately	4.97.0510.280	4.97.0510.380	4.97.0510.480				
<b>Anti-Climb Shield</b> set of 3	4.92.0111.000	4.92.0112.000	4.92.0113.000				
<b>Tower Grounding Kit</b> with #6 copper wire	4.91.0101.000	4.91.0101.000	4.91.0101.000				
<b>Side Mount (Top Section)</b> with 2 angle frames, clip angles, u-bolt assemblies, and 6' pipe	4.84.1141.000	4.84.1142.000	4.84.1151.000				
For more Antenna Side Mount Kits, see accessories page 16.							

For more TITAN Accessories and Replacement Parts, see pages 15 to 24.

Model Designation:		T200	T300				
Part Number:		4.95.0210.000	4.95.0310.000				
<p>Includes 4' anchor stub legs for concrete, splice hardware, 8' x 1.9"OD antenna mounting pipe.</p> <p>To support the mounting pipe, every top section is factory installed with angle frames and u-bolts at top and middle of the section.</p> <p>Tower height shown is nominal. Actual tower height is achieved using support pipe provided with tower.</p>							
Allowable antenna area in ft <sup>2</sup> at 70/85/100 mph wind*	Survival 1/2" ice	Round: 2/--/-- Flat: 1/--/--	Round: 3/--/-- Flat: 2/--/--				
Shipping Dimensions (L"xW"xH")		101x67x45	101x75x49				
Shipping Weight (lbs)		1,098	1,284				

\*Based on the antenna load being centrally located and balanced 3' or less above the tower top ("--" indicates tower failure). Titan Towers are based on survival design and cannot be PEEng. Stamped.

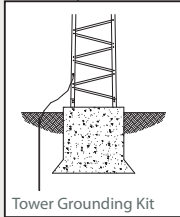
## Common Accessories

Accessory:	T200	T300				
<b>Safety Rail System</b> trolley sold separately	4.97.0510.288	4.97.0510.388				
<b>Anti-Climb Shield</b> set of 3	4.92.0112.000	4.92.0113.000				
<b>Tower Grounding Kit</b> with #6 copper wire	4.91.0101.000	4.91.0101.000				

For more TITAN Accessories and Replacement Parts, see pages 15 to 24.

Model Designation:		T200					
Part Number:		4.95.0211.000					
Includes 4' anchor stub legs for concrete, splice hardware, 8' x 1.9"OD antenna mounting pipe.  Tower height shown is nominal. Actual tower height is achieved using support pipe provided with tower.							
Allowable antenna area in ft <sup>2</sup> at 70/85/100 mph wind*	Survival 1/2" ice	Round: 2/--/-- Flat: 1/--/--					
Shipping Dimensions (L"xW"xH")		101x75x49					
Shipping Weight (lbs)		1,308					

\*Based on the antenna load being centrally located and balanced 3' or less above the tower top ("--" indicates tower failure). Titan Towers are based on survival design and cannot be P.Eng. Stamped.

## Common Accessories

Accessory:	T200					
<b>Safety Rail System</b> trolley sold separately	4.97.0510.296					
<b>Anti-Climb Shield</b> set of 3	4.92.0113.000					
<b>Tower Grounding Kit</b> with #6 copper wire	4.91.0101.000					

For more TITAN Accessories and Replacement Parts, see pages 15 to 24.

### Pre-Assembled 8' Sections (with Splice Hardware to mate with next section)

Part Number	Description	Bare Wt. (lbs)	Ship LxWxH (in)	Image
4.95.0022.000	Tower section # 2 Top c/w hot-dip galv. 1.9"OD x 8' pipe	35	101x40x22	
4.95.0031.000	Tower section # 3	30	101x40x25	
4.95.0032.000	Tower section # 3 Top c/w hot-dip galv. 1.9"OD x 8' pipe	40	101x40x25	
4.95.0041.000	Tower section # 4	38	101x40x28	
4.95.0042.000	Tower section # 4 Top c/w hot-dip galv. 1.9"OD x 8' pipe	53	101x40x28	
4.95.0051.000	Tower section # 5	44	101x40x31	
4.95.0052.000	Tower section # 5 Top c/w hot-dip galv. 1.9"OD x 8' pipe	59	101x40x31	
4.95.0061.000	Tower section # 6	58	101x40x34	
4.95.0062.000	Tower section # 6 Top c/w hot-dip galv. 1.9"OD x 8' pipe	85	101x40x34	
4.95.0071.000	Tower section # 7	71	101x40x37	
4.95.0072.000	Tower section # 7 Top c/w hot-dip galv. 1.9"OD x 8' pipe	91	101x40x37	
4.95.0081.000	Tower section # 8	78	101x40x40	
4.95.0082.000	Tower section # 8 Top c/w hot-dip galv. 1.9"OD x 8' pipe	110	101x40x40	
4.95.0091.000	Tower section # 9	107	101x48x43	
4.95.0101.000	Tower section #10	133	101x48x46	
4.95.0111.000	Tower section #11	148	101x48x49	
4.95.0121.000	Tower section #12	160	101x48x52	
4.95.0131.000	Tower section #13	190	101x48x55	

### Anchor Stub Legs - Set of 3 (4' long, for concrete foundations) (bottom section of tower needs to be on site for install)

Part Number	Description	Ship Wt. (lbs)	Ship LxWxH (in)	Image
4.81.0104.000	Anchor Stub Leg # 4 - fits section # 3	10	48x6x6	
4.81.0105.000	Anchor Stub Leg # 5 - fits section # 4	13	48x6x6	
4.81.0106.000	Anchor Stub Leg # 6 - fits section # 5	16	48x6x6	
4.81.0107.000	Anchor Stub Leg # 7 - fits section # 6	21	48x6x6	
4.81.0108.000	Anchor Stub Leg # 8 - fits section # 7	25	48x6x6	
4.81.0109.000	Anchor Stub Leg # 9 - fits section # 8	28	48x6x6	
4.81.0110.000	Anchor Stub Leg #10 - fits section # 9	40	48x6x6	
4.81.0111.000	Anchor Stub Leg #11 - fits section #10	48	48x6x6	
4.81.0112.000	Anchor Stub Leg #12 - fits section #11	58	48x6x6	
4.81.0113.000	Anchor Stub Leg #13 - fits section #12	75	48x6x6	
4.81.0114.000	Anchor Stub Leg #14 - fits section #13	80	48x6x6	

### 4' Short Foundation Sections (for embedment in concrete; alternate to anchor stub legs)

Part Number	Description	Ship Wt. (lbs)	Ship LxWxH (in)	Image
4.81.0204.000	4' Foundation section - fits section # 3	15	48x48x21	
4.81.0205.000	4' Foundation section - fits section # 4	19	48x48x24	
4.81.0206.000	4' Foundation section - fits section # 5	22	48x48x27	
4.81.0207.000	4' Foundation section - fits section # 6	29	48x48x30	
4.81.0208.000	4' Foundation section - fits section # 7	35	48x48x33	
4.81.0209.000	4' Foundation section - fits section # 8	39	48x48x36	
4.81.0210.000	4' Foundation section - fits section # 9	53	48x48x39	
4.81.0211.000	4' Foundation section - fits section #10	66	48x48x42	
4.81.0212.000	4' Foundation section - fits section #11	75	48x48x45	
4.81.0213.000	4' Foundation section - fits section #12	95	48x48x48	
4.81.0214.000	4' Foundation section - fits section #13	100	48x51x51	



<b>Base Foot Weldments</b> (alternate anchor type to embedment stub legs; use with rock bolts or anchor bolts)				
Part Number	Description	Ship Wt. (lbs)	Ship LxWxH (in)	Image
4.82.0104.000	TITAN Base Foot Weldment # 4 - fits # 3	12	3@5x4x6	
4.82.0105.000	TITAN Base Foot Weldment # 5 - fits # 4	12	3@5x4x6	
4.82.0106.000	TITAN Base Foot Weldment # 6 - fits # 5	12	3@5x4x8	
4.82.0107.000	TITAN Base Foot Weldment # 7 - fits # 6	12	3@5x4x8	
4.82.0108.000	TITAN Base Foot Weldment # 8 - fits # 7	18	3@5x4x8	
4.82.0109.000	TITAN Base Foot Weldment # 9 - fits # 8	18	3@6x5x8	
4.82.0110.000	TITAN Base Foot Weldment #10 - fits # 9	33	3@6x5x8	
4.82.0111.000	TITAN Base Foot Weldment #11 - fits #10	33	3@8x6x8	
4.82.0112.000	TITAN Base Foot Weldment #12 - fits #11	33	3@8x6x8	
4.82.0113.000	TITAN Base Foot Weldment #13 - fits #12	33	3@8x6x8	
4.82.0114.000	TITAN Base Foot Weldment #14 - fits #13	63	3@10x6x8	

<b>Rock Bolts</b> (for sound and solid rock; base foot weldments sold separately)				
Part Number	Description	Ship Wt. (lbs)	Ship LxWxH (in)	Image
4.80.0100.100	5/8" x 5' Rock Bolts, 3-pak - fits # 3 - # 6	22	61x4x5	
4.80.0101.100	3/4" x 5' Rock Bolts, 3-pak - fits # 7 - # 8	24	61x4x5	
4.80.0102.100	1" x 5' Rock Bolts, 3-pak - fits # 9 - #12	45	61x4x5	
4.80.0102.200	1" x 5' Rock Bolts, 6 pak - fits #13	90	2@61x5x5	

Note: Rock bolts above are suitable provided the following rock conditions exist:

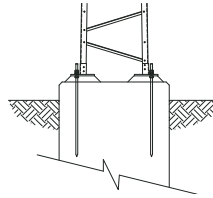

- 1) Rock quality – RQD 90% or better
- 2) Rock unit weight – 180 pcf
- 3) Exposed rock at surface (max 6" of earth cover)

<b>Anchor Bolt Kits</b> (for existing concrete pads and roofs; base foot weldments sold separately – includes bolts, adhesive compound, and hardware)				
Part Number	Description	Ship Wt. (lbs)	Ship LxWxH (in)	Image
4.80.0200.100	Anchor Bolt Kit, 3-pak - fits # 3 - # 6	22	1@36x2x2 + 1@8x8x8	
4.80.0200.200	Anchor Bolt Kit, 3-pak - fits # 7 - # 8	24	1@36x2x2 + 1@8x8x8	
4.80.0200.300	Anchor Bolt Kit, 3-pak - fits # 9 - #12	45	1@36x3x3 + 1@8x8x8	
4.80.0200.400	Anchor Bolt Kit, 6 pak - fits #13	90	1@36x4x4 + 1@8x8x8	

**Side Mount Kit (with 2 angle frames, clip angles, u-bolt assemblies, and 6' pipe)**

Part Number	Description	Ship Wt. (lbs)	Ship LxWxH (in)	Image
4.84.1141.000	Section # 2	22	15x6x6	
4.84.1142.000	Section # 3	23	18x6x6	
4.84.1151.000	Section # 4	25	21x6x6	
4.84.1152.000	Section # 5	27	24x6x6	
4.84.1161.000	Section # 6	28	27x6x6	
4.84.1162.000	Section # 7	29	30x6x6	
4.84.1171.000	Section # 8	31	33x6x6	
4.84.1172.000	Section # 9	33	36x6x6	
4.84.1181.000	Section #10	35	39x6x6	
4.84.1182.000	Section #11	36	42x6x6	
4.84.1191.000	Section #12	37	45x6x6	

**Cluster Antenna Mounts**

Part Number	Description	Ship Wt. (lbs)	Ship LxWxH (in)	Image
4.84.3CLS.00A	3-cluster Antenna Mount, 1.66" OD tube, fits TITAN SS	40	48x10x4	 <i>6-cluster Antenna Mount</i>  <i>3-cluster Antenna Mount</i>
4.84.6CLS.00A	6-cluster Antenna Mount, 1.66" OD tube, fits TITAN SS	80	2@48x10x4	

Note: These cluster mounts install on the top pipe of the TITAN tower. They do **NOT** mount to the legs, they can be side mounted **ONLY** with the addition of a TITAN side-mount kit.

On a 6-cluster mount, the distance from one half of the cluster to the other half is 5.5".

Cluster mounts have built-in down tilt adjustment.

**Surveillance Camera Mounting Accessory (1.9"OD tubing x 6' long)**

Part Number	Description	Ship Wt. (lbs)	Ship LxWxH (in)	Image
4.85.0101.000	Heavy duty flat plate welded at top, hot-dip galvanized	20	60x8x8	

Safety Climb Rail Kits (no trolley)				
Part Number	Description	Ship Wt. (lbs)	Ship LxWxH (in)	Image
4.97.0510.216	Safety Rail Kit for 16' TITAN T200, No Trolley	34	252x6x6	
4.97.0510.224	Safety Rail Kit for 24' TITAN T200, No Trolley	35	252x6x6	
4.97.0510.232	Safety Rail Kit for 32' TITAN T200, No Trolley	37	252x6x6	
4.97.0510.240	Safety Rail Kit for 40' TITAN T200, No Trolley	38	252x6x6	
4.97.0510.248	Safety Rail Kit for 48' TITAN T200, No Trolley	40	252x6x6	
4.97.0510.256	Safety Rail Kit for 56' TITAN T200, No Trolley	42	252x6x6	
4.97.0510.264	Safety Rail Kit for 64' TITAN T200, No Trolley	43	252x6x6	
4.97.0510.272	Safety Rail Kit for 72' TITAN T200, No Trolley	45	252x6x6	
4.97.0510.280	Safety Rail Kit for 80' TITAN T200, No Trolley	47	252x6x6	
4.97.0510.288	Safety Rail Kit for 88' TITAN T200, No Trolley	48	252x6x6	
4.97.0510.296	Safety Rail Kit for 96' TITAN T200, No Trolley	50	252x6x6	
4.97.0510.316	Safety Rail Kit for 16' TITAN T300, No Trolley	34	252x6x6	
4.97.0510.324	Safety Rail Kit for 24' TITAN T300, No Trolley	35	252x6x6	
4.97.0510.332	Safety Rail Kit for 32' TITAN T300, No Trolley	37	252x6x6	
4.97.0510.340	Safety Rail Kit for 40' TITAN T300, No Trolley	38	252x6x6	
4.97.0510.348	Safety Rail Kit for 48' TITAN T300, No Trolley	40	252x6x6	
4.97.0510.356	Safety Rail Kit for 56' TITAN T300, No Trolley	42	252x6x6	
4.97.0510.364	Safety Rail Kit for 64' TITAN T300, No Trolley	43	252x6x6	
4.97.0510.372	Safety Rail Kit for 72' TITAN T300, No Trolley	45	252x6x6	
4.97.0510.380	Safety Rail Kit for 80' TITAN T300, No Trolley	47	252x6x6	
4.97.0510.388	Safety Rail Kit for 88' TITAN T300, No Trolley	48	252x6x6	
4.97.0510.416	Safety Rail Kit for 16' TITAN T400, No Trolley	34	252x6x6	
4.97.0510.424	Safety Rail Kit for 24' TITAN T400, No Trolley	35	252x6x6	
4.97.0510.432	Safety Rail Kit for 32' TITAN T400, No Trolley	37	252x6x6	
4.97.0510.440	Safety Rail Kit for 40' TITAN T400, No Trolley	38	252x6x6	
4.97.0510.448	Safety Rail Kit for 48' TITAN T400, No Trolley	40	252x6x6	
4.97.0510.456	Safety Rail Kit for 56' TITAN T400, No Trolley	42	252x6x6	
4.97.0510.464	Safety Rail Kit for 64' TITAN T400, No Trolley	43	252x6x6	
4.97.0510.472	Safety Rail Kit for 72' TITAN T400, No Trolley	45	252x6x6	
4.97.0510.480	Safety Rail Kit for 80' TITAN T400, No Trolley	47	252x6x6	
4.97.0510.516	Safety Rail Kit for 16' TITAN T500, No Trolley	34	252x6x6	
4.97.0510.524	Safety Rail Kit for 24' TITAN T500, No Trolley	35	252x6x6	
4.97.0510.532	Safety Rail Kit for 32' TITAN T500, No Trolley	37	252x6x6	

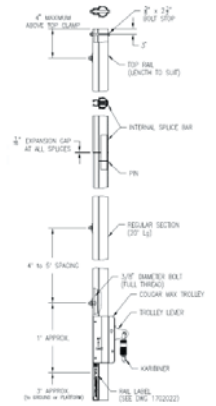

## Safety Climb Rail Kits (no trolley)

Part Number	Description	Ship Wt. (lbs)	Ship LxWxH (in)	Image
4.97.0510.540	Safety Rail Kit for 40' TITAN T500, No Trolley	38	252x6x6	
4.97.0510.548	Safety Rail Kit for 48' TITAN T500, No Trolley	40	252x6x6	
4.97.0510.556	Safety Rail Kit for 56' TITAN T500, No Trolley	42	252x6x6	
4.97.0510.564	Safety Rail Kit for 64' TITAN T500, No Trolley	43	252x6x6	
4.97.0510.572	Safety Rail Kit for 72' TITAN T500, No Trolley	45	252x6x6	
4.97.0510.616	Safety Rail Kit for 16' TITAN T600, No Trolley	34	252x6x6	
4.97.0510.624	Safety Rail Kit for 24' TITAN T600, No Trolley	35	252x6x6	
4.97.0510.632	Safety Rail Kit for 32' TITAN T600, No Trolley	37	252x6x6	
4.97.0510.640	Safety Rail Kit for 40' TITAN T600, No Trolley	38	252x6x6	
4.97.0510.648	Safety Rail Kit for 48' TITAN T600, No Trolley	40	252x6x6	
4.97.0510.656	Safety Rail Kit for 56' TITAN T600, No Trolley	42	252x6x6	
4.97.0510.664	Safety Rail Kit for 64' TITAN T600, No Trolley	43	252x6x6	
4.97.0510.716	Safety Rail Kit for 16' TITAN T700, No Trolley	34	252x6x6	
4.97.0510.724	Safety Rail Kit for 24' TITAN T700, No Trolley	35	252x6x6	
4.97.0510.724	Safety Rail Kit for 32' TITAN T700, No Trolley	37	252x6x6	
4.97.0510.740	Safety Rail Kit for 40' TITAN T700, No Trolley	38	252x6x6	
4.97.0510.748	Safety Rail Kit for 48' TITAN T700, No Trolley	40	252x6x6	
4.97.0510.756	Safety Rail Kit for 56' TITAN T700, No Trolley	42	252x6x6	
4.97.0510.816	Safety Rail Kit for 16' TITAN T800, No Trolley	34	252x6x6	
4.97.0510.824	Safety Rail Kit for 24' TITAN T800, No Trolley	35	252x6x6	
4.97.0510.832	Safety Rail Kit for 32' TITAN T800, No Trolley	37	252x6x6	
4.97.0510.840	Safety Rail Kit for 40' TITAN T800, No Trolley	38	252x6x6	
4.97.0510.848	Safety Rail Kit for 48' TITAN T800, No Trolley	40	252x6x6	

## Safety Harness

Part Number	Description	Ship Wt. (lbs)	Ship LxWxH (in)	Image
4.96.0100.000	Universal Safety Harness	5	16x16x8	

## Cougar Max Trolley

Part Number	Description	Ship Wt. (lbs)	Ship LxWxH (in)	Image
4.957.0042.001	COUGAR 3.0 Trolley w/Karabiner	5	8x8x8	

<b>Amateur Radio Mounts (rotor plates for thrust bearing)</b>				
<b>Part Number</b>	<b>Description</b>	<b>Ship Wt. (lbs)</b>	<b>Ship LxWxH (in)</b>	<b>Image</b>
4.89.0121.000	Rotor Plate, galvanized - top section # 2	8	15x15x1	
4.89.0122.000	Rotor Plate, galvanized - middle section # 2	9	16x16x1	
4.89.0131.000	Rotor Plate, galvanized - top section # 3	10	18x18x1	
4.89.0132.000	Rotor Plate, galvanized - middle section # 3	11	20x20x1	
4.89.0141.000	Rotor Plate, galvanized - top section # 4	14	22x22x1	
4.89.0142.000	Rotor Plate, galvanized - middle section # 4	15	24x24x1	
4.89.0151.000	Rotor Plate, galvanized - top section # 5	17	26x26x1	
4.89.0152.000	Rotor Plate, galvanized - middle section # 5	18	28x28x1	
4.89.0161.000	Rotor Plate, galvanized - top section # 6	19	30x30x1	
4.89.0162.000	Rotor Plate, galvanized - middle section # 6	20	32x32x1	
4.89.0171.000	Rotor Plate, galvanized - top section # 7	22	34x34x1	
4.89.0172.000	Rotor Plate, galvanized - middle section # 7	24	36x36x1	
4.89.0181.000	Rotor Plate, galvanized - top section # 8	28	38x38x1	
4.89.0182.000	Rotor Plate, galvanized - middle section # 8	30	40x40x1	

Note: If you are buying a Radio Mount for anything other than a top section, you must also purchase angle frames.

<b>Angle Frames (with Hardware and U-bolts)</b>				
<b>Part Number</b>	<b>Description</b>	<b>Ship Wt. (lbs)</b>	<b>Ship LxWxH (in)</b>	<b>Image</b>
4.83.0121.000	Angle Frame - top section # 2	5	15x15x1	
4.83.0122.000	Angle Frame - middle section # 2	5	16x16x1	
4.83.0122.100	Angle Frame - top and middle section # 2	10	16x16x1	
4.83.0131.000	Angle Frame - top section # 3	5	20x20x1	
4.83.0132.000	Angle Frame - middle section # 3	5	20x20x1	
4.83.0132.100	Angle Frame - top and middle section # 3	10	20x20x1	
4.83.0141.000	Angle Frame - top section # 4	8	24x24x1	
4.83.0142.000	Angle Frame - middle section # 4	8	24x24x1	
4.83.0142.100	Angle Frame - top and middle section # 4	15	24x24x1	
4.83.0151.000	Angle Frame - top section # 5	8	28x28x1	
4.83.0152.000	Angle Frame - middle section # 5	8	28x28x1	
4.83.0152.100	Angle Frame - top and middle section # 5	15	28x28x1	
4.83.0161.000	Angle Frame - top section # 6	10	32x32x1	
4.83.0162.000	Angle Frame - middle section # 6	10	32x32x1	
4.83.0162.100	Angle Frame - top and middle section # 6	20	32x32x1	
4.83.0171.000	Angle Frame - top section # 7	10	36x36x1	
4.83.0172.000	Angle Frame - middle section # 7	10	36x36x1	
4.83.0172.100	Angle Frame - top and middle section # 7	20	36x36x1	
4.83.0181.000	Angle Frame - top section # 8	13	40x40x1	
4.83.0182.000	Angle Frame - middle section # 8	13	40x40x1	
4.83.0182.100	Angle Frame - top and middle section # 8	25	40x40x1	

### Working Platforms

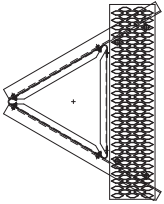
Part Number	Description	Ship Wt. (lbs)	Ship LxWxH (in)	Image
4.88.0102.230	Fits sections # 2 and # 3	50	32x10x4	
4.88.0102.456	Fits sections #4, # 5, and # 6	55	40x42x12	
4.88.0102.780	Fits sections # 7 and # 8	60	40x42x12	

### Lightning Rod

Part Number	Description	Ship Wt. (lbs)	Ship LxWxH (in)	Image
4.90.0100.000	Lightning Rod	10	96x6x6	

### Antenna Mounting Pipes (for top of tower)

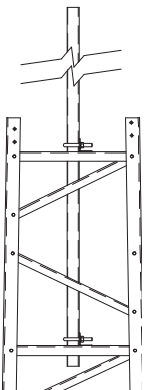
Part Number	Description	Ship Wt. (lbs)	Ship LxWxH (in)	Image
4.87.0101.000	1.9"OD Galv. Tubing x 6', sched. 40, inside diameter=1.625"	14	72x2x2	
4.87.0101.100	1.9"OD Galv. Tubing x 8', sched. 40, inside diameter=1.625"	18	96x2x2	
4.87.0101.200	1.9"OD Galv. Tubing x 10', sched. 40, inside diameter=1.625"	23	120x2x2	
4.87.0101.300	1.9"OD Galv. Tubing x 12', sched. 40, inside diameter=1.625"	28	144x2x2	
4.87.0102.000	2.375"OD Galvanized Tubing x 6', sched. 40	28	72x2.5x2.5	
4.87.0102.100	2.375"OD Galvanized Tubing x 8', sched. 40	37	96x2.5x2.5	
4.87.0102.200	2.375"OD Galvanized Tubing x 10', sched. 40	46	120x2.5x2.5	
4.87.0102.300	2.375"OD Galvanized Tubing x 12', sched. 40	56	144x2.5x2.5	
4.87.0103.000	2.875"OD Galvanized Tubing x 6', sched. 40	34	72x3x3	
4.87.0103.100	2.875"OD Galvanized Tubing x 8', sched. 40	46	96x3x3	
4.87.0103.200	2.875"OD Galvanized Tubing x 10', sched. 40	57	120x3x3	
4.87.0103.300	2.875"OD Galvanized Tubing x 12', sched. 40	68	144x3x3	

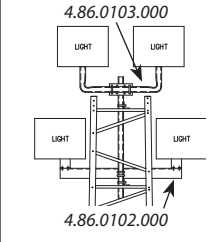
<b>Flood Light Supports</b> (for ballpark, stadium, and parking lot lighting)				
Part Number	Description	Ship Wt. (lbs)	Ship LxWxH (in)	Image
4.86.0103.000	Dual Light Bullhorn Mount, 30" wide	12	30x18x3	
4.86.0102.000	Dual Light Angle Mount, 48" wide	34	48x18x6	

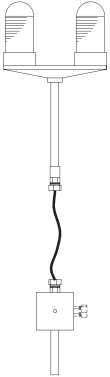
<b>Lighting Kits</b> (steady burning, dual red, non-alarmed)				
Part Number	Description	Ship Wt. (lbs)	Ship LxWxH (in)	Image
4.93.0102.000	16' Lighting Kit with Tech 90 cable	53	40x42x12	
4.93.0103.000	24' Lighting Kit with Tech 90 cable	55	40x42x12	
4.93.0104.000	32' Lighting Kit with Tech 90 cable	57	40x42x12	
4.93.0105.000	40' Lighting Kit with Tech 90 cable	58	40x42x16	
4.93.0106.000	48' Lighting Kit with Tech 90 cable	60	40x42x16	
4.93.0107.000	56' Lighting Kit with Tech 90 cable	60	40x42x18	
4.93.0108.000	64' Lighting Kit with Tech 90 cable	65	40x42x18	
4.93.0109.000	72' Lighting Kit with Tech 90 cable	67	40x42x20	
4.93.0110.000	80' Lighting Kit with Tech 90 cable	68	40x42x20	
4.93.0111.000	88' Lighting Kit with Tech 90 cable	69	40x42x24	
4.93.0112.000	96' Lighting Kit with Tech 90 cable	70	40x42x24	

<b>TITAN Replacement Bulbs</b>				
Part Number	Description	Ship Wt. (lbs)	Ship LxWxH (in)	Image
1404070	TITAN Red Obstruction Bulbs	0.5	10x10x10	

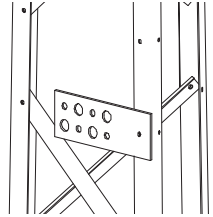
<b>TITAN Transmission Line Support Bracket</b> (1 pak, order 3 per section)				
Part Number	Description	Ship Wt. (lbs)	Ship LxWxH (in)	Image
4.84.0300.200	TITAN Tx Bracket	1	6x4x2	

**Diagonal Braces** (nuts and bolts sold separately, always replace nuts when replacing braces, do not re-use)

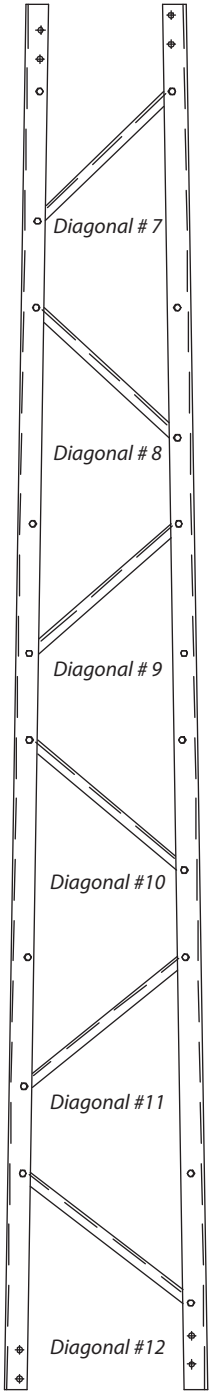
Part Number	Description	Ship Wt. (lbs)	Ship LxWxH (in)	Image
3.85.0022.107	TITAN SS Tower Diagonal # 7 (section # 2)	1	13x1x0.5	
3.85.0022.108	TITAN SS Tower Diagonal # 8 (section # 2)	1	15x1x0.5	
3.85.0022.109	TITAN SS Tower Diagonal # 9 (section # 2)	1	15x1x0.5	
3.85.0022.110	TITAN SS Tower Diagonal #10 (section # 2)	1	15x1x0.5	
3.85.0022.111	TITAN SS Tower Diagonal #11 (section # 2)	2	16x1x0.5	
3.85.0022.112	TITAN SS Tower Diagonal #12 (section # 2)	2	16x1x0.5	
3.85.0022.113	TITAN SS Tower Diagonal #13 (section # 3)	2	17x1x0.75	
3.85.0022.114	TITAN SS Tower Diagonal #14 (section # 3)	2	17x1x0.75	
3.85.0022.115	TITAN SS Tower Diagonal #15 (section # 3)	2	17x1x0.75	
3.85.0022.116	TITAN SS Tower Diagonal #16 (section # 3)	2	18x1x0.75	
3.85.0022.117	TITAN SS Tower Diagonal #17 (section # 3)	2	18x1x0.75	
3.85.0022.118	TITAN SS Tower Diagonal #18 (section # 3)	2	19x1x0.75	
3.85.0022.119	TITAN SS Tower Diagonal #19 (section # 4)	2	19x1x0.75	
3.85.0022.120	TITAN SS Tower Diagonal #20 (section # 4)	2	20x1x0.75	
3.85.0022.121	TITAN SS Tower Diagonal #21 (section # 4)	2	20x1x0.75	
3.85.0022.122	TITAN SS Tower Diagonal #22 (section # 4)	2	20x1x0.75	
3.85.0022.123	TITAN SS Tower Diagonal #23 (section # 4)	2	21x1x0.75	
3.85.0022.124	TITAN SS Tower Diagonal #24 (section # 4)	2	21x1x0.75	
3.85.0022.125	TITAN SS Tower Diagonal #25 (section # 5)	2	22x1.25x1	
3.85.0022.126	TITAN SS Tower Diagonal #26 (section # 5)	2	22x1.25x1	
3.85.0022.127	TITAN SS Tower Diagonal #27 (section # 5)	2	23x1.25x1	
3.85.0022.128	TITAN SS Tower Diagonal #28 (section # 5)	2	23x1.25x1	
3.85.0022.129	TITAN SS Tower Diagonal #29 (section # 5)	2	24x1.25x1	
3.85.0022.130	TITAN SS Tower Diagonal #30 (section # 5)	2	24x1.25x1	
3.85.0022.131	TITAN SS Tower Diagonal #31 (section # 6)	2	24x1.25x1	
3.85.0022.132	TITAN SS Tower Diagonal #32 (section # 6)	2	25x1.25x1	
3.85.0022.133	TITAN SS Tower Diagonal #33 (section # 6)	2	25x1.25x1	
3.85.0022.134	TITAN SS Tower Diagonal #34 (section # 6)	2	25x1.25x1	
3.85.0022.135	TITAN SS Tower Diagonal #35 (section # 6)	2	26x1.25x1	
3.85.0022.136	TITAN SS Tower Diagonal #36 (section # 6)	2	27x1.25x1	
3.85.0022.137	TITAN SS Tower Diagonal #37 (section # 7)	2	27x1.25x1	
3.85.0022.138	TITAN SS Tower Diagonal #38 (section # 7)	2	28x1.25x1	
3.85.0022.139	TITAN SS Tower Diagonal #39 (section # 7)	2	28x1.25x1	
3.85.0022.140	TITAN SS Tower Diagonal #40 (section # 7)	2	29x1.25x1	
3.85.0022.141	TITAN SS Tower Diagonal #41 (section # 7)	2	29x1.25x1	
3.85.0022.142	TITAN SS Tower Diagonal #42 (section # 7)	2	30x1.25x1	
3.85.0022.143	TITAN SS Tower Diagonal #43 (section # 8)	2	30x1.25x1	
3.85.0022.144	TITAN SS Tower Diagonal #44 (section # 8)	2	31x1.25x1	
3.85.0022.145	TITAN SS Tower Diagonal #45 (section # 8)	2	31x1.25x1	
3.85.0022.146	TITAN SS Tower Diagonal #46 (section # 8)	2	31x1.25x1	
3.85.0022.147	TITAN SS Tower Diagonal #47 (section # 8)	2	32x1.25x1	
3.85.0022.148	TITAN SS Tower Diagonal #48 (section # 8)	2	32x1.25x1	
3.85.0022.149	TITAN SS Tower Diagonal #49 (section # 9)	3	33x1.5x1.25	
3.85.0022.150	TITAN SS Tower Diagonal #50 (section # 9)	3	33x1.5x1.25	
3.85.0022.151	TITAN SS Tower Diagonal #51 (section # 9)	3	34x1.5x1.25	
3.85.0022.152	TITAN SS Tower Diagonal #52 (section # 9)	3	34x1.5x1.25	
3.85.0022.153	TITAN SS Tower Diagonal #53 (section # 9)	3	35x1.5x1.25	
3.85.0022.154	TITAN SS Tower Diagonal #54 (section # 9)	3	35x1.5x1.25	
3.85.0022.155	TITAN SS Tower Diagonal #55 (section #10)	3	36x1.5x1.25	
3.85.0022.156	TITAN SS Tower Diagonal #56 (section #10)	4	36x1.5x1.25	
3.85.0022.157	TITAN SS Tower Diagonal #57 (section #10)	4	37x1.5x1.25	
3.85.0022.158	TITAN SS Tower Diagonal #58 (section #10)	4	37x1.5x1.25	
3.85.0022.159	TITAN SS Tower Diagonal #59 (section #10)	4	38x1.5x1.25	



<b>Diagonal Braces</b> (nuts and bolts sold separately, always replace nuts when replacing braces, do not re-use)				
Part Number	Description	Ship Wt. (lbs)	Ship LxWxH (in)	Image
3.85.0022.160	TITAN SS Tower Diagonal #60 (section #10)	4	38x1.5x1.25	See page 22.
3.85.0022.161	TITAN SS Tower Diagonal #61 (section #11)	4	38x1.75x1.25	
3.85.0022.162	TITAN SS Tower Diagonal #62 (section #11)	4	38x1.75x1.25	
3.85.0022.163	TITAN SS Tower Diagonal #63 (section #11)	4	39x1.75x1.25	
3.85.0022.164	TITAN SS Tower Diagonal #64 (section #11)	4	39x1.75x1.25	
3.85.0022.165	TITAN SS Tower Diagonal #65 (section #11)	4	40x1.75x1.25	
3.85.0022.166	TITAN SS Tower Diagonal #66 (section #11)	4	40x1.75x1.25	
3.85.0022.167	TITAN SS Tower Diagonal #67 (section #12)	4	41x1.75x1.25	
3.85.0022.168	TITAN SS Tower Diagonal #68 (section #12)	5	41x1.75x1.25	
3.85.0022.169	TITAN SS Tower Diagonal #69 (section #12)	5	42x1.75x1.25	
3.85.0022.170	TITAN SS Tower Diagonal #70 (section #12)	5	42x1.75x1.25	
3.85.0022.171	TITAN SS Tower Diagonal #71 (section #12)	5	43x1.75x1.25	
3.85.0022.172	TITAN SS Tower Diagonal #72 (section #12)	5	43x1.75x1.25	
3.85.0022.173	TITAN SS Tower Diagonal #73 (section #13)	5	46x2x2	
3.85.0022.174	TITAN SS Tower Diagonal #74 (section #13)	5	46x2x2	
3.85.0022.175	TITAN SS Tower Diagonal #75 (section #13)	5	46x2x2	
3.85.0022.176	TITAN SS Tower Diagonal #76 (section #13)	5	47x2x2	
3.85.0022.177	TITAN SS Tower Diagonal #77 (section #13)	5	47x2x2	
3.85.0022.178	TITAN SS Tower Diagonal #78 (section #13)	5	48x2x2	

<b>Replacement Nuts and Washers for Diagonal Braces</b> (minimum order: 200 pieces)				
Part Number	Description	Ship Wt. (lbs)	Ship LxWxH (in)	Image
1205020	1/4" Kep Nut and Integral Washer	0.01	8x8x8	
1205040	5/16" Kep Nut and Integral Washer	0.01	8x8x8	
1205060	3/8" Kep Nut and Integral Washer	0.02	8x8x8	

<b>Replacement Bolts for Diagonal Braces</b> (minimum order: 200 pieces)				
Part Number	Description	Ship Wt. (lbs)	Ship LxWxH (in)	Image
1205010	1/4" x 1/2" Bolt for braces - fits # 7-48	0.02	12x12x12	
1205011	1/4" x 3/4" Bolt for braces/angle frames	0.02	12x12x12	
1205030	5/16" x 3/4" Bolt for braces - fits #49-72	0.02	12x12x12	
1205050	3/8" x 3/4" Bolt for braces - fits #73-78	0.03	12x12x12	

### Replacement Tower Legs (hardware sold separately; UPS shippable)

Part Number	Description	Ship Wt. (lbs)	Ship LxWxH (in)	Image
3.85.0021.002	TITAN SS Tower Leg # 2	7	96x2.3x1.7	
3.85.0021.003	TITAN SS Tower Leg # 3	8	96x2.3x1.7	
3.85.0021.004	TITAN SS Tower Leg # 4	10	96x2.9x2	
3.85.0021.005	TITAN SS Tower Leg # 5	10	96x3x2.2	
3.85.0021.006	TITAN SS Tower Leg # 6	15	96x3x2.2	
3.85.0021.007	TITAN SS Tower Leg # 7	16	96x3.6x2.5	
3.85.0021.008	TITAN SS Tower Leg # 8	18	96x3.9x2.8	
3.85.0021.009	TITAN SS Tower Leg # 9	20	96x4.3x3	
3.85.0021.010	TITAN SS Tower Leg #10	26	96x4.6x3.25	
3.85.0021.011	TITAN SS Tower Leg #11	28	96x5x3.5	
3.85.0021.012	TITAN SS Tower Leg #12	29	96x5.3x3.75	
3.85.0021.013	TITAN SS Tower Leg #13	36	96x5.7x4	

### Splice Bolt Kits (for attaching tower sections together)

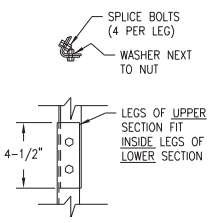
Part Number	Description	Ship Wt. (lbs)	Ship LxWxH (in)	Image
4.78.0212.000	For connecting sections # 2 to # 3	0.4	6x4x2	
4.78.0211.000	For connecting sections # 3 to # 4	0.4	6x4x2	
4.78.0210.000	For connecting sections # 4 to # 5	0.4	6x4x2	
4.78.0209.000	For connecting sections # 5 to # 6	0.4	6x4x2	
4.78.0208.000	For connecting sections # 6 to # 7	0.4	6x4x2	
4.78.0207.000	For connecting sections # 7 to # 8	1.0	6x4x2	
4.78.0206.000	For connecting sections # 8 to # 9	1.0	6x4x2	
4.78.0205.000	For connecting sections # 9 to # 10	1.2	6x4x2	
4.78.0204.000	For connecting sections # 10 to # 11	1.2	6x4x2	
4.78.0203.000	For connecting sections # 11 to # 12	4.2	6x4x2	
4.78.0202.000	For connecting sections # 12 to # 13	4.2	6x4x2	
4.78.0201.000	For connecting sections # 13 to Anchor Stub Leg #14	4.2	6x4x2	
4.78.0202.200	Complete Splice Kit for 96' T200	19	16x16x12	

# Concrete Foundation Details TITAN<sup>®</sup> TOWER SELF-SUPPORT

(Normal dry soil)

How to use this page:

1. Determine what section number is at the bottom of your specific tower model.
2. Using "Chart A", find the anchor type that corresponds to the bottom section of your tower.
3. Using "Chart B", find dimensions that match your anchor type.

Chart A

If Bottom Tower Section Is:	Use Anchor Type from Chart B
#3	1
#4	1
#5	1
#6	1
#7	2
#8	2
#9	3
#10	3
#11	3
#12	3
#13	4

Chart B

ANCHOR TYPE	"B" (FEET)	"W" (FEET)	"L" (FEET)	"X" HORIZONTAL REINFORCING	"Y" VERTICAL REINFORCING	OVERTURNING MOMENT (FT. KIPS)	SHEAR (KIPS)	CONCRETE VOLUME CUBIC YARDS
1	3	4	4	4	16	17	0.7	2.0
2	4	5	5	5	20	28	1.0	4.0
3	5	7	5	5	20	67	1.7	6.0
4	5.5	7.5	5.5	6	24	105	3.0	7.0

Visit [www.trylon.com](http://www.trylon.com) for full foundation installation details, including foundation notes.

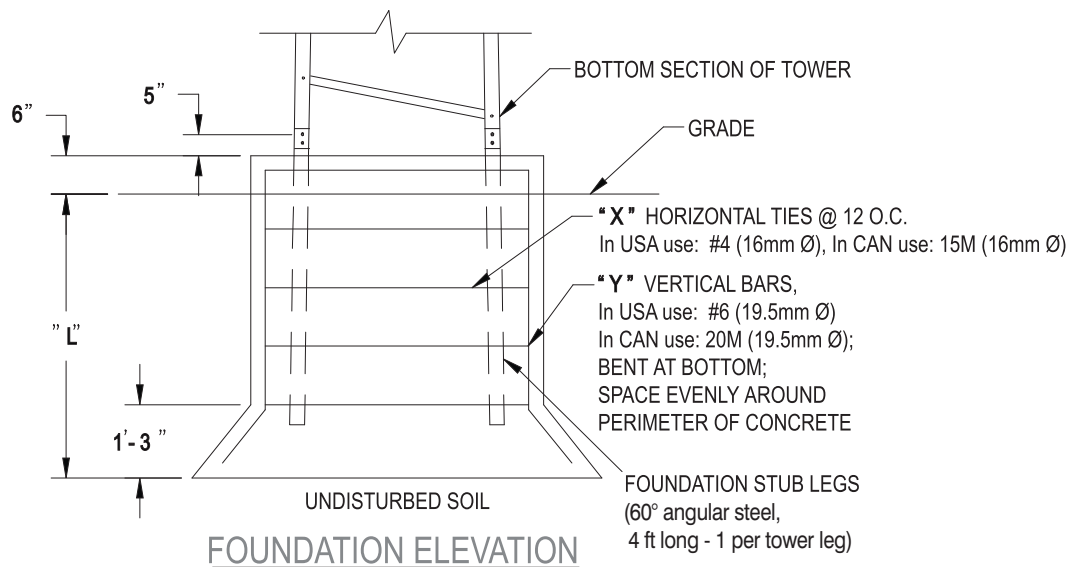
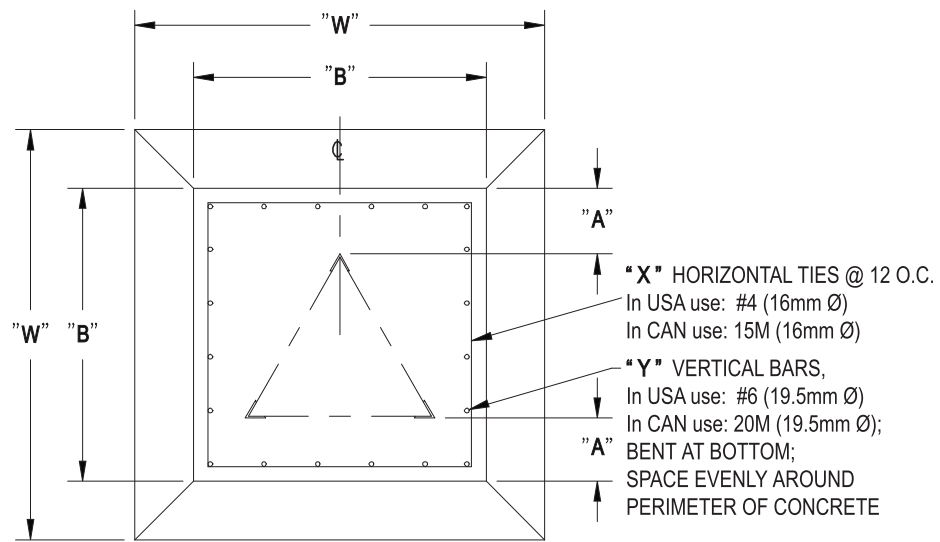

# TITAN<sup>®</sup>TOWER SELF-SUPPORT Concrete Foundation Details

(For applications with weak soil or shallow water table)

PLAN VIEW

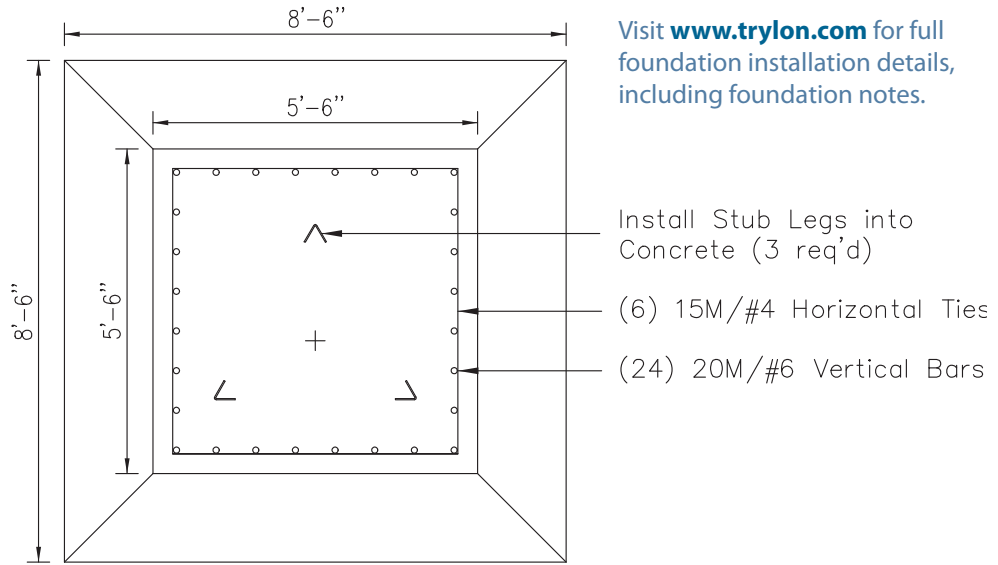

ELEV VIEW

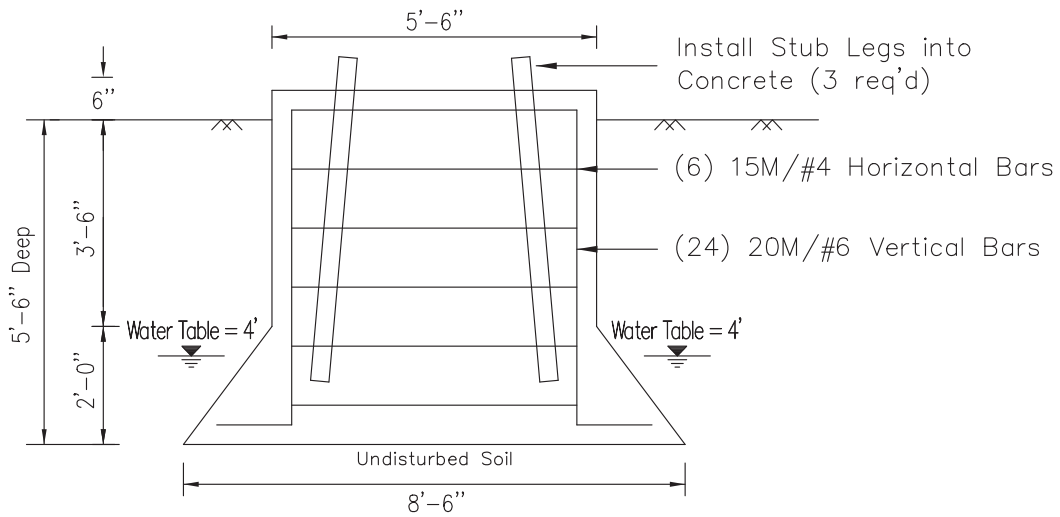

Overturing Moment	= 105 k-ft
Horizontal Shear	= 3.0 kips

**Notes:**

- Assumed Soil Parameters:  
 Allowable Soil Capacity = 2.0 ksf\*  
 Water table at 4' depth below surface\*  
 Dry density of 100 pcf  
 K<sub>p</sub> - K<sub>a</sub> = 2.7  
 Friction angle of 30°
- This drawing illustrates a foundation for TITAN SS Towers using bottom section #13.

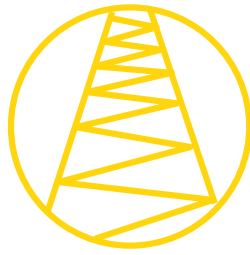

**SUPER  
TITAN™** **KD**

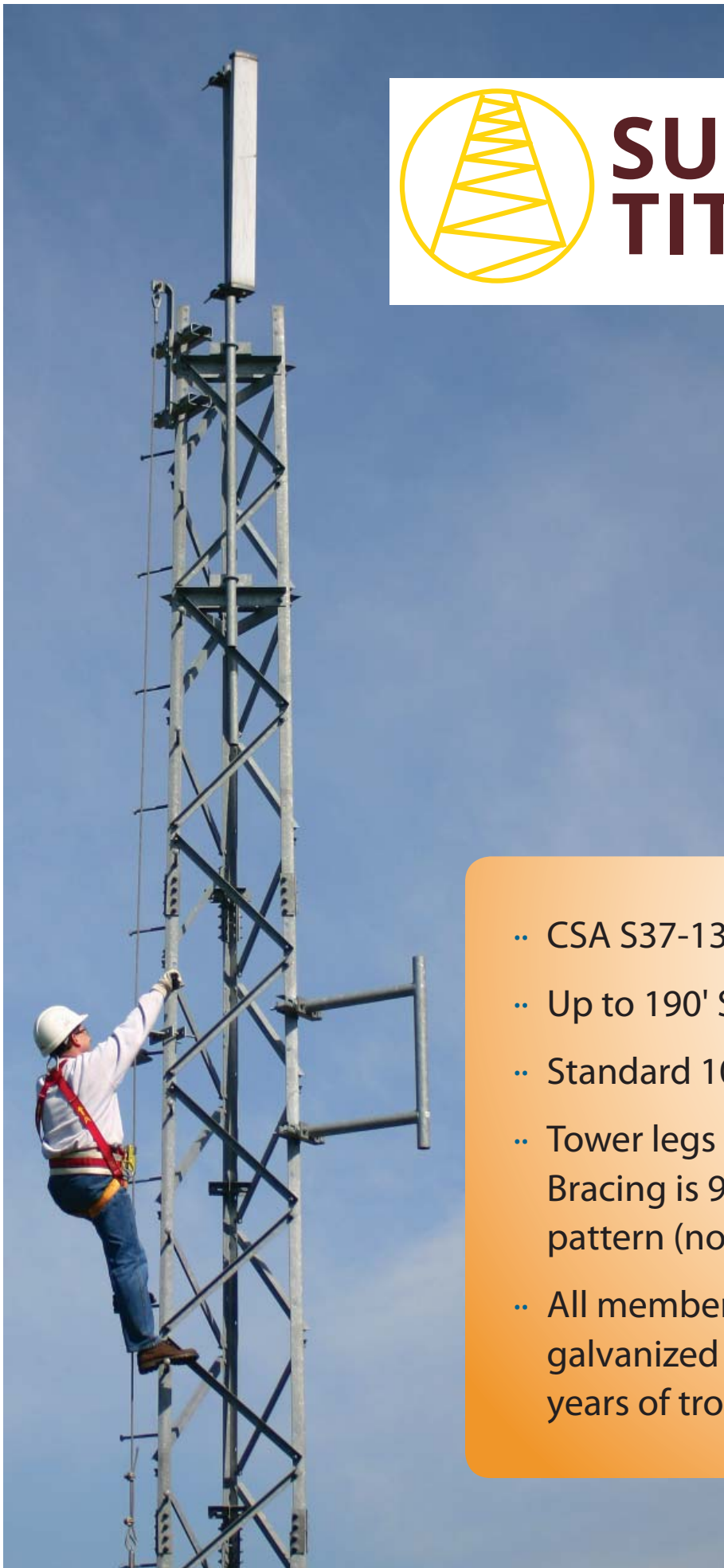

- .. CSA S37-13 compliant
- .. Up to 190' Self-Support Tower
- .. Standard 10' sections
- .. Tower legs are 60° angle.  
Bracing is 90° angle on a diagonal  
pattern (no horizontals)
- .. All members are hot-dip  
galvanized throughout to provide  
years of trouble free service

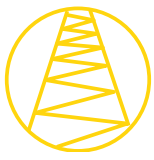

## Explanation of CSA Class 1 vs Class 3 Wind Loading

- The following pages contain wind loading specifications for each tower model. The wind load capacity is expressed as the “maximum allowable antenna area” that can be placed at the tower top, based on a specific wind pressure.
- The term “antenna area” refers to the surface area of the antenna that’s exposed to wind.
- For example, a flat panel antenna will have a projected surface area roughly equivalent to the Length x Width of the largest surface. In the example pictured on the right, the projected surface area would equal, Length (2') x Width (1') = 2'.
- The pages also provide allowable antenna areas based upon CSA Class 1, and CSA Class 3. The Class 3 design offers greater strength capacity for each tower.
- A simple guide line for interpreting when a tower installation would be considered Class 1 or Class 3 is shown in the table below.

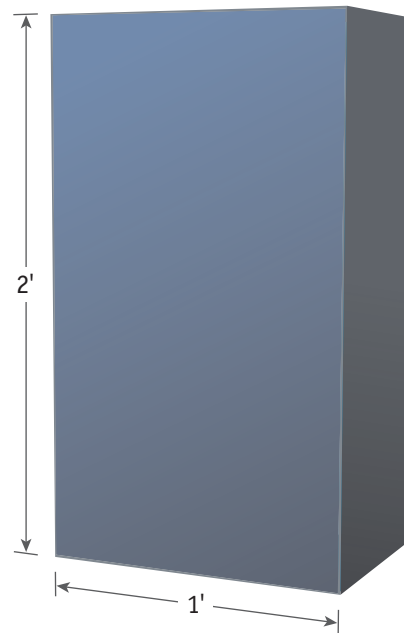

Reliability Class	Importance Factor	Classification Criteria
<b>1</b>	1.0	Failure would result in risk of injury or unacceptable disruption of service.
<b>2</b>	0.9	Failure would result in negligible risk of injury. Loss of service is not critical.
<b>3</b>	0.8	All consequences of failure are tolerable. No foreseeable risk of injury.

# 20' Towers



Model Designation:	S100	S200	S300	S400	S500		
Knocked-down Part Number:	5.94.0100.020	5.94.0200.020	5.94.0300.020	5.94.0400.020	5.94.0500.020		
Assembled Part Number:	5.95.0100.020	5.95.0200.020	5.95.0300.020	5.95.0400.020	5.95.0500.020		
Includes 5' embedment section for concrete foundation, splice hardware, and pipe anchor brackets for antenna mounting pipe (pipe sold separately on page 70).  Knocked-down towers reduce shipping cost in comparison with pre-assembled.							
Allowable antenna area in ft <sup>2</sup> at*	CSA Class 1** 10mm ice (350/450/550 Pa)	Round: 80/60/47 Flat: 57/42/33	Round: 93/70/55 Flat: 66/50/39	Round: 107/82/65 Flat: 76/58/46	Round: 121/93/73 Flat: 86/66/52	Round: 167/128/101 Flat: 119/91/72	
	CSA Class 1** 25mm ice (350/450/550 Pa)	Round: 80/60/47 Flat: 57/42/33	Round: 93/70/55 Flat: 66/50/39	Round: 109/82/65 Flat: 76/58/46	Round: 121/93/73 Flat: 86/66/52	Round: 167/128/101 Flat: 119/91/72	
	CSA Class 3** 25mm ice (350/450/550 Pa)	Round: 100/76/61 Flat: 67/51/41	Round: 120/92/74 Flat: 80/61/49	Round: 140/105/74 Flat: 93/70/56	Round: 156/120/96 Flat: 104/80/64	Round: 335/260/210 Flat: 223/173/140	
Knocked-down Towers	L"xW"xH"	133x48x15	133x48x15	133x48x15	133x48x15	133x48x16	
Assembled Towers	L"xW"xH"	133x48x24	133x48x28	133x48x31	133x60x34	133x60x43	
Shipping Weight (lbs)	565	578	597	624	731		

\*Assumptions: Projected areas (PA) shown are bare; a 1.5 multiplier used for iced area; loads centrally located and balanced at tower top; considers step-pegs, safety cable, and one 1/2" tx line per 10 sq.ft.; "-" indicates tower failure.  
\*\* For examples of CSA Class 1 vs Class 3, see page 28.

## Common Accessories

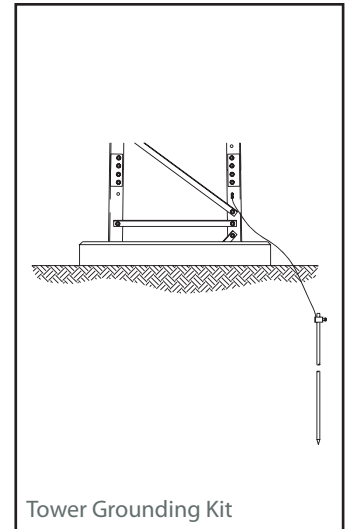

Accessory:	S100	S200	S300	S400	S500		
<b>Cable Safety Climb Kits</b> no slider	4.99.0485.050	4.99.0485.050	4.99.0485.050	4.99.0485.050	4.99.0485.050		
<b>Step-Bolt Kit</b> leg mounted	4.98.0100.020	4.98.0100.020	4.98.0100.020	4.98.0100.020	4.98.0100.020		
<b>Anti-Climb Shield Kits</b>	4.92.0001.002	4.92.0001.003	4.92.0001.004	4.92.0001.005	4.92.0001.006		
<b>Tower Grounding Kit</b> basic, single leg	4.91.0103.000	4.91.0103.000	4.91.0103.000	4.91.0103.000	4.91.0103.000		

For more SuperTITAN Accessories and Replacement Parts, see pages 61 to 76.

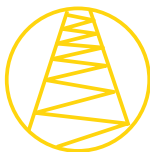

Model Designation:		S100	S200	S300	S400	S500
Knocked-down Part Number:		5.94.0100.030	5.94.0200.030	5.94.0300.030	5.94.0400.030	5.94.0500.030
Assembled Part Number:		5.95.0100.030	5.95.0200.030	5.95.0300.030	5.95.0400.030	5.95.0500.030
Includes 5' embedment section for concrete foundation, splice hardware, and pipe anchor brackets for antenna mounting pipe (pipe sold separately on page 70).  Knocked-down towers reduce shipping cost in comparison with pre-assembled.						
Allowable antenna area in ft <sup>2</sup> at*	CSA Class 1** 10mm ice (350/450/550 Pa)	Round: 44/30/22 Flat: 31/21/15	Round: 52/37/26 Flat: 37/26/18	Round: 59/41/31 Flat: 42/29/22	Round: 111/85/67 Flat: 79/60/47	Round: 150/111/87 Flat: 107/79/62
	CSA Class 1** 25mm ice (350/450/550 Pa)	Round: 40/29/20 Flat: 28/20/14	Round: 50/37/26 Flat: 35/26/18	Round: 59/41/31 Flat: 42/29/22	Round: 111/85/67 Flat: 79/60/47	Round: 150/111/87 Flat: 107/79/62
	CSA Class 3** 25mm ice (350/450/550 Pa)	Round: 63/46/35 Flat: 42/31/23	Round: 75/54/41 Flat: 50/36/27	Round: 85/62/48 Flat: 57/41/32	Round: 145/111/88 Flat: 97/74/59	Round: 250/192/150 Flat: 167/128/100
Knocked-down Towers	L"xW"xH"	133x48x15	133x48x15	133x48x15	133x48x16	133x48x16
Assembled Towers	L"xW"xH"	133x48x27	133x60x31	133x60x34	133x75x37	133x75x40
Shipping Weight (lbs)		856	875	908	1,018	1,139

\*Assumptions: Projected areas (PA) shown are bare; a 1.5 multiplier used for iced area; loads centrally located and balanced at tower top; considers step-pegs, safety cable, and one 1/2" tx line per 10 sq.ft.; "-" indicates tower failure.  
\*\* For examples of CSA Class 1 vs Class 3, see page 28.

## Common Accessories

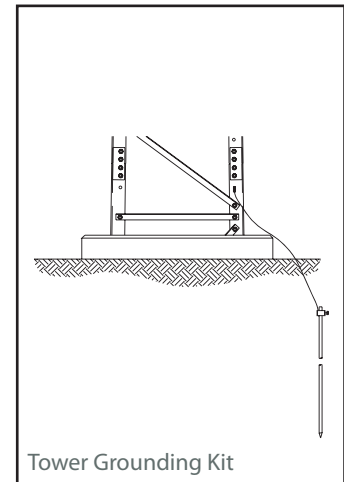

Accessory:	S100	S200	S300	S400	S500
<b>Cable Safety Climb Kits</b> no slider	4.99.0485.050	4.99.0485.050	4.99.0485.050	4.99.0485.050	4.99.0485.050
<b>Step-Bolt Kit</b> leg mounted	4.98.0100.030	4.98.0100.030	4.98.0100.030	4.98.0100.030	4.98.0100.030
<b>Anti-Climb Shield Kits</b>	4.92.0001.003	4.92.0001.004	4.92.0001.005	4.92.0001.006	4.92.0001.007
<b>Tower Grounding Kit</b> basic, single leg	4.91.0103.000	4.91.0103.000	4.91.0103.000	4.91.0103.000	4.91.0103.000

For more SuperTITAN Accessories and Replacement Parts, see pages 61 to 76.



# 40' Towers



Model Designation:		S100	S200	S300	S400	S500		
Knocked-down Part Number:		5.94.0100.040	5.94.0200.040	5.94.0300.040	5.94.0400.040	5.94.0500.040		
Assembled Part Number:		5.95.0100.040	5.95.0200.040	5.95.0300.040	5.95.0400.040	5.95.0500.040		
Includes 5' embedment section for concrete foundation, splice hardware, and pipe anchor brackets for antenna mounting pipe (pipe sold separately on page 70).  Knocked-down towers reduce shipping cost in comparison with pre-assembled.								
Allowable antenna area in ft <sup>2</sup> at**	CSA Class 1** 10mm ice (350/450/550 Pa)	Round: 27/16/10 Flat: 19/11/7	Round: 32/20/12 Flat: 22/14/8	Round: 54/39/29 Flat: 38/27/20	Round: 106/80/63 Flat: 75/57/45	Round: 128/92/68 Flat: 91/65/48		
	CSA Class 1** 25mm ice (350/450/550 Pa)	Round: 23/14/9 Flat: 16/10/6	Round: 30/20/10 Flat: 21/14/7	Round: 53/39/29 Flat: 37/27/20	Round: 105/80/61 Flat: 75/57/43	Round: 120/87/67 Flat: 85/62/47		
	CSA Class 3** 25mm ice (350/450/550 Pa)	Round: 42/28/20 Flat: 28/19/13	Round: 50/34/23 Flat: 33/23/15	Round: 79/58/44 Flat: 53/39/29	Round: 138/104/83 Flat: 92/69/55	Round: 180/133/104 Flat: 120/89/69		
Knocked-down Towers	L"xW"xH"	133x48x24	133x48x24	133x48x24	133x48x24	133x48x24		
Assembled Towers	L"xW"xH"	133x60x31	133x60x34	133x60x37	133x75x40	133x75x43		
Shipping Weight (lbs)		1,078	1,111	1,241	1,351	1,467		

\*Assumptions: Projected areas (PA) shown are bare; a 1.5 multiplier used for iced area; loads centrally located and balanced at tower top; considers step-pegs, safety cable, and one 1/2" tx line per 10 sq.ft.; "-" indicates tower failure.  
\*\* For examples of CSA Class 1 vs Class 3, see page 28.

## Common Accessories

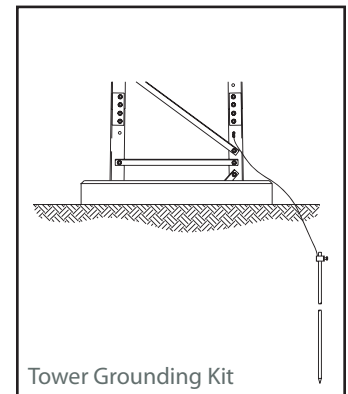

Accessory:	S100	S200	S300	S400	S500		
<b>Cable Safety Climb Kits</b> no slider	4.99.0485.050	4.99.0485.050	4.99.0485.050	4.99.0485.050	4.99.0485.050		
<b>Step-Bolt Kit</b> leg mounted	4.98.0100.040	4.98.0100.040	4.98.0100.040	4.98.0100.040	4.98.0100.040		
<b>Anti-Climb Shield Kits</b>	4.92.0001.004	4.92.0001.005	4.92.0001.006	4.92.0001.007	4.92.0001.008		
<b>Tower Grounding Kit</b> basic, single leg	4.91.0103.000	4.91.0103.000	4.91.0103.000	4.91.0103.000	4.91.0103.000		

For more SuperTITAN Accessories and Replacement Parts, see pages 61 to 76.



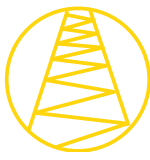

Model Designation:		S100	S200	S300	S400	S500	S600	H800
Knocked-down Part Number:		5.94.0100.050	5.94.0200.050	5.94.0300.050	5.94.0400.050	5.94.0500.050	5.94.0600.050	5.94.H800.050
Assembled Part Number:		5.95.0100.050	5.95.0200.050	5.95.0300.050	5.95.0400.050	5.95.0500.050	5.95.0600.050	5.95.H800.050
Includes anchor material for concrete foundation, splice hardware, and pipe anchor brackets for antenna mounting pipe (pipe sold separately on page 70).  Models S100 to H800 use a 5' embedment section as the anchor for concrete.  Knocked-down towers reduce shipping cost in comparison with pre-assembled.								
Allowable antenna area in ft² at*	CSA Class 1** 10mm ice (350/450/550 Pa)	Round: 14/5/- Flat: 10/3/-	Round: 30/19/10 Flat: 21/13/7	Round: 50/36/27 Flat: 35/25/19	Round: 84/58/42 Flat: 60/41/30	Round: 90/62/44 Flat: 64/44/31	Round: 92/60/40 Flat: 65/42/28	Round: 90/64/47 Flat: 64/45/33
	CSA Class 1** 25mm ice (350/450/550 Pa)	Round: 10/5/- Flat: 7/3/-	Round: 29/19/10 Flat: 21/13/7	Round: 50/35/27 Flat: 35/25/19	Round: 73/52/39 Flat: 52/37/27	Round: 80/60/40 Flat: 57/42/28	Round: 83/60/40 Flat: 59/42/28	Round: 90/64/47 Flat: 64/45/33
	CSA Class 3** 25mm ice (350/450/550 Pa)	Round: 27/16/8 Flat: 18/11/5	Round: 48/30/21 Flat: 31/20/14	Round: 76/54/41 Flat: 51/36/27	Round: 124/89/66 Flat: 83/59/44	Round: 134/97/72 Flat: 89/65/48	Round: 144/103/78 Flat: 96/69/52	Round: 196/138/98 Flat: 130/92/65
Knocked-down Towers	L"xW"xH"	133x48x24	133x48x24	133x48x24	133x48x25	133x48x25	133x48x25	122x48x26
Assembled Towers	L"xW"xH"	133x60x34	133x60x37	133x75x40	133x75x43	133x75x46	133x75x49	133x91x52
Shipping Weight (lbs)		1,314	1,430	1,560	1,679	1,798	1,932	2,479

\*Assumptions: Projected areas (PA) shown are bare; a 1.5 multiplier used for iced area; loads centrally located and balanced at tower top; considers step-pegs, safety cable, and one 1/2" tx line per 10 sq.ft. "-" indicates tower failure.  
\*\* For examples of CSA Class 1 vs Class 3, see page 28.

## Common Accessories

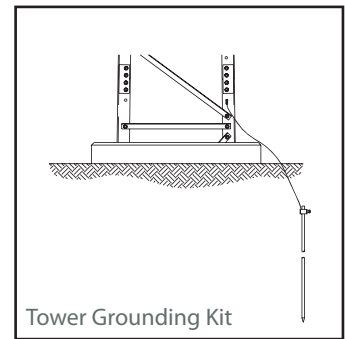
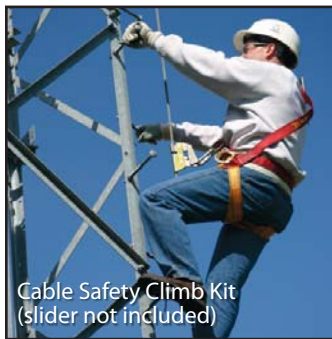

Accessory:	S100	S200	S300	S400	S500	S600	H800
<b>Cable Safety Climb Kits</b> no slider	4.99.0485.050	4.99.0485.050	4.99.0485.050	4.99.0485.050	4.99.0485.050	4.99.0485.050	4.99.0485.050
<b>Step-Bolt Kit</b> leg mounted	4.98.0100.050	4.98.0100.050	4.98.0100.050	4.98.0100.050	4.98.0100.050	4.98.0100.050	4.98.0100.050
<b>Anti-Climb Shield Kits</b>	4.92.0001.005	4.92.0001.006	4.92.0001.007	4.92.0001.008	4.92.0001.009	4.92.0001.010	4.92.0001.012
<b>Tower Grounding Kit</b> basic, single leg	4.91.0103.000	4.91.0103.000	4.91.0103.000	4.91.0103.000	4.91.0103.000	4.91.0103.000	4.91.0103.000

For more SuperTITAN Accessories and Replacement Parts, see pages 61 to 76.

Model Designation:		H810	S1000	S1010	S1100	S1200
Knocked-down Part Number:		5.94.H810.050	5.94.1000.050	5.94.1010.050	5.94.1100.050	5.94.1200.050
Assembled Part Number:		5.95.H810.050	N/A	N/A	N/A	N/A
Includes anchor material for concrete foundation, splice hardware, and pipe anchor brackets for antenna mounting pipe (pipe sold separately on page 70).  Model H810 uses a 5' embedment section as the anchor for concrete; models S1000 to S1200 use base feet and tie-rods for concrete foundation.  Knocked-down towers reduce shipping cost in comparison with pre-assembled.						
Allowable antenna area in ft <sup>2</sup> at*	CSA Class 1** 10mm ice (350/450/550 Pa)	Round: 170/124/96 Flat: 113/83/64	Round: 204/149/115 Flat: 136/99/77	Round: 204/149/115 Flat: 136/99/77	Round: 224/164/127 Flat: 149/109/84	Round: 246/180/139 Flat: 164/120/93
	CSA Class 1** 25mm ice (350/450/550 Pa)	Round: 170/124/94 Flat: 113/83/63	Round: 204/149/113 Flat: 136/99/75	Round: 204/149/113 Flat: 136/99/75	Round: 224/164/127 Flat: 149/109/84	Round: 246/180/139 Flat: 164/120/93
	CSA Class 3** 25mm ice (350/450/550 Pa)	Round: 220/162/128 Flat: 147/108/85	Round: 264/194/153 Flat: 176/129/102	Round: 264/194/153 Flat: 176/129/102	Round: 290/213/168 Flat: 193/142/112	Round: 319/234/184 Flat: 212/156/122
Knocked-down Towers	L"xW"xH"	122x48x26	133x48x48	133x48x48	133x48x48	133x48x48
Assembled Towers	L"xW"xH"	133x91x52	N/A	N/A	N/A	N/A
Shipping Weight (lbs)		2,526	4,024	4,024	4,359	4,668

\*Assumptions: Projected areas (PA) shown are bare; a 1.5 multiplier used for iced area; loads centrally located and balanced at tower top; considers step-pegs, safety cable, and one 1/2" tx line per 10 sq.ft.; "-" indicates tower failure.  
\*\* For examples of CSA Class 1 vs Class 3, see page 28.

## Common Accessories

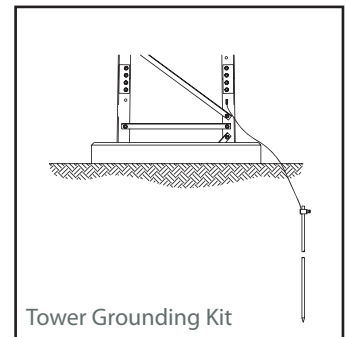

Accessory:	H810	S1000	S1010	S1100	S1200
<b>Cable Safety Climb Kits</b> no slider	4.99.0485.050	4.99.0485.050	4.99.0485.050	4.99.0485.050	4.99.0485.050
<b>Step-Bolt Kit</b> leg mounted	4.98.0100.050	4.98.1000.050	4.98.1000.050	4.98.1100.050	4.98.1200.050
<b>Anti-Climb Shield Kits</b>	4.92.0001.012	4.92.0001.213	4.92.0001.213	4.92.0001.213	4.92.0001.213
<b>Tower Grounding Kit</b> basic, single leg	4.91.0103.000	4.91.0103.003	4.91.0103.003	4.91.0103.003	4.91.0103.003

For more SuperTITAN Accessories and Replacement Parts, see pages 61 to 76.

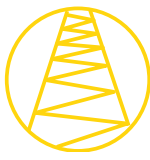

Model Designation:		S100	S200	S300	S400	S500	S600	H700
Knocked-down Part Number:		5.94.0100.060	5.94.0200.060	5.94.0300.060	5.94.0400.060	5.94.0500.060	5.94.0600.060	5.94.H700.060
Assembled Part Number:		5.95.0100.060	5.95.0200.060	5.95.0300.060	5.95.0400.060	5.95.0500.060	5.95.0600.060	5.95.H700.060
Includes anchor material for concrete foundation, splice hardware, and pipe anchor brackets for antenna mounting pipe (pipe sold separately on page 70). Models S100 to H700 use a 5' embedment section as the anchor for concrete. Knocked-down towers reduce shipping cost in comparison with pre-assembled.								
Allowable antenna area in ft <sup>2</sup> at*	CSA Class 1** 10mm ice (350/450/550 Pa)	Round: 12/3/-- Flat: 8/2/--	Round: 27/17/10 Flat: 19/12/7	Round: 49/34/20 Flat: 35/24/14	Round: 60/38/25 Flat: 42/27/17	Round: 66/40/27 Flat: 47/28/19	Round: 76/49/30 Flat: 54/35/21	Round: 80/55/35 Flat: 57/38/25
	CSA Class 1** 25mm ice (350/450/550 Pa)	Round: 10/3/-- Flat: 7/2/--	Round: 25/17/10 Flat: 17/12/7	Round: 49/31/20 Flat: 35/22/14	Round: 51/38/25 Flat: 36/27/17	Round: 60/40/27 Flat: 42/28/19	Round: 67/47/30 Flat: 47/33/21	Round: 80/55/35 Flat: 57/39/25
	CSA Class 3** 25mm ice (350/450/550 Pa)	Round: 25/14/6 Flat: 17/9/4	Round: 42/28/19 Flat: 28/19/13	Round: 72/51/39 Flat: 48/34/26	Round: 94/65/46 Flat: 63/43/31	Round: 101/68/48 Flat: 67/45/32	Round: 116/79/57 Flat: 77/53/38	Round: 186/128/90 Flat: 124/85/60
Knocked-down Towers	L"xW"xH"	133x48x24	133x48x25	133x48x25	133x48x25	133x48x25	133x48x26	133x48x30
Assembled Towers	L"xW"xH"	133x60x37	133x75x40	133x75x43	133x75x46	133x75x49	133x87x52	133x90x52
Shipping Weight (lbs)		1,633	1,763	1,888	2,010	2,147	2,360	2,784

\*Assumptions: Projected areas (PA) shown are bare; a 1.5 multiplier used for iced area; loads centrally located and balanced at tower top; considers step-pegs, safety cable, and one 1/2" tx line per 10 sq.ft.; "--" indicates tower failure.  
\*\* For examples of CSA Class 1 vs Class 3, see page 28.

## Common Accessories

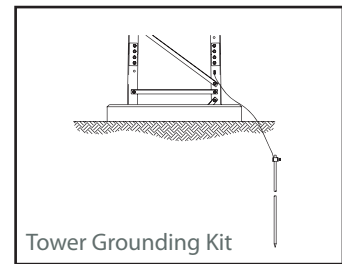

Accessory:	S100	S200	S300	S400	S500	S600	H700
<b>Cable Safety Climb Kits</b> no slider	4.99.0485.100	4.99.0485.100	4.99.0485.100	4.99.0485.100	4.99.0485.100	4.99.0485.100	4.99.0485.100
<b>Step-Bolt Kit</b> leg mounted	4.98.0100.060	4.98.0100.060	4.98.0100.060	4.98.0100.060	4.98.0100.060	4.98.0100.060	4.98.0100.060
<b>Anti-Climb Shield Kits</b>	4.92.0001.006	4.92.0001.007	4.92.0001.008	4.92.0001.009	4.92.0001.010	4.92.0001.011	4.92.0001.012
<b>Tower Grounding Kit</b> basic, single leg	4.91.0103.000	4.91.0103.000	4.91.0103.000	4.91.0103.000	4.91.0103.000	4.91.0103.000	4.91.0103.000

For more SuperTITAN Accessories and Replacement Parts, see pages 61 to 76.

Model Designation:		H710	S900	S910	S1000	S1010	S1100
Knocked-down Part Number:		5.94.H710.060	5.94.0900.060	5.94.0910.060	5.94.1000.060	5.94.1010.060	5.94.1100.060
Assembled Part Number:		5.95.H710.060	N/A	N/A	N/A	N/A	N/A
<p>Includes anchor material for concrete foundation, splice hardware, and pipe anchor brackets for antenna mounting pipe (pipe sold separately on page 70).</p> <p>Model H710 uses a 5' embedment section as the anchor for concrete; models S900 to S1100 use base feet and tie-rods for concrete foundation.</p> <p>Knocked-down towers reduce shipping cost in comparison with pre-assembled.</p>							
Allowable antenna area in ft² at*	CSA Class 1** 10mm ice (350/450/550 Pa)	Round: 152/110/80 Flat: 101/73/53	Round: 167/121/88 Flat: 111/80/58	Round: 170/124/96 Flat: 113/83/64	Round: 187/136/106 Flat: 125/90/70	Round: 296/210/164 Flat: 197/140/109	Round: 325/231/180 Flat: 216/154/119
	CSA Class 1** 25mm ice (350/450/550 Pa)	Round: 152/106/76 Flat: 101/71/51	Round: 167/116/83 Flat: 111/77/55	Round: 170/124/94 Flat: 113/83/63	Round: 187/136/103 Flat: 125/90/77	Round: 296/210/164 Flat: 197/140/109	Round: 325/231/180 Flat: 216/154/119
	CSA Class 3** 25mm ice (350/450/550 Pa)	Round: 206/146/112 Flat: 137/97/75	Round: 210/160/126 Flat: 140/106/84	Round: 210/160/126 Flat: 140/106/84	Round: 231/176/138 Flat: 154/117/92	Round: 370/280/220 Flat: 247/187/147	Round: 407/308/242 Flat: 271/205/161
Knocked-down Towers	L"xW"xH"	133x48x30	133x48x48	133x48x48	133x48x48	133x48x48	133x48x48
Assembled Towers	L"xW"xH"	133x90x52	N/A	N/A	N/A	N/A	N/A
Shipping Weight (lbs)		2,831	4,343	4,390	4,790	4,837	5,142

\*Assumptions: Projected areas (PA) shown are bare; a 1.5 multiplier used for iced area; loads centrally located and balanced at tower top; considers step-pegs, safety cable, and one 1/2" tx line per 10 sq.ft.; "-" indicates tower failure.  
 \*\* For examples of CSA Class 1 vs Class 3, see page 28.

## Common Accessories

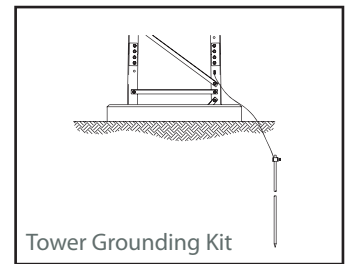

Accessory:	H710	S900	S910	S1000	S1010	S1100
<b>Cable Safety Climb Kits</b> no slider	4.99.0485.100	4.99.0485.100	4.99.0485.100	4.99.0485.100	4.99.0485.100	4.99.0485.100
<b>Step-Bolt Kit</b> leg mounted	4.98.0100.060	4.98.S900.060	4.98.S900.060	4.98.1000.060	4.98.1000.060	4.98.1100.060
<b>Anti-Climb Shield Kits</b>	4.92.0001.012	4.92.0001.213	4.92.0001.213	4.92.0001.213	4.92.0001.213	4.92.0001.213
<b>Tower Grounding Kit</b> basic, single leg	4.91.0103.000	4.91.0103.003	4.91.0103.003	4.91.0103.003	4.91.0103.003	4.91.0103.003

For more SuperTITAN Accessories and Replacement Parts, see pages 61 to 76.

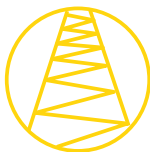

Model Designation:		S100	S200	S300	S400	S500	S600	H600
Knocked-down Part Number:		5.94.0100.070	5.94.0200.070	5.94.0300.070	5.94.0400.070	5.94.0500.070	5.94.0600.070	5.94.H600.070
Assembled Part Number:		5.95.0100.070	5.95.0200.070	5.95.0300.070	5.95.0400.070	5.95.0500.070	5.95.0600.070	5.95.H600.070
Includes anchor material for concrete foundation, splice hardware, and pipe anchor brackets for antenna mounting pipe (pipe sold separately on page 70). Models S100 to H600 use a 5' embedment section as the anchor for concrete. Knocked-down towers reduce shipping cost in comparison with pre-assembled.								
Allowable antenna area in ft² at*	CSA Class 1** 10mm ice (350/450/550 Pa)	Round: 10/1/-- Flat: 7/--/--	Round: 25/15/8 Flat: 17/10/5	Round: 39/20/10 Flat: 27/14/7	Round: 40/22/10 Flat: 28/15/7	Round: 49/28/12 Flat: 35/20/8	Round: 50/29/12 Flat: 35/20/8	Round: 80/50/30 Flat: 57/35/21
	CSA Class 1** 25mm ice (350/450/550 Pa)	Round: 10/1/-- Flat: 7/--/--	Round: 25/15/7 Flat: 17/10/5	Round: 33/20/10 Flat: 23/14/7	Round: 40/22/10 Flat: 28/15/7	Round: 49/28/12 Flat: 35/20/8	Round: 49/29/12 Flat: 35/20/8	Round: 75/50/30 Flat: 53/35/21
	CSA Class 3** 25mm ice (350/450/550 Pa)	Round: 23/12/5 Flat: 15/8/3	Round: 41/26/18 Flat: 27/17/12	Round: 68/42/26 Flat: 45/28/17	Round: 72/45/28 Flat: 48/30/19	Round: 82/53/34 Flat: 55/35/23	Round: 88/56/36 Flat: 59/37/24	Round: 132/92/69 Flat: 88/61/46
Knocked-down Towers	L"xW"xH"	133x48x25	133x48x25	133x48x25	133x48x25	133x48x26	133x48x27	133x48x30
Assembled Towers	L"xW"xH"	133x75x40	133x75x43	133x75x46	133x75x49	133x75x52	133x84x52	133x84x52
Shipping Weight (lbs)		1,966	2,091	2,219	2,359	2,575	2,752	3,063

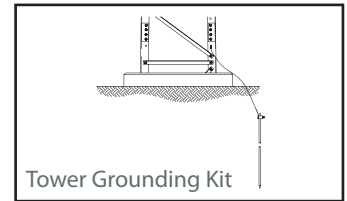

\*Assumptions: Projected areas (PA) shown are bare; a 1.5 multiplier used for iced area; loads centrally located and balanced at tower top; considers step-pegs, safety cable, and one 1/2" tx line per 10 sq.ft.; "--" indicates tower failure. \*\* For examples of CSA Class 1 vs Class 3, see page 28.

## Common Accessories

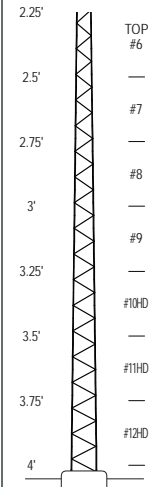
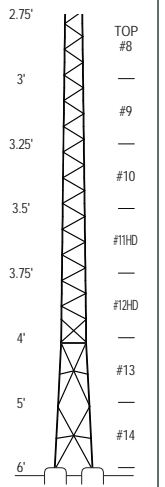
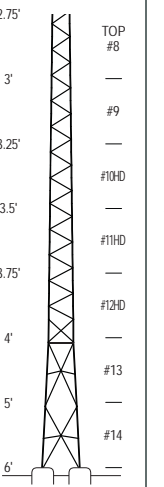
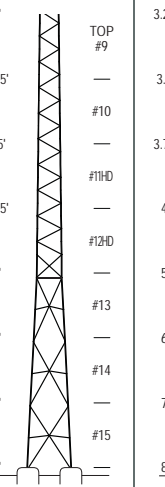
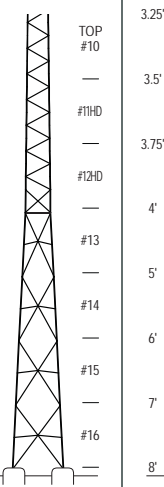
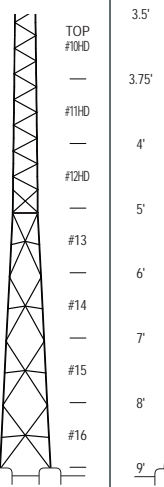

Accessory:	S100	S200	S300	S400	S500	S600	H600
<b>Cable Safety Climb Kits</b> no slider	4.99.0485.100	4.99.0485.100	4.99.0485.100	4.99.0485.100	4.99.0485.100	4.99.0485.100	4.99.0485.100
<b>Step-Bolt Kit</b> leg mounted	4.98.0100.070	4.98.0100.070	4.98.0100.070	4.98.0100.070	4.98.0100.070	4.98.0100.070	4.98.0100.070
<b>Anti-Climb Shield Kits</b>	4.92.0001.007	4.92.0001.008	4.92.0001.009	4.92.0001.010	4.92.0001.011	4.92.0001.012	4.92.0001.012
<b>Tower Grounding Kit</b> basic, single leg	4.91.0103.000	4.91.0103.000	4.91.0103.000	4.91.0103.000	4.91.0103.000	4.91.0103.000	4.91.0103.000

For more SuperTITAN Accessories and Replacement Parts, see pages 61 to 76.

Model Designation:		H610	S800	S810	S900	S1000	S1010	S1100
Knocked-down Part Number:		5.94.H610.070	5.94.0800.070	5.94.0810.070	5.94.0900.070	5.94.1000.070	5.94.1010.070	5.94.1100.070
Assembled Part Number:		N/A	N/A	N/A	N/A	N/A	N/A	N/A
Includes anchor material for concrete foundation, splice hardware, and pipe anchor brackets for antenna mounting pipe (pipe sold separately on page 70).  Model H610 uses a 5' embedment section as the anchor for concrete; models S800 to S1100 use base feet and tie-rods for concrete foundation.  Knocked-down towers reduce shipping cost in comparison with pre-assembled.								
Allowable antenna area in ft <sup>2</sup> at*	CSA Class 1** 10mm ice (350/450/550 Pa)	Round: 116/78/54 Flat: 77/52/36	Round: 133/90/62 Flat: 88/60/41	Round: 146/110/86 Flat: 97/73/57	Round: 160/121/94 Flat: 106/80/62	Round: 176/133/103 Flat: 117/88/68	Round: 254/180/132 Flat: 169/120/88	Round: 279/198/145 Flat: 186/132/96
	CSA Class 1** 25mm ice (350/450/550 Pa)	Round: 116/78/54 Flat: 77/52/36	Round: 133/90/62 Flat: 88/60/41	Round: 146/110/84 Flat: 97/73/56	Round: 160/121/92 Flat: 106/80/61	Round: 176/133/101 Flat: 117/88/67	Round: 254/180/130 Flat: 169/120/87	Round: 279/198/143 Flat: 186/132/95
	CSA Class 3** 25mm ice (350/450/550 Pa)	Round: 160/112/81 Flat: 107/75/54	Round: 184/128/93 Flat: 122/85/62	Round: 198/150/110 Flat: 132/100/73	Round: 217/165/121 Flat: 144/110/80	Round: 238/181/133 Flat: 158/120/88	Round: 332/244/182 Flat: 221/163/121	Round: 365/268/200 Flat: 243/178/133
Knocked-down Towers	L"xW"xH"	133x48x30	133x48x48	133x48x48	133x48x48	133x48x48	133x48x48	133x48x48
Assembled Towers	L"xW"xH"	N/A	N/A	N/A	N/A	N/A	N/A	N/A
Shipping Weight (lbs)		3,110	4,658	4,705	5,109	5,573	5,620	5,990

\*Assumptions: Projected areas (PA) shown are bare; a 1.5 multiplier used for iced area; loads centrally located and balanced at tower top; considers step-pegs, safety cable, and one 1/2" tx line per 10 sq.ft.; "-" indicates tower failure.  
\*\* For examples of CSA Class 1 vs Class 3, see page 28.

## Common Accessories

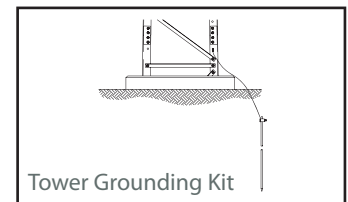
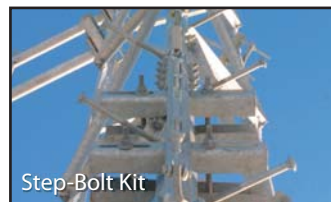
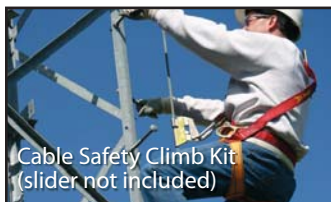

Accessory:	H610	S800	S810	S900	S1000	S1010	S1100
<b>Cable Safety Climb Kits</b> no slider	4.99.0485.100	4.99.0485.100	4.99.0485.100	4.99.0485.100	4.99.0485.100	4.99.0485.100	4.99.0485.100
<b>Step-Bolt Kit</b> leg mounted	4.98.0100.070	4.98.S800.070	4.98.S800.070	4.98.S900.070	4.98.1000.070	4.98.1000.070	4.98.1100.070
<b>Anti-Climb Shield Kits</b>	4.92.0001.012	4.92.0001.213	4.92.0001.213	4.92.0001.213	4.92.0001.213	4.92.0001.213	4.92.0001.213
<b>Tower Grounding Kit</b> basic, single leg	4.91.0103.000	4.91.0103.003	4.91.0103.003	4.91.0103.003	4.91.0103.003	4.91.0103.003	4.91.0103.003

For more SuperTITAN Accessories and Replacement Parts, see pages 61 to 76.

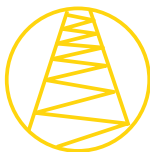

Model Designation:		S100	S200	S300	S400	S500	H500	H510							
Knocked-down Part Number:		5.94.0100.080	5.94.0200.080	5.94.0300.080	5.94.0400.080	5.94.0500.080	5.94.H500.080	5.94.H510.080							
Assembled Part Number:		5.95.0100.080	5.95.0200.080	5.95.0300.080	5.95.0400.080	5.95.0500.080	5.95.H500.080	5.95.H510.080							
Includes anchor material for concrete foundation, splice hardware, and pipe anchor brackets for antenna mounting pipe (pipe sold separately on page 70). Models S100 to S510 use a 5' embedment section as the anchor for concrete. Knocked-down towers reduce shipping cost in comparison with pre-assembled.															
Allowable antenna area in ft² at*	CSA Class 1** 10mm ice (350/450/550 Pa)	Round: 10/1/-- Flat: 7/--/--	Round: 22/9/-- Flat: 15/6/--	Round: 25/9/-- Flat: 17/6/--	Round: 30/12/-- Flat: 21/8/--	Round: 30/12/-- Flat: 21/8/--	Round: 60/37/20 Flat: 42/26/14	Round: 84/54/32 Flat: 56/36/21							
	CSA Class 1** 25mm ice (350/450/550 Pa)	Round: 10/--/-- Flat: 7/--/--	Round: 20/8/-- Flat: 14/5/--	Round: 21/9/-- Flat: 15/6/--	Round: 30/12/-- Flat: 21/8/--	Round: 30/12/-- Flat: 21/8/--	Round: 53/37/20 Flat: 37/26/14	Round: 84/54/30 Flat: 56/36/20							
	CSA Class 3** 25mm ice (350/450/550 Pa)	Round: 21/11/3 Flat: 14/7/2	Round: 40/25/12 Flat: 27/17/8	Round: 50/27/13 Flat: 33/18/9	Round: 60/34/17 Flat: 40/23/11	Round: 61/35/17 Flat: 41/23/11	Round: 93/62/43 Flat: 62/41/28	Round: 116/82/56 Flat: 77/55/37							
Knocked-down Towers	L"xW"xH"	133x48x33	133x48x34	133x48x34	133x48x34	133x48x35	133x48x35	133x48x35							
Assembled Towers	L"xW"xH"	133x75x43	133x75x46	133x75x49	133x75x52	133x86x55	133x86x55	133x86x55							
Shipping Weight (lbs)		2,294	2,422	2,568	2,787	2,967	3,278	3,325							

\*Assumptions: Projected areas (PA) shown are bare; a 1.5 multiplier used for iced area; loads centrally located and balanced at tower top; considers step-pegs, safety cable, and one 1/2" tx line per 10 sq.ft.; "--" indicates tower failure.  
\*\* For examples of CSA Class 1 vs Class 3, see page 28.

## Common Accessories

Accessory:	S100	S200	S300	S400	S500	H500	H510
<b>Cable Safety Climb Kits</b> no slider	4.99.0485.100	4.99.0485.100	4.99.0485.100	4.99.0485.100	4.99.0485.100	4.99.0485.100	4.99.0485.100
<b>Step-Bolt Kit</b> leg mounted	4.98.0100.080	4.98.0100.080	4.98.0100.080	4.98.0100.080	4.98.0100.080	4.98.0100.080	4.98.0100.080
<b>Anti-Climb Shield Kits</b>	4.92.0001.008	4.92.0001.009	4.92.0001.010	4.92.0001.011	4.92.0001.012	4.92.0001.012	4.92.0001.012
<b>Tower Grounding Kit</b> basic, single leg	4.91.0103.000	4.91.0103.000	4.91.0103.000	4.91.0103.000	4.91.0103.000	4.91.0103.000	4.91.0103.000

For more SuperTITAN Accessories and Replacement Parts, see pages 61 to 76.



# 80' Towers continued



Model Designation:		S700	S710	S800	S810	S910	S1010	S1100
Knocked-down Part Number:		5.94.0700.080	5.94.0710.080	5.94.0800.080	5.94.0810.080	5.94.0910.080	5.94.1010.080	5.94.1100.080
Assembled Part Number:		N/A	N/A	N/A	N/A	N/A	N/A	N/A
<p>Includes anchor material for concrete foundation, splice hardware, and pipe anchor brackets for antenna mounting pipe (pipe sold separately on page 70).</p> <p>Models H700 to S710 use a 5' embedment section as the anchor for concrete; models S800 to S1100 use base feet and tie-rods for concrete foundation.</p> <p>Knocked-down towers reduce shipping cost in comparison with pre-assembled.</p>								
Allowable antenna area in ft <sup>2</sup> at*	CSA Class 1** 10mm ice (350/450/550 Pa)	Round: 100/64/38 Flat: 66/42/25	Round: 128/84/54 Flat: 85/56/36	Round: 140/92/59 Flat: 93/61/39	Round: 152/108/78 Flat: 101/72/52	Round: 166/118/85 Flat: 110/79/57	Round: 199/141/93 Flat: 132/94/62	Round: 238/169/111 Flat: 158/112/74
	CSA Class 1** 25mm ice (350/450/550 Pa)	Round: 100/64/36 Flat: 66/42/24	Round: 128/84/54 Flat: 85/56/36	Round: 140/92/59 Flat: 93/61/39	Round: 152/108/78 Flat: 101/72/52	Round: 166/118/85 Flat: 110/79/57	Round: 199/141/93 Flat: 132/94/62	Round: 238/169/111 Flat: 158/112/74
	CSA Class 3** 25mm ice (350/450/550 Pa)	Round: 172/116/80 Flat: 115/77/53	Round: 174/122/86 Flat: 116/81/57	Round: 190/134/57 Flat: 126/89/38	Round: 200/140/112 Flat: 133/92/75	Round: 220/156/123 Flat: 146/104/82	Round: 264/187/147 Flat: 176/124/139	Round: 316/224/177 Flat: 210/149/118
Knocked-down Towers	L"xW"xH"	133x48x48	133x48x48	133x48x50	133x48x50	133x48x50	133x48x54	133x96x40
Assembled Towers	L"xW"xH"	N/A	N/A	N/A	N/A	N/A	N/A	N/A
Shipping Weight (lbs)		4,963	5,010	5,424	5,471	5,892	6,421	7,038

\*Assumptions: Projected areas (PA) shown are bare; a 1.5 multiplier used for iced area; loads centrally located and balanced at tower top; considers step-pegs, safety cable, and one 1/2" tx line per 10 sq.ft.; "--" indicates tower failure.  
\*\* For examples of CSA Class 1 vs Class 3, see page 28.

## Common Accessories

Accessory:	S700	S710	S800	S810	S910	S1010	S1100
<b>Cable Safety Climb Kits</b> no slider	4.99.0485.100	4.99.0485.100	4.99.0485.100	4.99.0485.100	4.99.0485.100	4.99.0485.100	4.99.0485.100
<b>Step-Bolt Kit</b> leg mounted	4.98.S700.080	4.98.S700.080	4.98.S800.080	4.98.S800.080	4.98.S900.080	4.98.1000.080	4.98.1100.080
<b>Anti-Climb Shield Kits</b>	4.92.0001.213	4.92.0001.213	4.92.0001.213	4.92.0001.213	4.92.0001.213	4.92.0001.213	4.92.0001.213
<b>Tower Grounding Kit</b> basic, single leg	4.91.0103.003	4.91.0103.003	4.91.0103.003	4.91.0103.003	4.91.0103.003	4.91.0103.003	4.91.0103.003

For more SuperTITAN Accessories and Replacement Parts, see pages 61 to 76.

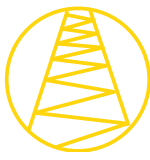

Model Designation:		S100	S200	S300	S400	H400	H410	S600
Knocked-down Part Number:		5.94.0100.090	5.94.0200.090	5.94.0300.090	5.94.0400.090	5.94.H400.090	5.94.H410.090	5.94.0600.090
Assembled Part Number:		5.95.0100.090	5.95.0200.090	5.95.0300.090	5.95.0400.090	5.95.H400.090	5.95.H410.090	N/A
Includes anchor material for concrete foundation, splice hardware, and pipe anchor brackets for antenna mounting pipe (pipe sold separately on page 70).  Models S100 to H410 use a 5' embedment section as the anchor for concrete; model S600 uses base feet and tie-rods.  Knocked-down towers reduce shipping cost in comparison with pre-assembled.								
Allowable antenna area in ft² at*	CSA Class 1** 10mm ice (350/450/550 Pa)	Round: 9/-- Flat: 6/--	Round: 10/-- Flat: 7/--	Round: 15/-- Flat: 10/--	Round: 15/-- Flat: 10/--	Round: 38/18/7 Flat: 27/13/5	Round: 58/34/16 Flat: 39/23/11	Round: 77/45/22 Flat: 51/30/15
	CSA Class 1** 25mm ice (350/450/550 Pa)	Round: 9/-- Flat: 6/--	Round: 10/-- Flat: 7/--	Round: 14/-- Flat: 10/--	Round: 15/-- Flat: 10/--	Round: 35/19/7 Flat: 25/13/5	Round: 58/34/14 Flat: 39/23/9	Round: 77/45/19 Flat: 51/30/12
	CSA Class 3** 25mm ice (350/450/550 Pa)	Round: 20/10/-- Flat: 13/7/--	Round: 32/14/-- Flat: 21/9/--	Round: 39/18/3 Flat: 26/12/2	Round: 41/19/3 Flat: 27/13/2	Round: 65/40/24 Flat: 43/26/16	Round: 82/54/36 Flat: 55/36/24	Round: 126/89/60 Flat: 84/59/40
Knocked-down Towers	L"xW"xH"	133x48x34	133x48x34	133x48x35	133x48x35	133x96x44	133x96x44	133x48x58
Assembled Towers	L"xW"xH"	133x75x46	133x75x49	133x75x52	133x75x55	133x75x55	133x75x55	N/A
Shipping Weight (lbs)		2,625	2,771	2,996	3,179	3,565	3,226	5,242

\*Assumptions: Projected areas (PA) shown are bare; a 1.5 multiplier used for iced area; loads centrally located and balanced at tower top; considers step-pegs, safety cable, and one 1/2" tx line per 10 sq.ft.; "--" indicates tower failure.  
\*\* For examples of CSA Class 1 vs Class 3, see page 28.

## Common Accessories

Accessory:	S100	S200	S300	S400	H400	H410	S600
<b>Cable Safety Climb Kits</b> no slider	4.99.0485.100	4.99.0485.100	4.99.0485.100	4.99.0485.100	4.99.0485.100	4.99.0485.100	4.99.0485.100
<b>Step-Bolt Kit</b> leg mounted	4.98.0100.090	4.98.0100.090	4.98.0100.090	4.98.0100.090	4.98.0100.090	4.98.0100.090	4.98.S600.090
<b>Anti-Climb Shield Kits</b>	4.92.0001.009	4.92.0001.010	4.92.0001.011	4.92.0001.012	4.92.0001.012	4.92.0001.012	4.92.0001.213
<b>Tower Grounding Kit</b> basic, single leg	4.91.0103.000	4.91.0103.000	4.91.0103.000	4.91.0103.000	4.91.0103.000	4.91.0103.000	4.91.0103.003

For more SuperTITAN Accessories and Replacement Parts, see pages 61 to 76.

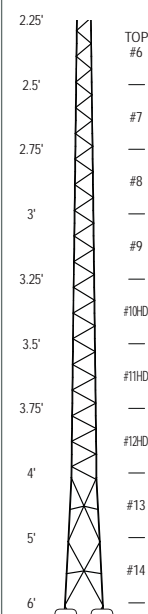
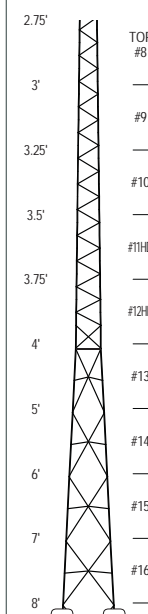
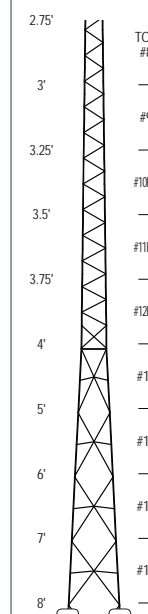
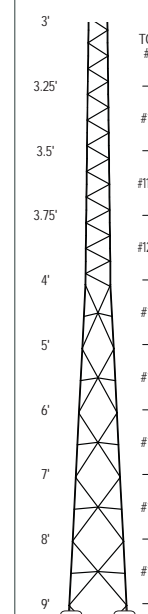
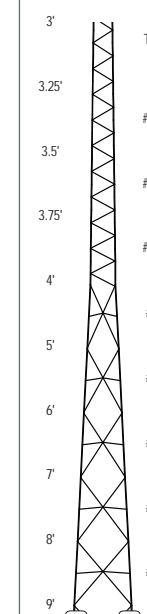
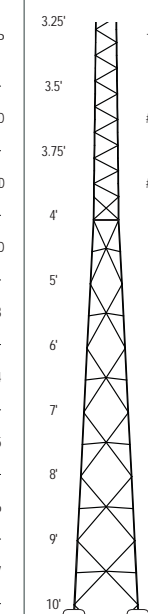
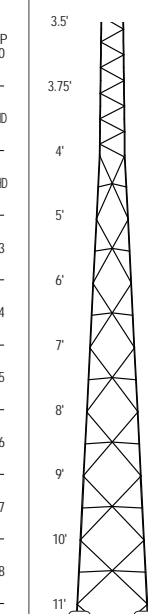
Model Designation:		S610	S800	S810	S900	S910	S1000	S1100
Knocked-down Part Number:		5.94.0610.090	5.94.0800.090	5.94.0810.090	5.94.0900.090	5.94.0910.090	5.94.1000.090	5.94.1100.090
Assembled Part Number:		N/A	N/A	N/A	N/A	N/A	N/A	N/A
<p>Includes anchor material for concrete foundation, splice hardware, and pipe anchor brackets for antenna mounting pipe (pipe sold separately on page 70).</p> <p>Models S610 to S1100 use base feet and tie-rods for concrete foundation.</p> <p>Knocked-down towers reduce shipping cost in comparison with pre-assembled.</p>								
Allowable antenna area in ft <sup>2</sup> at*	CSA Class 1** 10mm ice (350/450/550 Pa)	Round: 95/56/32 Flat: 63/37/21	Round: 123/72/41 Flat: 81/93/53	Round: 143/94/60 Flat: 95/63/40	Round: 150/112/78 Flat: 100/75/52	Round: 150/112/78 Flat: 100/75/52	Round: 165/123/85 Flat: 110/82/57	Round: 198/147/102 Flat: 110/123/112
	CSA Class 1** 25mm ice (350/450/550 Pa)	Round: 95/56/32 Flat: 63/37/21	Round: 123/72/41 Flat: 81/93/53	Round: 143/94/60 Flat: 95/63/40	Round: 150/112/78 Flat: 100/75/52	Round: 150/112/78 Flat: 100/75/52	Round: 165/123/85 Flat: 110/82/57	Round: 198/147/102 Flat: 110/123/112
	CSA Class 3** 25mm ice (350/450/550 Pa)	Round: 132/90/60 Flat: 88/60/40	Round: 169/118/83 Flat: 113/79/55	Round: 190/140/100 Flat: 127/93/67	Round: 200/150/112 Flat: 133/100/75	Round: 200/150/112 Flat: 133/100/75	Round: 220/165/123 Flat: 146/110/82	Round: 360/260/198 Flat: 240/173/132
Knocked-down Towers	L"xW"xH"	133x48x58	133x48x58	133x48x58	133x96x40	133x96x40	133x96x40	133x96x40
Assembled Towers	L"xW"xH"	N/A	N/A	N/A	N/A	N/A	N/A	N/A
Shipping Weight (lbs)		5,289	6,207	6,254	6,815	6,862	7,469	8,027

\*Assumptions: Projected areas (PA) shown are bare; a 1.5 multiplier used for iced area; loads centrally located and balanced at tower top; considers step-pegs, safety cable, and one 1/2" tx line per 10 sq.ft.; "-" indicates tower failure.  
 \*\* For examples of CSA Class 1 vs Class 3, see page 28.

## Common Accessories

Accessory:	S610	S800	S810	S900	S910	S1000	S1100
<b>Cable Safety Climb Kits</b> no slider	4.99.0485.100	4.99.0485.100	4.99.0485.100	4.99.0485.100	4.99.0485.100	4.99.0485.100	4.99.0485.100
<b>Step-Bolt Kit</b> leg mounted	4.98.S600.090	4.98.S800.090	4.98.S800.090	4.98.S900.090	4.98.S900.090	4.98.1000.090	4.98.1100.090
<b>Anti-Climb Shield Kits</b>	4.92.0001.213	4.92.0001.213	4.92.0001.213	4.92.0001.213	4.92.0001.213	4.92.0001.213	4.92.0001.213
<b>Tower Grounding Kit</b> basic, single leg	4.91.0103.003	4.91.0103.003	4.91.0103.003	4.91.0103.003	4.91.0103.003	4.91.0103.003	4.91.0103.003

For more SuperTITAN Accessories and Replacement Parts, see pages 61 to 76.

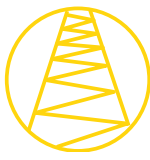

Model Designation:		S100	S200	S300	H300	H310	S500	S510
Knocked-down Part Number:		5.94.0100.100	5.94.0200.100	5.94.0300.100	5.94.H300.100	5.94.H310.100	5.94.0500.100	5.94.0510.100
Assembled Part Number:		5.95.0100.100	5.95.0200.100	5.95.0300.100	5.95.H300.100	5.95.H310.100	N/A	N/A
<p>Includes anchor material for concrete foundation, splice hardware, and pipe anchor brackets for antenna mounting pipe (pipe sold separately on page 70).</p> <p>Models S100 to H310 use a 5' embedment section as the anchor for concrete; models S500 to S510 use base feet and tie-rods for concrete foundation.</p> <p>Knocked-down towers reduce shipping cost in comparison with pre-assembled.</p>								
Allowable antenna area in ft² at*	CSA Class 1** 10mm ice (350/450/550 Pa)	Round: --/-- Flat: --/--	Round: 3/-- Flat: 2/--	Round: 3/-- Flat: 2/--	Round: 20/5-- Flat: 14/3--	Round: 36/18/3 Flat: 24/12/2	Round: 55/30/13 Flat: 39/21/9	Round: 70/36/16 Flat: 47/24/11
	CSA Class 1** 25mm ice (350/450/550 Pa)	Round: --/-- Flat: --/--	Round: 3/-- Flat: 2/--	Round: 3/-- Flat: 2/--	Round: 20/5-- Flat: 14/3--	Round: 36/18/3 Flat: 24/12/2	Round: 50/30/13 Flat: 35/21/9	Round: 70/36/16 Flat: 47/24/11
	CSA Class 3** 25mm ice (350/450/550 Pa)	Round: 19/1-- Flat: 13/5--	Round: 24/5-- Flat: 16/3--	Round: 24/4-- Flat: 16/3--	Round: 44/22/9 Flat: 29/14/6	Round: 56/34/20 Flat: 37/23/13	Round: 89/59/38 Flat: 59/39/25	Round: 104/66/40 Flat: 69/44/27
Knocked-down Towers	L"xW"xH"	133x48x34	133x48x35	133x48x42	133x48x45	133x48x45	133x48x55	133x48x55
Assembled Towers	L"xW"xH"	133x75x49	133x75x52	133x75x55	133x75x55	133x75x55	N/A	N/A
Shipping Weight (lbs)		2,974	3,199	3,463	3,774	3,821	5,457	5,504

\*Assumptions: Projected areas (PA) shown are bare; a 1.5 multiplier used for iced area; loads centrally located and balanced at tower top; considers step-pegs, safety cable, and one 1/2" tx line per 10 sq.ft.; "--" indicates tower failure. \*\* For examples of CSA Class 1 vs Class 3, see page 28.

## Common Accessories

Accessory:	S100	S200	S300	H300	H310	S500	S510
<b>Cable Safety Climb Kits</b> no slider	4.99.0485.100	4.99.0485.100	4.99.0485.100	4.99.0485.100	4.99.0485.100	4.99.0485.100	4.99.0485.100
<b>Step-Bolt Kit</b> leg mounted	4.98.0100.100	4.98.0100.100	4.98.0100.100	4.98.0100.100	4.98.0100.100	4.98.S500.100	4.98.S500.100
<b>Anti-Climb Shield Kits</b>	4.92.0001.010	4.92.0001.011	4.92.0001.012	4.92.0001.012	4.92.0001.012	4.92.0001.213	4.92.0001.213
<b>Tower Grounding Kit</b> basic, single leg	4.91.0103.000	4.91.0103.000	4.91.0103.000	4.91.0103.000	4.91.0103.000	4.91.0103.003	4.91.0103.003

For more SuperTITAN Accessories and Replacement Parts, see pages 61 to 76.

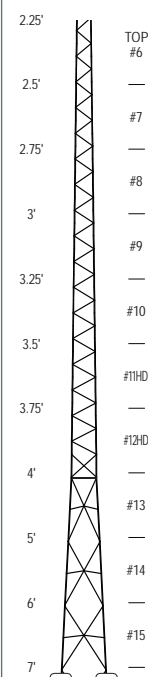
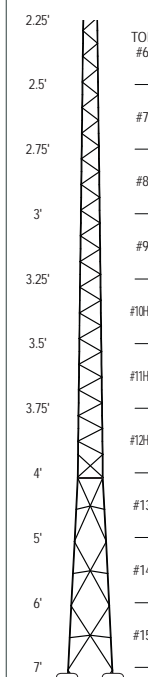
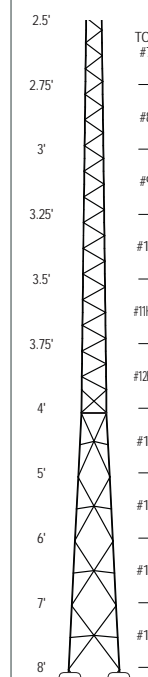
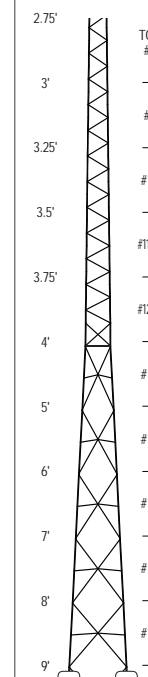
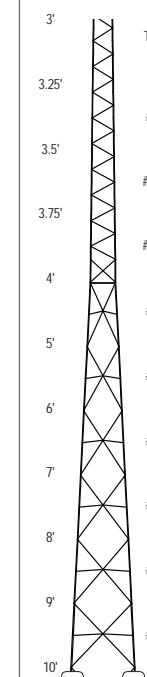
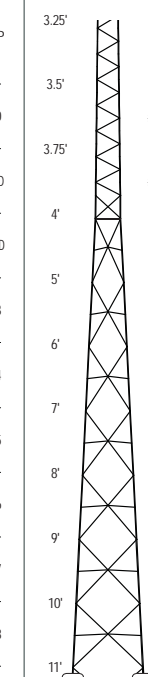
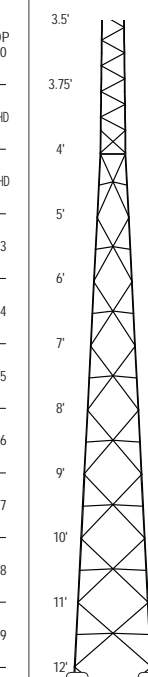
Model Designation:		S600	S610	S700	S800	S900	S1000	S1100
Knocked-down Part Number:		5.94.0600.100	5.94.0610.100	5.94.0700.100	5.94.0800.100	5.94.0900.100	5.94.1000.100	5.94.1100.100
Assembled Part Number:		N/A	N/A	N/A	N/A	N/A	N/A	N/A
<p>Includes anchor material for concrete foundation, splice hardware, and pipe anchor brackets for antenna mounting pipe (pipe sold separately on page 70).</p> <p>Models S600 to S1100 use base feet and tie-rods for concrete foundation.</p> <p>Knocked-down towers reduce shipping cost in comparison with pre-assembled.</p>								
Allowable antenna area in ft <sup>2</sup> at*	CSA Class 1** 10mm ice (350/450/550 Pa)	Round: 77/40/18 Flat: 52/26/12	Round: 88/52/30 Flat: 59/35/20	Round: 97/57/33 Flat: 65/39/22	Round: 116/68/39 Flat: 78/46/26	Round: 139/81/46 Flat: 93/55/31	Round: 166/97/55 Flat: 111/66/37	Round: 199/116/66 Flat: 133/79/44
	CSA Class 1** 25mm ice (350/450/550 Pa)	Round: 61/39/21 Flat: 43/27/15	Round: 88/52/30 Flat: 59/35/20	Round: 97/57/33 Flat: 65/39/22	Round: 116/68/39 Flat: 78/46/26	Round: 139/81/46 Flat: 93/55/31	Round: 166/97/55 Flat: 111/66/37	Round: 199/116/66 Flat: 133/79/44
	CSA Class 3** 25mm ice (350/450/550 Pa)	Round: 122/84/61 Flat: 81/56/41	Round: 130/84/54 Flat: 87/56/36	Round: 160/104/72 Flat: 107/69/48	Round: 163/114/80 Flat: 109/76/53	Round: 171/122/92 Flat: 114/81/61	Round: 178/130/104 Flat: 119/87/69	Round: 348/252/194 Flat: 232/168/129
Knocked-down Towers	L"xW"xH"	133x48x58	133x48x58	133x48x58	133x96x40	133x96x40	133x96x40	133x96x40
Assembled Towers	L"xW"xH"	N/A	N/A	N/A	N/A	N/A	N/A	N/A
Shipping Weight (lbs)		6,008	6,055	6,512	7,130	7,788	8,465	9,024

\*Assumptions: Projected areas (PA) shown are bare; a 1.5 multiplier used for iced area; loads centrally located and balanced at tower top; considers step-pegs, safety cable, and one 1/2" tx line per 10 sq.ft.; "-" indicates tower failure.  
 \*\* For examples of CSA Class 1 vs Class 3, see page 28.

## Common Accessories

Accessory:	S600	S610	S700	S800	S900	S1000	S1100
<b>Cable Safety Climb Kits</b> no slider	4.99.0485.100	4.99.0485.100	4.99.0485.100	4.99.0485.100	4.99.0485.100	4.99.0485.100	4.99.0485.100
<b>Step-Bolt Kit</b> leg mounted	4.98.S600.100	4.98.S600.100	4.98.S700.100	4.98.S800.100	4.98.S900.100	4.98.1000.100	4.98.1100.100
<b>Anti-Climb Shield Kits</b>	4.92.0001.213	4.92.0001.213	4.92.0001.213	4.92.0001.213	4.92.0001.213	4.92.0001.213	4.92.0001.213
<b>Tower Grounding Kit</b> basic, single leg	4.91.0103.003	4.91.0103.003	4.91.0103.003	4.91.0103.003	4.91.0103.003	4.91.0103.003	4.91.0103.003

For more SuperTITAN Accessories and Replacement Parts, see pages 61 to 76.

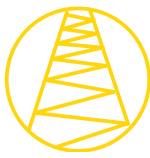

Model Designation:		S100	S200	H200	H210	S400	S410	S500
Knocked-down Part Number:		5.94.0100.110	5.94.0200.110	5.94.H200.110	5.94.H210.110	5.94.0400.110	5.94.0410.110	5.94.0500.110
Assembled Part Number:		5.95.0100.110	5.95.0200.110	5.95.H200.110	5.95.H210.110	N/A	N/A	N/A
Includes anchor material for concrete foundation, splice hardware, and pipe anchor brackets for antenna mounting pipe (pipe sold separately on page 70). Models S100 to H210 use a 5' embedment section as the anchor for concrete; models S400 to S500 use base feet and tie-rods for concrete foundation. Knocked-down towers reduce shipping cost in comparison with pre-assembled.								
Allowable antenna area in ft <sup>2</sup> at*	CSA Class 1** 10mm ice (350/450/550 Pa)	Round: --/-- Flat: --/--	Round: --/-- Flat: --/--	Round: 9/-- Flat: 6/--	Round: 20/6-- Flat: 13/4--	Round: 32/15-- Flat: 22/10--	Round: 50/20/2 Flat: 33/13/1	Round: 55/22/3 Flat: 36/14/2
	CSA Class 1** 25mm ice (350/450/550 Pa)	Round: --/-- Flat: --/--	Round: --/-- Flat: --/--	Round: 9/-- Flat: 6/--	Round: 20/5-- Flat: 13/3--	Round: 30/15-- Flat: 21/10--	Round: 50/20/2 Flat: 33/13/1	Round: 55/22/3 Flat: 36/14/2
	CSA Class 3** 25mm ice (350/450/550 Pa)	Round: 12/-- Flat: 8/--	Round: 12/-- Flat: 12/--	Round: 28/-- Flat: 18/--	Round: 34/19/7 Flat: 23/13/5	Round: 61/37/20 Flat: 41/25/13	Round: 78/46/22 Flat: 52/31/15	Round: 86/50/24 Flat: 57/41/17
Knocked-down Towers	L"xW"xH"	133x48x42	133x48x42	133x48x45	133x48x45	133x48x57	133x48x57	133x48x49
Assembled Towers	L"xW"xH"	133x75x55	133x75x55	133x75x55	133x75x55	N/A	N/A	N/A
Shipping Weight (lbs)		3,477	3,666	3,977	4,024	5,669	5,716	6,223

\*Assumptions: Projected areas (PA) shown are bare; a 1.5 multiplier used for iced area; loads centrally located and balanced at tower top; considers step-pegs, safety cable, and one 1/2" tx line per 10 sq.ft.; "--" indicates tower failure. \*\* For examples of CSA Class 1 vs Class 3, see page 28.

## Common Accessories

Accessory:	S100	S200	H200	H210	S400	S410	S500
<b>Cable Safety Climb Kits</b> no slider	4.99.0485.150	4.99.0485.150	4.99.0485.150	4.99.0485.150	4.99.0485.150	4.99.0485.150	4.99.0485.150
<b>Step-Bolt Kit</b> leg mounted	4.98.0100.110	4.98.0100.110	4.98.0100.110	4.98.0100.110	4.98.S400.110	4.98.S400.110	4.98.S500.110
<b>Anti-Climb Shield Kits</b>	4.92.0001.011	4.92.0001.012	4.92.0001.012	4.92.0001.012	4.92.0001.213	4.92.0001.213	4.92.0001.213

For more SuperTITAN Accessories and Replacement Parts, see pages 61 to 76.

# 110' Towers continued



Model Designation:		S510	S600	S700	S800	S900	S1000	S1100
Knocked-down Part Number:		5.94.0510.110	5.94.0600.110	5.94.0700.110	5.94.0800.110	5.94.0900.110	5.94.1000.110	5.94.1100.110
Assembled Part Number:		N/A	N/A	N/A	N/A	N/A	N/A	N/A
Includes anchor material for concrete foundation, splice hardware, and pipe anchor brackets for antenna mounting pipe (pipe sold separately on page 70).  Models S510 to S1100 use base feet and tie-rods for concrete foundation.  Knocked-down towers reduce shipping cost in comparison with pre-assembled.								
Allowable antenna area in ft <sup>2</sup> at*	CSA Class 1** 10mm ice (350/450/550 Pa)	Round: 64/34/12 Flat: 43/23/8	Round: 70/37/13 Flat: 47/25/9	Round: 92/48/21 Flat: 61/36/14	Round: 110/57/25 Flat: 73/43/16	Round: 132/68/30 Flat: 87/51/13	Round: 158/82/36 Flat: 104/61/16	Round: 220/147/104 Flat: 146/98/69
	CSA Class 1** 25mm ice (350/450/550 Pa)	Round: 64/32/12 Flat: 43/21/8	Round: 70/37/13 Flat: 47/25/9	Round: 92/48/21 Flat: 61/36/14	Round: 110/57/25 Flat: 73/43/16	Round: 132/68/30 Flat: 87/51/13	Round: 158/82/36 Flat: 104/61/16	Round: 220/147/104 Flat: 146/98/69
	CSA Class 3** 25mm ice (350/450/550 Pa)	Round: 96/60/34 Flat: 64/40/23	Round: 120/78/48 Flat: 80/52/36	Round: 155/100/62 Flat: 103/67/41	Round: 155/104/74 Flat: 103/69/49	Round: 165/121/90 Flat: 110/81/60	Round: 172/132/100 Flat: 115/88/67	Round: 295/209/154 Flat: 196/139/102
Knocked-down Towers	L"xW"xH"	133x48x49	133x96x40	133x96x40	133x96x40	133x96x40	133x96x40	133x96x48
Assembled Towers	L"xW"xH"	N/A	N/A	N/A	N/A	N/A	N/A	N/A
Shipping Weight (lbs)		6,270	6,866	7,435	8,103	8,777	9,455	10,120

\*Assumptions: Projected areas (PA) shown are bare; a 1.5 multiplier used for iced area; loads centrally located and balanced at tower top; considers step-pegs, safety cable, and one 1/2" tx line per 10 sq.ft.; "-" indicates tower failure.  
\*\* For examples of CSA Class 1 vs Class 3, see page 28.

## Common Accessories

Accessory:	S510	S600	S700	S800	S900	S1000	S1100
<b>Cable Safety Climb Kits</b> no slider	4.99.0485.150	4.99.0485.150	4.99.0485.150	4.99.0485.150	4.99.0485.150	4.99.0485.150	4.99.0485.150
<b>Step-Bolt Kit</b> leg mounted	4.98.S500.110	4.98.S600.110	4.98.S700.110	4.98.S800.110	4.98.S900.110	4.98.1000.110	4.98.1100.110
<b>Anti-Climb Shield Kits</b>	4.92.0001.213	4.92.0001.213	4.92.0001.213	4.92.0001.213	4.92.0001.213	4.92.0001.213	4.92.0001.213

For more SuperTITAN Accessories and Replacement Parts, see pages 61 to 76.



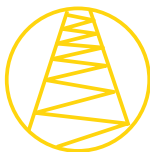

Model Designation:		S100	H100	H110	S300	S310	S400	S410
Knocked-down Part Number:		5.94.0100.120	5.94.H100.120	5.94.H110.120	5.94.0300.120	5.94.0310.120	5.94.0400.120	5.94.0410.120
Assembled Part Number:		5.95.0100.120	5.95.H100.120	5.95.H110.120	N/A	N/A	N/A	N/A
<p>Includes anchor material for concrete foundation, splice hardware, and pipe anchor brackets for antenna mounting pipe (pipe sold separately on page 70).</p> <p>Models S100 to H110 use a 5' embedment section as the anchor for concrete; models S300 to S410 use base feet and tie-rods for concrete foundation.</p> <p>Knocked-down towers reduce shipping cost in comparison with pre-assembled.</p>								
Allowable antenna area in ft² at*	CSA Class 1** 10mm ice (350/450/550 Pa)	Round: --/-- Flat: --/--	Round: --/-- Flat: --/--	Round: 8/-- Flat: 5/--	Round: 17/2-- Flat: 12/1--	Round: TBA Flat: TBA	Round: 30/13-- Flat: 21/9--	Round: TBA Flat: TBA
	CSA Class 1** 25mm ice (350/450/550 Pa)	Round: --/-- Flat: --/--	Round: --/-- Flat: --/--	Round: 8/-- Flat: 5/--	Round: 17/2-- Flat: 12/1--	Round: TBA Flat: TBA	Round: 30/13-- Flat: 21/9--	Round: TBA Flat: TBA
	CSA Class 3** 25mm ice (350/450/550 Pa)	Round: --/-- Flat: --/--	Round: 16/-- Flat: 10/--	Round: 16/-- Flat: 11/--	Round: 60/20/6 Flat: 40/13/4	Round: TBA Flat: TBA	Round: 59/34/19 Flat: 39/23/13	Round: TBA Flat: TBA
Knocked-down Towers	L"xW"xH"	133x48x50	133x48x53	133x48x53	133x48x57	133x48x57	133x48x63	133x48x63
Assembled Towers	L"xW"xH"	133x75x55	133x75x55	133x75x55	N/A	N/A	N/A	N/A
Shipping Weight (lbs)		3,894	4,180	4,228	5,878	5,925	6,435	6,482

\*Assumptions: Projected areas (PA) shown are bare; a 1.5 multiplier used for iced area; loads centrally located and balanced at tower top; considers step-pegs, safety cable, and one 1/2" tx line per 10 sq.ft.; "-" indicates tower failure.  
 \*\* For examples of CSA Class 1 vs Class 3, see page 28.

## Common Accessories

Accessory	S100	H100	H110	S300	S310	S400	S410
<b>Cable Safety Climb Kits</b> no slider	4.99.0485.150	4.99.0485.150	4.99.0485.150	4.99.0485.150	4.99.0485.150	4.99.0485.150	4.99.0485.150
<b>Step-Bolt Kit</b> leg mounted	4.98.0100.120	4.98.0100.120	4.98.0100.120	4.98.S300.120	4.98.S300.120	4.98.S400.120	4.98.S400.120

For more SuperTITAN Accessories and Replacement Parts, see pages 61 to 76.



# 120' Towers continued



Model Designation:		S500	S600	S700	S800	S810	S910	S1010
Knocked-down Part Number:		5.94.0500.120	5.94.0600.120	5.94.0700.120	5.94.0800.120	5.94.0810.120	5.94.0910.120	5.94.1010.120
Assembled Part Number:		N/A	N/A	N/A	N/A	N/A	N/A	N/A
Includes anchor material for concrete foundation, splice hardware, and pipe anchor brackets for antenna mounting pipe (pipe sold separately on page 70).  Models S500 to S1010 use base feet and tie-rods for concrete foundation.								
Allowable antenna area in ft <sup>2</sup> at*	CSA Class 1** 10mm ice (350/450/550 Pa)	Round: 51/20/2 Flat: 36/14/1	Round: 63/30/9 Flat: 45/21/6	Round: 63/39/20 Flat: 45/27/14	Round: 70/48/33 Flat: 50/34/23	Round: 72/51/38 Flat: 51/36/27	Round: 80/60/48 Flat: 57/42/34	Round: TBA Flat: TBA
	CSA Class 1** 25mm ice (350/450/550 Pa)	Round: 40/20/2 Flat: 28/14/1	Round: 50/30/9 Flat: 35/21/6	Round: 63/39/20 Flat: 45/27/14	Round: 65/48/33 Flat: 46/34/23	Round: 72/51/38 Flat: 51/36/27	Round: 80/60/48 Flat: 57/42/34	Round: TBA Flat: TBA
	CSA Class 3** 25mm ice (350/450/550 Pa)	Round: 82/54/31 Flat: 55/23/13	Round: 117/74/31 Flat: 78/49/27	Round: 146/92/58 Flat: 97/61/39	Round: 154/106/76 Flat: 103/71/51	Round: 162/112/84 Flat: 108/75/56	Round: 172/129/99 Flat: 115/86/66	Round: TBA Flat: TBA
Knocked-down Towers	L"xW"xH"	133x96x36	133x96x36	133x96x40	133x96x40	133x96x48	133x96x50	133x96x50
Assembled Towers	L"xW"xH"	N/A	N/A	N/A	N/A	N/A	N/A	N/A
Shipping Weight (lbs)		7,081	7,714	8,408	9,092	9,849	10,551	10,598

\*Assumptions: Projected areas (PA) shown are bare; a 1.5 multiplier used for iced area; loads centrally located and balanced at tower top; considers step-pegs, safety cable, and one 1/2" tx line per 10 sq.ft.; "-" indicates tower failure.  
\*\* For examples of CSA Class 1 vs Class 3, see page 28.

## Common Accessories

Accessory	S500	S600	S700	S800	S810	S910	S1010
<b>Cable Safety Climb Kits</b> no slider	4.99.0485.150	4.99.0485.150	4.99.0485.150	4.99.0485.150	4.99.0485.150	4.99.0485.150	4.99.0485.150
<b>Step-Bolt Kit</b> leg mounted	4.98.S500.120	4.98.S600.120	4.98.S700.120	4.98.S800.120	4.98.S800.120	4.98.S900.120	4.98.1000.120

For more SuperTITAN Accessories and Replacement Parts, see pages 61 to 76.



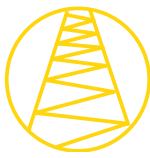

Model Designation:		S300	S310	S400	S410	S500	S510	S600
Part Number:		5.94.0300.130	5.94.0310.130	5.94.0400.130	5.94.0410.130	5.94.0500.130	5.94.0510.130	5.94.0600.130
<p>Due to the weight, towers on this page are not available in pre-assembled 10' sections. They ship in "knock-down" format and require field assembly by experienced, professional, tower installers.</p> <p>Trylon Distributors will stock individual 10', knock-down sections, therefore customers may choose to order towers by the section (see pages 58 and 59), rather than a complete tower kit. Ordering by section also facilitates choosing a different foundation/anchorage system versus the anchor bolts and base feet supplied in kit format.</p> <p>For example, to order the 130' S300, one can use the kit number 5.94.0300.130. Alternatively, one could order sections #3 Top, #4, #5, etc.</p> <p>Models S300 to S600 include all 10' sections, base feet and tie-rods, splice hardware, and angle frame brackets to support a top antenna mounting pipe (pipe sold separately on page 70).</p>								
Allowable antenna area in ft² at*	CSA Class 1** 10mm ice (350/450/550 Pa)	Round: 16/1/-- Flat: 11/--/--	Round: TBA Flat: TBA	Round: 30/10/-- Flat: 21/7/--	Round: TBA Flat: TBA	Round: 46/15/-- Flat: 32/10/--	Round: TBA Flat: TBA	Round: 60/28/5 Flat: 42/20/3
	CSA Class 1** 25mm ice (350/450/550 Pa)	Round: 16/1/-- Flat: 11/--/--	Round: TBA Flat: TBA	Round: 30/10/-- Flat: 21/7/--	Round: TBA Flat: TBA	Round: 40/15/-- Flat: 28/10/--	Round: TBA Flat: TBA	Round: 50/28/5 Flat: 35/20/3
	CSA Class 3** 25mm ice (350/450/550 Pa)	Round: 40/19/3 Flat: 27/13/2	Round: TBA Flat: TBA	Round: 58/32/17 Flat: 39/21/11	Round: TBA Flat: TBA	Round: 81/52/24 Flat: 54/35/16	Round: TBA Flat: TBA	Round: 115/66/36 Flat: 77/44/24
Shipping Dimensions (LxWxH")		133x96x40	133x96x40	133x96x40	133x96x40	133x96x40	133x96x40	133x96x40
Shipping Weight (lbs)		6,719	6,766	7,293	7,340	7,929	7,976	8,687

\*Assumptions: Projected areas (PA) shown are bare; a 1.5 multiplier used for iced area; loads centrally located and balanced at tower top; considers step-pegs, safety cable, and one 1/2" tx line per 10 sq.ft.; "--" indicates tower failure.  
 \*\* For examples of CSA Class 1 vs Class 3, see page 28.

## Common Accessories

Accessory	S300	S310	S400	S410	S500	S510	S600
<b>Cable Safety Climb Kits</b> no slider	4.99.0485.150	4.99.0485.150	4.99.0485.150	4.99.0485.150	4.99.0485.150	4.99.0485.150	4.99.0485.150
<b>Step-Bolt Kit</b> leg mounted	4.98.S300.130	4.98.S300.130	4.98.S400.130	4.98.S400.130	4.98.S500.130	4.98.S500.130	4.98.S600.130

For more SuperTITAN Accessories and Replacement Parts, see pages 61 to 76.

# 130' Towers continued



Model Designation:	S610	S700	S710	S800	S810	S900	S910	
Part Number:	5.94.0610.130	5.94.0700.130	5.94.0710.130	5.94.0800.130	5.94.0810.130	5.94.0900.130	5.94.0910.130	
<p>Due to the weight, towers on this page are not available in pre-assembled 10' sections. They ship in "knock-down" format and require field assembly by experienced, professional, tower installers.</p> <p>Trylon Distributors will stock individual 10', knock-down sections, therefore customers may choose to order towers by the section (see pages 58 and 59), rather than a complete tower kit. Ordering by section also facilitates choosing a different foundation/anchorage system versus the anchor bolts and base feet supplied in kit format.</p> <p>For example, to order the 130' S300, one can use the kit number 5.94.0300.130. Alternatively, one could order sections #3 Top, #4, #5, etc.</p> <p>Models S610 to S900 include all 10' sections, base feet and tie-rods, splice hardware, and angle frame brackets to support a top antenna mounting pipe (pipe sold separately on page 70).</p>								
Allowable antenna area in ft <sup>2</sup> at*	CSA Class 1** 10mm ice (350/450/550 Pa)	Round: TBA Flat: TBA	Round: 60/37/19 Flat: 42/26/13	Round: TBA Flat: TBA	Round: 69/47/31 Flat: 49/33/22	Round: TBA Flat: TBA	Round: 70/50/37 Flat: 50/35/26	Round: TBA Flat: TBA
	CSA Class 1** 25mm ice (350/450/550 Pa)	Round: TBA Flat: TBA	Round: 60/37/19 Flat: 42/26/13	Round: TBA Flat: TBA	Round: 69/47/31 Flat: 49/33/22	Round: TBA Flat: TBA	Round: 70/50/27 Flat: 50/35/26	Round: TBA Flat: TBA
	CSA Class 3** 25mm ice (350/450/550 Pa)	Round: TBA Flat: TBA	Round: 144/88/54 Flat: 96/59/36	Round: TBA Flat: TBA	Round: 154/102/74 Flat: 103/68/49	Round: TBA Flat: TBA	Round: 158/112/84 Flat: 105/75/56	Round: TBA Flat: TBA
Shipping Dimensions (L"xW"xH")	133x96x40	133x96x40	133x96x40	133x96x48	133x96x48	133x96x48	133x96x48	
Shipping Weight (lbs)	8,734	9,397	9,444	10,164	10,211	10,870	10,917	

\*Assumptions: Projected areas (PA) shown are bare; a 1.5 multiplier used for iced area; loads centrally located and balanced at tower top; considers step-pegs, safety cable, and one 1/2" tx line per 10 sq.ft.; "-" indicates tower failure.  
 \*\* For examples of CSA Class 1 vs Class 3, see page 28.

## Common Accessories

Accessory	S610	S700	S710	S800	S810	S900	S910
Cable Safety Climb Kits no slider	4.99.0485.150	4.99.0485.150	4.99.0485.150	4.99.0485.150	4.99.0485.150	4.99.0485.150	4.99.0485.150
Step-Bolt Kit leg mounted	4.98.S600.130	4.98.S700.130	4.98.S700.130	4.98.S800.130	4.98.S800.130	4.98.S900.130	4.98.S900.130

For more SuperTITAN Accessories and Replacement Parts, see pages 61 to 76.



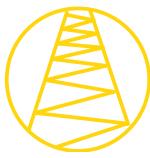

Model Designation:		S300	S310	S400	S410	S500	S510	S600
Part Number:		5.94.0300.140	5.94.0310.140	5.94.0400.140	5.94.0410.140	5.94.0500.140	5.94.0510.140	5.94.0600.140
<p>Due to the weight, towers on this page are not available in pre-assembled 10' sections. They ship in "knock-down" format and require field assembly by experienced, professional, tower installers.</p> <p>Trylon Distributors will stock individual 10', knock-down sections, therefore customers may choose to order towers by the section (see pages 58 and 59), rather than a complete tower kit. Ordering by section also facilitates choosing a different foundation/anchorage system versus the anchor bolts and base feet supplied in kit format.</p> <p>For example, to order the 140' S300, one can use the kit number 5.94.0300.140. Alternatively, one could order sections #3 Top, #4, #5, etc.</p> <p>Models S300 to S600 include all 10' sections, base feet and tie-rods, splice hardware, and angle frame brackets to support a top antenna mounting pipe (pipe sold separately on page 70).</p>								
Allowable antenna area in ft² at*	CSA Class 1** 10mm ice (350/450/550 Pa)	Round: 15/--/-- Flat: 10/--/--	Round: TBA Flat: TBA	Round: 28/4/-- Flat: 20/2/--	Round: TBA Flat: TBA	Round: 42/13/-- Flat: 30/9/--	Round: TBA Flat: TBA	Round: 58/25/3 Flat: 41/17/2
	CSA Class 1** 25mm ice (350/450/550 Pa)	Round: 15/--/-- Flat: 10/--/--	Round: TBA Flat: TBA	Round: 27/4/-- Flat: 19/2/--	Round: TBA Flat: TBA	Round: 40/13/-- Flat: 28/9/--	Round: TBA Flat: TBA	Round: 50/25/3 Flat: 35/17/2
	CSA Class 3** 25mm ice (350/450/550 Pa)	Round: 38/17/3 Flat: 25/11/2	Round: TBA Flat: TBA	Round: 55/32/11 Flat: 37/21/7	Round: TBA Flat: TBA	Round: 80/48/21 Flat: 53/32/14	Round: TBA Flat: TBA	Round: 112/64/36 Flat: 75/43/24
Shipping Dimensions (L"xW"xH")		133x96x40	133x96x40	133x96x40	133x96x40	133x96x40	133x96x40	133x96x40
Shipping Weight (lbs)		7,502	7,549	8,141	8,188	8,902	8,949	9,676

\*Assumptions: Projected areas (PA) shown are bare; a 1.5 multiplier used for iced area; loads centrally located and balanced at tower top; considers step-pegs, safety cable, and one 1/2" tx line per 10 sq.ft.; "--" indicates tower failure. \*\* For examples of CSA Class 1 vs Class 3, see page 28.

## Common Accessories

Accessory	S300	S310	S400	S410	S500	S510	S600
<b>Cable Safety Climb Kits</b> no slider	4.99.0485.150	4.99.0485.150	4.99.0485.150	4.99.0485.150	4.99.0485.150	4.99.0485.150	4.99.0485.150
<b>Step-Bolt Kit</b> leg mounted	4.98.S300.140	4.98.S300.140	4.98.S400.140	4.98.S400.140	4.98.S500.140	4.98.S500.140	4.98.S600.140

For more SuperTITAN Accessories and Replacement Parts, see pages 61 to 76.

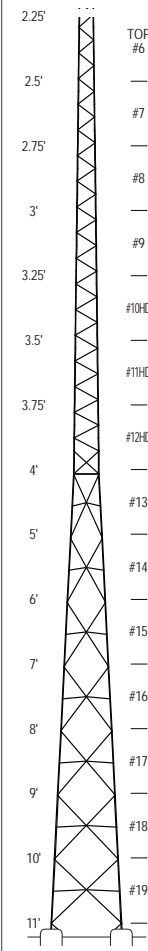
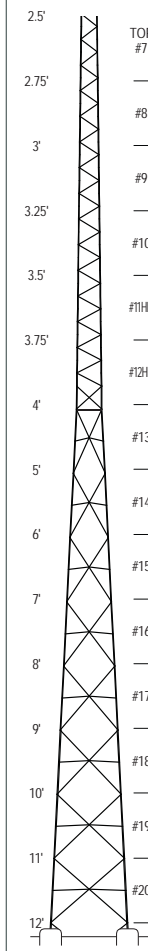
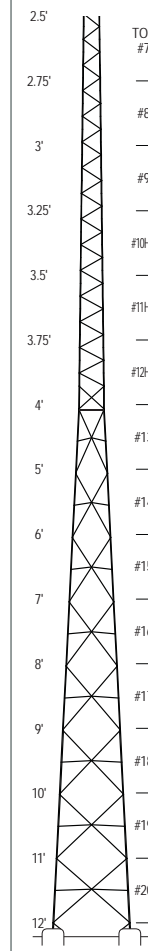
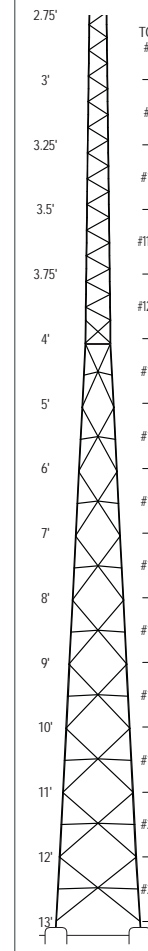
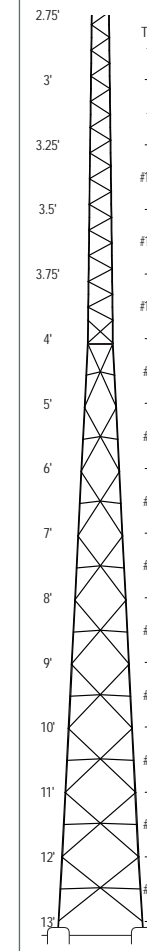
Model Designation:		S610	S700	S710	S800	S810		
Part Number:		5.94.0610.140	5.94.0700.140	5.94.0710.140	5.94.0800.140	5.94.0810.140		
<p>Due to the weight, towers on this page are not available in pre-assembled 10' sections. They ship in "knock-down" format and require field assembly by experienced, professional, tower installers.</p> <p>Trylon Distributors will stock individual 10', knock-down sections, therefore customers may choose to order towers by the section (see pages 58 and 59), rather than a complete tower kit. Ordering by section also facilitates choosing a different foundation/anchorage system versus the anchor bolts and base feet supplied in kit format.</p> <p>For example, to order the 140' S300, one can use the kit number 5.94.0300.140. Alternatively, one could order sections #3 Top, #4, #5, etc.</p> <p>Models S610 to S810 include all 10' sections, base feet and tie-rods, splice hardware, and angle frame brackets to support a top antenna mounting pipe (pipe sold separately on page 70).</p>								
Allowable antenna area in ft <sup>2</sup> at*	CSA Class 1** 10mm ice (350/450/550 Pa)	Round: TBA Flat: TBA	Round: 60/36/15 Flat: 42/25/10	Round: TBA Flat: TBA	Round: 67/45/31 Flat: 47/32/22	Round: TBA Flat: TBA		
	CSA Class 1** 25mm ice (350/450/550 Pa)	Round: TBA Flat: TBA	Round: 60/35/15 Flat: 42/25/10	Round: TBA Flat: TBA	Round: 67/45/31 Flat: 47/32/22	Round: TBA Flat: TBA		
	CSA Class 3** 25mm ice (350/450/550 Pa)	Round: TBA Flat: TBA	Round: 140/83/50 Flat: 93/55/33	Round: TBA Flat: TBA	Round: 150/101/72 Flat: 100/67/48	Round: TBA Flat: TBA		
Shipping Dimensions (L"xW"xH")		133x96x40	133x96x48	133x96x48	133x96x48	133x96x48		
Shipping Weight (lbs)		9,723	10,469	10,516	11,185	11,232		

\*Assumptions: Projected areas (PA) shown are bare; a 1.5 multiplier used for iced area; loads centrally located and balanced at tower top; considers step-pegs, safety cable, and one 1/2" tx line per 10 sq.ft.; "-" indicates tower failure.  
 \*\* For examples of CSA Class 1 vs Class 3, see page 28.

## Common Accessories

Accessory	S610	S700	S710	S800	S810		
<b>Cable Safety Climb Kits</b> no slider	4.99.0485.150	4.99.0485.150	4.99.0485.150	4.99.0485.150	4.99.0485.150		
<b>Step-Bolt Kit</b> leg mounted	4.98.S600.140	4.98.S700.140	4.98.S700.140	4.98.S800.140	4.98.S800.140		

For more SuperTITAN Accessories and Replacement Parts, see pages 61 to 76.

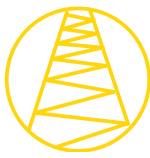

Model Designation:	S300	S310	S400	S410	S500	S510	S600	
Part Number:	5.94.0300.150	5.94.0310.150	5.94.0400.150	5.94.0410.150	5.94.0500.150	5.94.0510.150	5.94.0600.150	
Due to the weight, towers on this page are not available in pre-assembled 10' sections. They ship in "knock-down" format and require field assembly by experienced, professional, tower installers.  Trylon Distributors will stock individual 10', knock-down sections, therefore customers may choose to order towers by the section (see pages 58 and 59), rather than a complete tower kit. Ordering by section also facilitates choosing a different foundation/anchorage system versus the anchor bolts and base feet supplied in kit format.  For example, to order the 150' S300, one can use the kit number 5.94.0300.150. Alternatively, one could order sections #3 Top, #4, #5, etc.  Models S300 to S600 include all 10' sections, base feet and tie-rods, splice hardware, and angle frame brackets to support a top antenna mounting pipe (pipe sold separately on page 70).								
Allowable antenna area in ft² at*	CSA Class 1** 10mm ice (350/450/550 Pa)	Round: 14/--/-- Flat: 10/--/--	Round: TBA Flat: TBA	Round: 28/1/-- Flat: 20/--/--	Round: TBA Flat: TBA	Round: 40/10/-- Flat: 28/7/--	Round: TBA Flat: TBA	Round: 54/22/-- Flat: 38/15/--
	CSA Class 1** 25mm ice (350/450/550 Pa)	Round: 14/--/-- Flat: 10/--/--	Round: TBA Flat: TBA	Round: 27/1/-- Flat: 19/--/--	Round: TBA Flat: TBA	Round: 39/10/-- Flat: 27/7/--	Round: TBA Flat: TBA	Round: 48/22/-- Flat: 34/15/--
	CSA Class 3** 25mm ice (350/450/550 Pa)	Round: 36/16/-- Flat: 24/11/--	Round: TBA Flat: TBA	Round: 62/30/8 Flat: 41/20/5	Round: TBA Flat: TBA	Round: 76/45/20 Flat: 51/30/13	Round: TBA Flat: TBA	Round: 108/61/32 Flat: 72/41/21
Shipping Dimensions (L"xW"xH")	133x96x40	133x96x40	133x96x40	133x96x40	133x96x40	133x96x40	133x96x48	
Shipping Weight (lbs)	8,350	8,397	9,114	9,161	9,891	9,938	10,748	

\*Assumptions: Projected areas (PA) shown are bare; a 1.5 multiplier used for iced area; loads centrally located and balanced at tower top; considers step-pegs, safety cable, and one 1/2" tx line per 10 sq.ft.; "--" indicates tower failure.  
\*\* For examples of CSA Class 1 vs Class 3, see page 28.

## Common Accessories

Accessory	S300	S310	S400	S410	S500	S510	S600
<b>Step-Bolt Kit</b> leg mounted	4.98.S300.150	4.98.S300.150	4.98.S400.150	4.98.S400.150	4.98.S500.150	4.98.S500.150	4.98.S600.150

For more SuperTITAN Accessories and Replacement Parts, see pages 61 to 76.

# 150' Towers continued



Model Designation:		S610	S700	S710				
Part Number:		5.94.0610.150	5.94.0700.150	5.94.0710.150				
<p>Due to the weight, towers on this page are not available in pre-assembled 10' sections. They ship in "knock-down" format and require field assembly by experienced, professional, tower installers.</p> <p>Trylon Distributors will stock individual 10', knock-down sections, therefore customers may choose to order towers by the section (see pages 58 and 59), rather than a complete tower kit. Ordering by section also facilitates choosing a different foundation/anchorage system versus the anchor bolts and base feet supplied in kit format.</p> <p>For example, to order the 150' S300, one can use the kit number 5.94.0300.150. Alternatively, one could order sections #3 Top, #4, #5, etc.</p> <p>Models S610 to S710 include all 10' sections, base feet and tie-rods, splice hardware, and angle frame brackets to support a top antenna mounting pipe (pipe sold separately on page 70).</p>								
Allowable antenna area in ft <sup>2</sup> at*	CSA Class 1** 10mm ice (350/450/550 Pa)	Round: TBA Flat: TBA	Round: 58/33/13 Flat: 41/23/9	Round: TBA Flat: TBA				
	CSA Class 1** 25mm ice (350/450/550 Pa)	Round: TBA Flat: TBA	Round: 58/32/13 Flat: 41/22/9	Round: TBA Flat: TBA				
	CSA Class 3** 25mm ice (350/450/550 Pa)	Round: TBA Flat: TBA	Round: 134/83/49 Flat: 89/55/33	Round: TBA Flat: TBA				
Shipping Dimensions (L"xW"xH")		133x96x48	133x96x48	133x96x48				
Shipping Weight (lbs)		10,795	11,490	11,537				

\*Assumptions: Projected areas (PA) shown are bare; a 1.5 multiplier used for iced area; loads centrally located and balanced at tower top; considers step-pegs, safety cable, and one 1/2" tx line per 10 sq.ft.; "-" indicates tower failure. \*\* For examples of CSA Class 1 vs Class 3, see page 28.

## Common Accessories

Accessory	S610	S700	S710				
<b>Step-Bolt Kit</b> leg mounted	4.98.S600.150	4.98.S700.150	4.98.S700.150				

For more SuperTITAN Accessories and Replacement Parts, see pages 61 to 76.



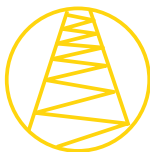

Model Designation:		S300	S310	S400	S500	S510	S600	S610
Part Number:		5.94.0300.160	5.94.0310.160	5.94.0400.160	5.94.0500.160	5.94.0510.160	5.94.0600.160	5.94.0610.160
<p>Due to the weight, towers on this page are not available in pre-assembled 10' sections. They ship in "knock-down" format and require field assembly by experienced, professional, tower installers.</p> <p>Trylon Distributors will stock individual 10', knock-down sections, therefore customers may choose to order towers by the section (see pages 58 and 59), rather than a complete tower kit. Ordering by section also facilitates choosing a different foundation/anchorage system versus the anchor bolts and base feet supplied in kit format.</p> <p>For example, to order the 160' S300, one can use the kit number 5.94.0300.160. Alternatively, one could order sections #3 Top, #4, #5, etc.</p> <p>Models S300 to S610 include all 10' sections, base feet and tie-rods, splice hardware, and angle frame brackets to support a top antenna mounting pipe (pipe sold separately on page 70).</p>								
Allowable antenna area in ft² at*	CSA Class 1** 10mm ice (350/450/550 Pa)	Round: 13/-- Flat: 9/--	Round: TBA Flat: TBA	Round: 27/-- Flat: 19/--	Round: 38/10/-- Flat: 27/7/--	Round: TBA Flat: TBA	Round: 52/20/-- Flat: 37/14/--	Round: TBA Flat: TBA
	CSA Class 1** 25mm ice (350/450/550 Pa)	Round: 13/-- Flat: 9/--	Round: TBA Flat: TBA	Round: 27/-- Flat: 19/--	Round: 33/10/-- Flat: 23/7/--	Round: TBA Flat: TBA	Round: 44/20/-- Flat: 31/14/--	Round: TBA Flat: TBA
	CSA Class 3** 25mm ice (350/450/550 Pa)	Round: 34/14/-- Flat: 23/9/--	Round: TBA Flat: TBA	Round: 52/29/5 Flat: 35/19/3	Round: 76/44/17 Flat: 51/29/11	Round: TBA Flat: TBA	Round: 104/60/29 Flat: 69/40/19	Round: TBA Flat: TBA
Shipping Dimensions (LxWxH")		133x96x40	133x96x40	133x96x48	133x96x48	133x96x48	133x96x48	133x96x48
Shipping Weight (lbs)		9,323	9,370	10,178	10,963	11,010	11,769	11,816

\*Assumptions: Projected areas (PA) shown are bare; a 1.5 multiplier used for iced area; loads centrally located and balanced at tower top; considers step-pegs, safety cable, and one 1/2" tx line per 10 sq.ft.; "--" indicates tower failure. \*\* For examples of CSA Class 1 vs Class 3, see page 28.

For more SuperTITAN Accessories and Replacement Parts, see pages 61 to 76.



# 170' Towers



Model Designation:	S300	S310	S400	S410	S500	S510	
Part Number:	5.94.0300.170	5.94.0310.170	5.94.0400.170	5.94.0410.170	5.94.0500.170	5.94.0510.170	
<p>Due to the weight, towers on this page are not available in pre-assembled 10' sections. They ship in "knock-down" format and require field assembly by experienced, professional, tower installers.</p> <p>Trylon Distributors will stock individual 10', knock-down sections, therefore customers may choose to order towers by the section (see pages 58 and 59), rather than a complete tower kit. Ordering by section also facilitates choosing a different foundation/anchorage system versus the anchor bolts and base feet supplied in kit format.</p> <p>For example, to order the 170' S300, one can use the kit number 5.94.0300.170. Alternatively, one could order sections #3 Top, #4, #5, etc.</p> <p>Models S300 to S510 include all 10' sections, base feet and tie-rods, splice hardware, and angle frame brackets to support a top antenna mounting pipe (pipe sold separately on page 70).</p>							
Allowable antenna area in ft <sup>2</sup> at*	CSA Class 1** 10mm ice (350/450/550 Pa)	Round: 11/--/ Flat: 7/--/	Round: TBA Flat: TBA	Round: 23/--/ Flat: 16/--/	Round: TBA Flat: TBA	Round: 35/8/--/ Flat: 25/5/--/	Round: TBA Flat: TBA
	CSA Class 1** 25mm ice (350/450/550 Pa)	Round: 11/--/ Flat: 7/--/	Round: TBA Flat: TBA	Round: 23/--/ Flat: 16/--/	Round: TBA Flat: TBA	Round: 31/8/--/ Flat: 22/5/--/	Round: TBA Flat: TBA
	CSA Class 3** 25mm ice (350/450/550 Pa)	Round: 34/12/--/ Flat: 23/8/--/	Round: TBA Flat: TBA	Round: 51/26/1 Flat: 34/17/1	Round: TBA Flat: TBA	Round: 74/40/14 Flat: 49/27/9	Round: TBA Flat: TBA
Shipping Dimensions (L"xW"xH")	133x96x53	133x96x53	133x96x54	133x96x54	133x96x54	133x96x54	
Shipping Weight (lbs)	10,387	10,434	11,175	11,222	11,984	12,064	

\*Assumptions: Projected areas (PA) shown are bare; a 1.5 multiplier used for iced area; loads centrally located and balanced at tower top; considers step-pegs, safety cable, and one 1/2" tx line per 10 sq.ft.; "--" indicates tower failure.  
 \*\* For examples of CSA Class 1 vs Class 3, see page 28.

For more SuperTITAN Accessories and Replacement Parts, see pages 61 to 76.



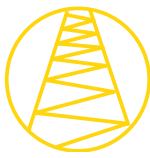

Model Designation:		S300	S310	S400	S410			
Part Number:		5.94.0300.180	5.94.0310.180	5.94.0400.180	5.94.0410.180			
<p>Due to the weight, towers on this page are not available in pre-assembled 10' sections. They ship in "knock-down" format and require field assembly by experienced, professional, tower installers.</p> <p>Trylon Distributors will stock individual 10', knock-down sections, therefore customers may choose to order towers by the section (see pages 58 and 59), rather than a complete tower kit. Ordering by section also facilitates choosing a different foundation/anchorage system versus the anchor bolts and base feet supplied in kit format.</p> <p>For example, to order the 180' S300, one can use the kit number 5.94.0300.180. Alternatively, one could order sections #3 Top, #4, #5, etc.</p> <p>Models S300 and S410 include all 10' sections, base feet and tie-rods, splice hardware, and angle frame brackets to support a top antenna mounting pipe (pipe sold separately on page 70).</p>								
Allowable antenna area in ft² at*	CSA Class 1** 10mm ice (350/450/550 Pa)	Round: 10/-- Flat: 7/--	Round: TBA Flat: TBA	Round: 21/-- Flat: 15/--	Round: TBA Flat: TBA			
	CSA Class 1** 25mm ice (350/450/550 Pa)	Round: 10/-- Flat: 7/--	Round: TBA Flat: TBA	Round: 21/-- Flat: 15/--	Round: TBA Flat: TBA			
	CSA Class 3** 25mm ice (350/450/550 Pa)	Round: 32/12-- Flat: 21/8--	Round: TBA Flat: TBA	Round: 21/-- Flat: 15/--	Round: TBA Flat: TBA			
Shipping Dimensions (LxWxH*)		133x96x54	133x96x54	133x96x55	133x96x55			
Shipping Weight (lbs)		11,384	11,431	12,196	12,243			

\*Assumptions: Projected areas (PA) shown are bare; a 1-5 multiplier used for iced area; loads centrally located and balanced at tower top; considers step-pegs, safety cable, and one 1/2" tx line per 10 sq.ft.; "--" indicates tower failure. \*\* For examples of CSA Class 1 vs Class 3, see page 28.

For more SuperTITAN Accessories and Replacement Parts, see pages 61 to 76.

# 190' Towers



Model Designation:		S300	S310				
Part Number:		5.94.0300.190	5.94.0310.190				
<p>Due to the weight, towers on this page are not available in pre-assembled 10' sections. They ship in "knock-down" format and require field assembly by experienced, professional, tower installers.</p> <p>Trylon Distributors will stock individual 10', knock-down sections, therefore customers may choose to order towers by the section (see pages 58 and 59), rather than a complete tower kit. Ordering by section also facilitates choosing a different foundation/anchorage system versus the anchor bolts and base feet supplied in kit format.</p> <p>For example, to order the 190' S300, one can use the kit number 5.94.0300.190. Alternatively, one could order sections #3 Top, #4, #5, etc.</p> <p>Models S300 and S310 include all 10' sections, base feet and tie-rods, splice hardware, and angle frame brackets to support a top antenna mounting pipe (pipe sold separately on page 70).</p>							
Allowable antenna area in ft <sup>2</sup> at*	CSA Class 1** 10mm ice (350/450/550 Pa)	Round: 10/-- Flat: 7/--	Round: TBA Flat: TBA				
	CSA Class 1** 25mm ice (350/450/550 Pa)	Round: 10/-- Flat: 7/--	Round: TBA Flat: TBA				
	CSA Class 3** 25mm ice (350/450/550 Pa)	Round: 30/12-- Flat: 20/8--	Round: TBA Flat: TBA				
Shipping Dimensions (L"xW"xH")		133x96x55	133x96x55				
Shipping Weight (lbs)		12,405	12,452				



\*Assumptions: Projected areas (PA) shown are bare; a 1-5 multiplier used for iced area; loads centrally located and balanced at tower top; considers step-pegs, safety cable, and one 1/2" tx line per 10 sq.ft.; "--" indicates tower failure. \*\* For examples of CSA Class 1 vs Class 3, see page 28.

For more SuperTITAN Accessories and Replacement Parts, see pages 61 to 76.



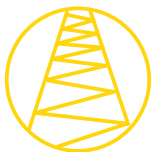

# SUPER TITAN™ KD Individual Tower Sections

## Knocked-Down Regular Sections # 2 - #21

Part Number	Description	Ship Wt. (lbs)	Ship LxWxH (in)	Image
5.94.0021.000	Knocked-down SuperTITAN Regular section # 2	192	122x12x14	 <p>Section #14 5.94.0141.000</p>
5.94.0031.000	Knocked-down SuperTITAN Regular section # 3	192	122x12x14	
5.94.0041.000	Knocked-down SuperTITAN Regular section # 4	198	122x12x14	
5.94.0051.000	Knocked-down SuperTITAN Regular section # 5	201	122x12x14	
5.94.0061.000	Knocked-down SuperTITAN Regular section # 6	263	122x12x14	
5.94.0071.000	Knocked-down SuperTITAN Regular section # 7	298	122x12x14	
5.94.0081.000	Knocked-down SuperTITAN Regular section # 8	302	122x12x14	
5.94.0091.000	Knocked-down SuperTITAN Regular section # 9	305	122x12x14	
5.94.0101.000	Knocked-down SuperTITAN Regular section #10	338	122x12x14	
5.94.0111.000	Knocked-down SuperTITAN Regular section #11	344	122x12x14	
5.94.0121.000	Knocked-down SuperTITAN Regular section #12	349	122x12x14	
5.94.0101.OHD	Knocked-down SuperTITAN Heavy Duty section #10HD (5/16" thk legs)	417	122x12x14	
5.94.0111.OHD	Knocked-down SuperTITAN Heavy Duty section #11HD (5/16" thk legs)	523	122x12x14	
5.94.0121.OHD	Knocked-down SuperTITAN Heavy Duty section #12HD (5/16" thk legs)	530	122x12x14	
5.94.0131.000	Knocked-down SuperTITAN Regular section #13	920	122x12x14	
5.94.0141.000	Knocked-down SuperTITAN Regular section #14	758	122x12x14	
5.94.0151.000	Knocked-down SuperTITAN Regular section #15	774	122x12x14	
5.94.0161.000	Knocked-down SuperTITAN Regular section #16	792	122x12x14	
5.94.0171.000	Knocked-down SuperTITAN Regular section #17	857	122x12x14	
5.94.0181.000	Knocked-down SuperTITAN Regular section #18	960	122x12x14	
5.94.0191.000	Knocked-down SuperTITAN Regular section #19	983	122x12x14	
5.94.0201.000	Knocked-down SuperTITAN Regular section #20	1006	122x12x14	
5.94.0211.000	Knocked-down SuperTITAN Regular section #21	1030	122x12x14	

## Knocked-Down Top Sections # 1 - #12HD (pipe not included)

Part Number	Description	Ship Wt. (lbs)	Ship LxWxH (in)	Image
5.94.0012.000	Knocked-down SuperTITAN Top section # 1	224	122x40x14	
5.94.0022.000	Knocked-down SuperTITAN Top section # 2	234	122x40x14	
5.94.0032.000	Knocked-down SuperTITAN Top section # 3	244	122x40x14	
5.94.0042.000	Knocked-down SuperTITAN Top section # 4	254	122x40x14	
5.94.0052.000	Knocked-down SuperTITAN Top section # 5	264	122x40x14	
5.94.0062.000	Knocked-down SuperTITAN Top section # 6	333	122x40x14	
5.94.0072.000	Knocked-down SuperTITAN Top section # 7	373	122x40x14	
5.94.0082.000	Knocked-down SuperTITAN Top section # 8	403	122x40x14	
5.94.0092.000	Knocked-down SuperTITAN Top section # 9	408	122x40x14	
5.94.0102.000	Knocked-down SuperTITAN Top section #10	437	122x40x14	
5.94.0102.OHD	Knocked-down SuperTITAN Top section #10HD section (5/16" thk legs)	519	122x40x14	
5.94.0112.OHD	Knocked-down SuperTITAN Top section #11 HD section (5/16" thk legs)	554	122x40x14	
5.94.0122.OHD	Knocked-down SuperTITAN Top section #12 HD section (5/16" thk legs)	558	122x40x14	

# Individual Tower sections



Assembled Regular Sections # 2 - #12HD				
Part Number	Description	Ship Wt. (lbs)	Ship LxWxH (in)	Image
5.95.0021.000	Assembled # 2 SuperTITAN Regular section	216	133x40x24	
5.95.0031.000	Assembled # 3 SuperTITAN Regular section	219	133x40x27	
5.95.0041.000	Assembled # 4 SuperTITAN Regular section	223	133x40x30	
5.95.0051.000	Assembled # 5 SuperTITAN Regular section	229	133x40x33	
5.95.0061.000	Assembled # 6 SuperTITAN Regular section	285	133x40x37	
5.95.0071.000	Assembled # 7 SuperTITAN Regular section	321	133x40x40	
5.95.0081.000	Assembled # 8 SuperTITAN Regular section	325	133x40x43	
5.95.0091.000	Assembled # 9 SuperTITAN Regular section	328	133x40x47	
5.95.0101.000	Assembled #10 SuperTITAN Regular section	337	133x40x50	
5.95.0101.0HD	Assembled #10 SuperTITAN Heavy Duty section (5/16" thk legs)	417	133x40x48	
5.95.0111.000	Assembled #11 SuperTITAN Regular section	368	133x48x53	
5.95.0111.0HD	Assembled #11 SuperTITAN Heavy Duty section (5/16" thk legs)	469	133x48x53	
5.95.0121.000	Assembled #12 SuperTITAN Regular section	372	133x48x53	
5.95.0121.0HD	Assembled #12 SuperTITAN Heavy Duty section (5/16" thk legs)	473	133x48x53	

Assembled Top Sections #1 - #10 (pipe not included)				
Part Number	Description	Ship Wt. (lbs)	Ship LxWxH (in)	Image
5.95.0012.000	Assembled SuperTITAN Top section # 1	250	133x40x18	
5.95.0022.000	Assembled SuperTITAN Top section # 2	252	133x40x21	
5.95.0032.000	Assembled SuperTITAN Top section # 3	261	133x40x27	
5.95.0042.000	Assembled SuperTITAN Top section # 4	270	133x40x30	
5.95.0052.000	Assembled SuperTITAN Top section # 5	277	133x40x33	
5.95.0062.000	Assembled SuperTITAN Top section # 6	342	133x40x37	
5.95.0072.000	Assembled SuperTITAN Top section # 7	388	133x40x40	
5.95.0082.000	Assembled SuperTITAN Top section # 8	423	133x48x40	
5.95.0092.000	Assembled SuperTITAN Top section # 9	428	133x48x40	
5.95.0102.000	Assembled SuperTITAN Top section #10	435	133x48x40	

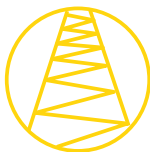

### Anchor Kits for Concrete Foundations

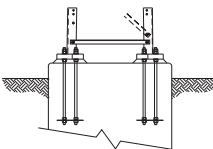
Part Number	Description	Ship Wt. (lbs)	Ship LxWxH (in)	Image	
5.81.0202.000	5' Foundation section 2F - fits section # 1	111	60x40x8	 <p>5' Foundation section</p>	
5.81.0203.000	5' Foundation section 3F - fits section # 2	114	60x40x8		
5.81.0204.000	5' Foundation section 4F - fits section # 3	117	60x40x8		
5.81.0205.000	5' Foundation section 5F - fits section # 4	120	60x40x8		
5.81.0206.000	5' Foundation section 6F - fits section # 5	150	60x40x8		
5.81.0207.000	5' Foundation section 7F - fits section # 6	167	60x40x8		
5.81.0208.000	5' Foundation section 8F - fits section # 7	169	60x40x8		
5.81.0209.000	5' Foundation section 9F - fits section # 8	178	60x48x8		
5.81.0210.000	5' Foundation section 10F - fits section # 9	182	60x48x8		
5.81.0211.000	5' Foundation section 11F - fits section #10	235	60x48x8		
5.81.0212.000	5' Foundation section 12F - fits section #11	301	60x48x8		
5.81.0212.0HD	5' Foundation section 12HDF - fits section #11HD	378	60x48x8		
5.81.0213.000	5' Foundation section 13F - fits section #12	311	60x51x8		
5.81.0213.0HD	5' Foundation section 13HDF - fits section #12HD	325	60x40x8		
4.79.0000.015	Base Feet and Tie-rod Kit - fits section #14	715	84x22x26		 <p>Base Feet and Tie-rod Kit</p>
4.79.0000.016	Base Feet and Tie-rod Kit - fits section #15	722	84x22x26		
4.79.0000.017	Base Feet and Tie-rod Kit - fits section #16	730	95x22x26		
4.79.0000.018	Base Feet and Tie-rod Kit - fits section #17	737	107x22x26		
4.79.0000.019	Base Feet and Tie-rod Kit - fits section #18	766	120x22x26		
4.79.0000.020	Base Feet and Tie-rod Kit - fits section #19	787	84x22x26		
4.79.0000.021	Base Feet and Tie-rod Kit - fits section #20	794	84x22x26		
4.79.0000.022	Base Feet and Tie-rod Kit - fits section #21	802	84x22x26		

## P.Eng. Stamped Drawings

### P.E. Stamped Drawings

Part Number	Description	Ship Wt. (lbs)	Image
4.77.0101.200*	P.Eng. Stamped Dwg: Tower profile & standard FDN	2	
4.77.0101.400**	P.Eng. Stamped Dwg: Special soil FDN analysis & design	2	
4.77.0101.600**	P.Eng. Stamped Dwg: Tower profile & special soil FDN design	2	

\* To order this P.Eng. stamped drawing, a completed Tower Loading Questionnaire must accompany your PO to Trylon's Distributor. Questions include: maximum design wind speed, radial ice accumulation, projected antenna area in sq. ft., etc. To download questionnaire, go to [www.trylon.com](http://www.trylon.com) and follow links: Canada - Light Duty Towers - SuperTITAN - Sizing/TowerCalc - Option 2.

\*\* This requires an official geotechnical soils report to be submitted along with the purchase order for this special foundation design/analysis. PO will not be accepted without geotechnical soils report for the site in question.

\*\*\* To order this package, you must submit a site-specific geotechnical soils report along with your tower loading questionnaire and PO.

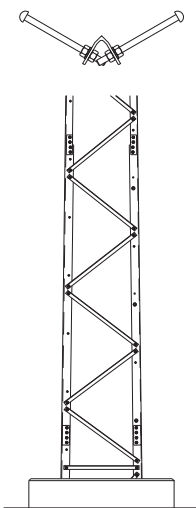
Step-Bolt Climbing Kits			
Part Number	Description	Ship Wt. (lbs)	Image
4.98.0100.010	Step-Bolt Kit for 10' SuperTITAN section (leg mounted & screw-in)	12	
4.98.0100.020	Step-Bolt Kit for 20' SuperTITAN Tower (leg mounted & screw-in)	24	
4.98.0100.030	Step-Bolt Kit for 30' SuperTITAN Tower (leg mounted & screw-in)	36	
4.98.0100.040	Step-Bolt Kit for 40' SuperTITAN Tower (leg mounted & screw-in)	48	
4.98.0100.050	Step-Bolt Kit for 50' SuperTITAN Tower (leg mounted & screw-in)	60	
4.98.0100.060	Step-Bolt Kit for 60' SuperTITAN Tower (leg mounted & screw-in)	72	
4.98.0100.070	Step-Bolt Kit for 70' SuperTITAN Tower (leg mounted & screw-in)	84	
4.98.0100.080	Step-Bolt Kit for 80' SuperTITAN Tower (leg mounted & screw-in)	96	
4.98.0100.090	Step-Bolt Kit for 90' SuperTITAN Tower (leg mounted & screw-in)	108	
4.98.0100.100	Step-Bolt Kit for 100' SuperTITAN Tower (leg mounted & screw-in)	120	
4.98.0100.110	Step-Bolt Kit for 110' SuperTITAN Tower (leg mounted & screw-in)	132	
4.98.0100.120	Step-Bolt Kit for 120' SuperTITAN Tower (leg mounted & screw-in)	144	
4.98.0200.010	Welded Step-Peg Ladder, 10' long (STSS sect #13 - #21 only)	40	
4.98.0200.020	Welded, Base (bot) Step-Peg Ladder, 23-1/6" long (STSS sect #13 - #21)	10	
4.98.1000.050	Step-Bolt Kit for 50' S1000 (2 welded sect & 3 screw-in)	236	
4.98.1100.050	Step-Bolt Kit for 50' S1100 (3 welded sect & 2 screw-in)	274	
4.98.1200.050	Step-Bolt Kit for 50' S1200 (4 welded sect & 1 screw-in)	312	
4.98.S900.060	Step-Bolt Kit for 60' S900 (2 welded sect & 4 screw-in)	248	
4.98.1000.060	Step-Bolt Kit for 60' S1000 (3 welded sect & 3 screw-in)	286	
4.98.1100.060	Step-Bolt Kit for 60' S1100 (4 welded sect & 2 screw-in)	336	
4.98.S800.070	Step-Bolt Kit for 70' S800 (2 welded sect & 5 screw-in)	260	
4.98.S900.070	Step-Bolt Kit for 70' S900 (3 welded sect & 4 screw-in)	298	
4.98.1000.070	Step-Bolt Kit for 70' S1000 (4 welded sect & 3 screw-in)	336	
4.98.1100.070	Step-Bolt Kit for 70' S1100 (5 welded sect & 2 screw-in)	386	
4.98.S700.080	Step-Bolt Kit for 80' S700 (2 welded sect & 6 screw-in)	272	
4.98.S800.080	Step-Bolt Kit for 80' S800 (3 welded sect & 5 screw-in)	310	
4.98.S900.080	Step-Bolt Kit for 80' S900 (4 welded sect & 4 screw-in)	348	
4.98.1000.080	Step-Bolt Kit for 80' S1000 (5 welded sect & 3 screw-in)	386	
4.98.1100.080	Step-Bolt Kit for 80' S1100 (6 welded sect & 2 screw-in)	412	
4.98.S600.090	Step-Bolt Kit for 90' S600 (2 welded sect & 7 screw-in)	284	
4.98.S800.090	Step-Bolt Kit for 90' S800 (4 welded sect & 5 screw-in)	360	
4.98.S900.090	Step-Bolt Kit for 90' S900 (5 welded sect & 4 screw-in)	398	
4.98.1000.090	Step-Bolt Kit for 90' S1000 (6 welded sect & 3 screw-in)	436	
4.98.1100.090	Step-Bolt Kit for 90' S1100 (7 welded sect & 2 screw-in)	474	
4.98.S500.100	Step-Bolt Kit for 100' S500 (2 welded sect & 8 screw-in)	296	
4.98.S600.100	Step-Bolt Kit for 100' S600 (3 welded sect & 7 screw-in)	334	
4.98.S700.100	Step-Bolt Kit for 100' S700 (4 welded sect & 6 screw-in)	372	
4.98.S800.100	Step-Bolt Kit for 100' S800 (5 welded sect & 5 screw-in)	410	
4.98.S900.100	Step-Bolt Kit for 100' S900 (6 welded sect & 4 screw-in)	448	
4.98.1000.100	Step-Bolt Kit for 100' S1000 (7 welded sect & 3 screw-in)	486	
4.98.1100.100	Step-Bolt Kit for 100' S1100 (8 welded sect & 2 screw-in)	524	
4.98.S400.110	Step-Bolt Kit for 110' S400 (2 welded sect & 9 screw-in)	308	
4.98.S500.110	Step-Bolt Kit for 110' S500 (3 welded sect & 8 screw-in)	346	

Leg mounted & Screw-In Bolts used on sections # 1-12HD





Welded Sections used on sections #13-21



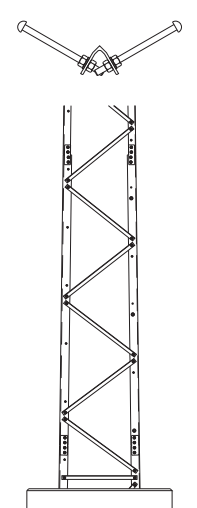

# SUPER TITAN™ KD Accessories – Climbing Step-Bolts

## Step-Bolt Climbing Kits continued

Part Number	Description	Ship Wt. (lbs)	Image	
4.98.S600.110	Step-Bolt Kit for 110' S600 (4 welded sect & 7 screw-in)	384	 <p>Leg mounted &amp; Screw-In Bolts used on sections # 1-12HD</p>	
4.98.S700.110	Step-Bolt Kit for 110' S700 (5 welded sect & 6 screw-in)	422		
4.98.S800.110	Step-Bolt Kit for 110' S800 (6 welded sect & 5 screw-in)	460		
4.98.S900.110	Step-Bolt Kit for 110' S900 (7 welded sect & 4 screw-in)	498		
4.98.1000.110	Step-Bolt Kit for 110' S1000 (8 welded sect & 3 screw-in)	536		
4.98.1100.110	Step-Bolt Kit for 110' S1100 (9 welded sect & 2 screw-in)	574		
4.98.S300.120	Step-Bolt Kit for 120' S300 (2 welded sect & 10 screw-in)	320		
4.98.S400.120	Step-Bolt Kit for 120' S400 (3 welded sect & 9 screw-in)	358		
4.98.S500.120	Step-Bolt Kit for 120' S500 (4 welded sect & 8 screw-in)	396		
4.98.S600.120	Step-Bolt Kit for 120' S600 (5 welded sect & 7 screw-in)	434		
4.98.S700.120	Step-Bolt Kit for 120' S700 (6 welded sect & 6 screw-in)	472		
4.98.S800.120	Step-Bolt Kit for 120' S800 (7 welded sect & 5 screw-in)	510		
4.98.S900.120	Step-Bolt Kit for 120' S900 (8 welded sect & 4 screw-in)	548		
4.98.1000.120	Step-Bolt Kit for 120' S1000 (9 welded sect & 3 screw-in)	586		
4.98.S300.130	Step-Bolt Kit for 130' S300 (3 welded sect & 10 screw-in)	370		
4.98.S400.130	Step-Bolt Kit for 130' S400 (4 welded sect & 9 screw-in)	408		
4.98.S500.130	Step-Bolt Kit for 130' S500 (5 welded sect & 8 screw-in)	446		
4.98.S600.130	Step-Bolt Kit for 130' S600 (6 welded sect & 7 screw-in)	484		
4.98.S700.130	Step-Bolt Kit for 130' S700 (7 welded sect & 6 screw-in)	522		
4.98.S800.130	Step-Bolt Kit for 130' S800 (8 welded sect & 5 screw-in)	560		
4.98.S900.130	Step-Bolt Kit for 130' S900 (9 welded sect & 4 screw-in)	598		
4.98.S300.140	Step-Bolt Kit for 140' S300 (4 welded sect & 10 screw-in)	420		
4.98.S400.140	Step-Bolt Kit for 140' S400 (5 welded sect & 9 screw-in)	458		
4.98.S500.140	Step-Bolt Kit for 140' S500 (6 welded sect & 8 screw-in)	496		
4.98.S600.140	Step-Bolt Kit for 140' S600 (7 welded sect & 7 screw-in)	534		
4.98.S700.140	Step-Bolt Kit for 140' S700 (8 welded sect & 6 screw-in)	572		
4.98.S800.140	Step-Bolt Kit for 140' S800 (9 welded sect & 5 screw-in)	610		
4.98.S300.150	Step-Bolt Kit for 150' S300 (5 welded sect & 10 screw-in)	470		 <p>Welded Sections used on sections #13-21</p>
4.98.S400.150	Step-Bolt Kit for 150' S400 (6 welded sect & 9 screw-in)	508		
4.98.S500.150	Step-Bolt Kit for 150' S500 (7 welded sect & 8 screw-in)	546		
4.98.S600.150	Step-Bolt Kit for 150' S600 (8 welded sect & 7 screw-in)	584		
4.98.S700.150	Step-Bolt Kit for 150' S700 (9 welded sect & 6 screw-in)	622		
4.98.S300.160	Step-Bolt Kit for 160' S300 (6 welded sect & 10 screw-in)	520		
4.98.S400.160	Step-Bolt Kit for 160' S400 (7 welded sect & 9 screw-in)	558		
4.98.S500.160	Step-Bolt Kit for 160' S500 (8 welded sect & 8 screw-in)	596		
4.98.S600.160	Step-Bolt Kit for 160' S600 (9 welded sect & 7 screw-in)	634		
4.98.S300.170	Step-Bolt Kit for 170' S300 (7 welded sect & 10 screw-in)	570		
4.98.S400.170	Step-Bolt Kit for 170' S400 (8 welded sect & 9 screw-in)	608		
4.98.S500.170	Step-Bolt Kit for 170' S500 (9 welded sect & 8 screw-in)	646		
4.98.S300.180	Step-Bolt Kit for 180' S300 (8 welded sect & 10 screw-in)	620		
4.98.S400.180	Step-Bolt Kit for 180' S400 (9 welded sect & 9 screw-in)	658		
4.98.S300.190	Step-Bolt Kit for 190' S300 (9 welded sect & 10 screw-in)	670		

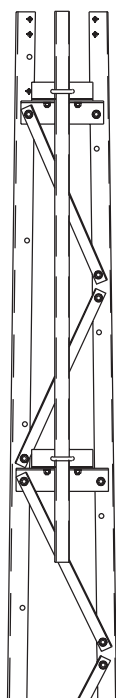

Antenna Face Mount Kits (6' long pipe in a variety of diameters)			
Part Number	Description	Ship Wt. (lbs)	Image
4.84.0001.001	Antenna Face Mount Kit - fits section # 1, 1.9"OD pipe	30	
4.84.0001.002	Antenna Face Mount Kit - fits section # 2, 1.9"OD pipe	30	
4.84.0001.003	Antenna Face Mount Kit - fits section # 3, 1.9"OD pipe	30	
4.84.0001.004	Antenna Face Mount Kit - fits section # 4, 1.9"OD pipe	35	
4.84.0001.005	Antenna Face Mount Kit - fits section # 5, 1.9"OD pipe	35	
4.84.0001.006	Antenna Face Mount Kit - fits section # 6, 1.9"OD pipe	40	
4.84.0001.007	Antenna Face Mount Kit - fits section # 7, 1.9"OD pipe	40	
4.84.0001.008	Antenna Face Mount Kit - fits section # 8, 1.9"OD pipe	45	
4.84.0001.009	Antenna Face Mount Kit - fits section # 9, 1.9"OD pipe	48	
4.84.0001.010	Antenna Face Mount Kit - fits section #10, 1.9"OD pipe	53	
4.84.0001.011	Antenna Face Mount Kit - fits section #11, 1.9"OD pipe	58	
4.84.0001.012	Antenna Face Mount Kit - fits section #12, 1.9"OD pipe	70	
4.84.0002.005	# 5 Face Mount Kit with 2 3/8"OD x 6' long pipe	140	
4.84.0002.006	# 6 Face Mount Kit with 2 3/8"OD x 6' long pipe	145	
4.84.0002.007	# 7 Face Mount Kit with 2 3/8"OD x 6' long pipe	150	
4.84.0006.001	SuperTITAN Antenna Face Mount Kit - fits section # 1, 4.5"OD pipe	90	
4.84.0006.002	SuperTITAN Antenna Face Mount Kit - fits section # 2, 4.5"OD pipe	92	
4.84.0006.003	SuperTITAN Antenna Face Mount Kit - fits section # 3, 4.5"OD pipe	94	
4.84.0006.004	SuperTITAN Antenna Face Mount Kit - fits section # 4, 4.5"OD pipe	95	
4.84.0006.005	SuperTITAN Antenna Face Mount Kit - fits section # 5, 4.5"OD pipe	97	
4.84.0006.006	SuperTITAN Antenna Face Mount Kit - fits section # 6, 4.5"OD pipe	99	
4.84.0006.007	SuperTITAN Antenna Face Mount Kit - fits section # 7, 4.5"OD pipe	102	
4.84.0006.008	SuperTITAN Antenna Face Mount Kit - fits section # 8, 4.5"OD pipe	103	
4.84.0006.009	SuperTITAN Antenna Face Mount Kit - fits section # 9, 4.5"OD pipe	104	
4.84.0006.010	SuperTITAN Antenna Face Mount Kit - fits section #10, 4.5"OD pipe	106	
4.84.0006.011	SuperTITAN Antenna Face Mount Kit - fits section #11, 4.5"OD pipe	108	
4.84.0006.012	SuperTITAN Antenna Face Mount Kit - fits section #12, 4.5"OD pipe	110	

Antenna Face Mount Kits (10' long pipe)			
Part Number	Description	Ship Wt. (lbs)	Image
4.84.0002.105	# 5 Face Mount Kit w/ 2 3/8"OD x 10' pipe, adjusts for tower taper	175	
4.84.0002.106	# 6 Face Mount Kit w/ 2 3/8"OD x 10' pipe, adjusts for tower taper	180	

Universal Face Mounts			
Part Number	Description	Ship Wt. (lbs)	Image
4.84.0002.301	Antenna Face Mount w/ 2 3/8"x 6' pipe - fits section # 1 to 3	47	
4.84.0002.302	Antenna Face Mount w/ 2 3/8"x 6' pipe - fits section # 3 to 7	53	
4.84.0002.303	Antenna Face Mount w/ 2 3/8"x 6' pipe - fits section # 7 to 9	57	

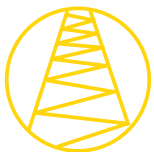

## Antenna Leg Mounts (fit all SuperTITAN legs; accomodates tower taper)

Part Number	Description	Ship Wt. (lbs)	Image
4.84.2702.215	Antenna Leg Mount c/w 1.9"OD x 6' pipe	120	
4.84.2702.220	Antenna Leg Mount c/w 2.375"OD x 6' pipe	130	
4.84.2702.225	Antenna Leg Mount c/w 2.875"OD x 6' pipe	140	
4.84.2702.230	Antenna Leg Mount c/w 3.5"OD x 6' pipe	150	
4.84.2702.235	Antenna Leg Mount c/w 4"OD x 6' pipe	160	

## Cluster Antenna Mounts

Part Number	Description	Ship Wt. (lbs)	Image
4.84.3CLS.00A	3-cluster Antenna Mount, 1.66" OD tube	40	<p>3-cluster Antenna Mount</p> <p>6-cluster Antenna Mount</p>
4.84.6CLS.00A	6-cluster Antenna Mount, 1.66" OD tube	80	

## Light Stand-Off Antenna Mounts

Part Number	Description	Ship Wt. (lbs)	Image
5.930.0202.002	2' Stand-Off with Small Backing Kits – follows tower taper	42	
5.930.0202.022	2' Stand-Off with Universal Backing Kits – adjusts for tower taper	56	
5.930.0203.002	3' Stand-Off with Small Backing Kits – follows tower taper	46	
5.930.0203.022	3' Stand-Off with Universal Backing Kits – adjusts for tower taper	48	
5.930.0205.022	5' Stand-Off with Universal Backing Kits – adjusts for tower taper	87	
5.930.0205.002	5' Stand-Off with Small Backing Kits – follows tower taper	78	
5.930.0206.002	6' Stand-Off with Small Backing Kits – follows tower taper	87	

Note: The additional projected area created by the mounts themselves must be taken into consideration for wind load considerations. The offset distance must also be considered.

Camera Mount (for top of tower)				
Part Number	Description	Ship Wt. (lbs)	Ship LxWxH (in)	Image
4.85.0102.000	SuperTITAN Camera Mount - surveillance	28	60x12x12	

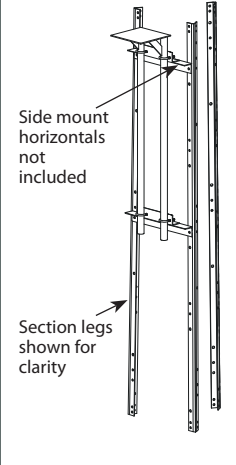
Camera Mount (for side mounting below the tower top)				
Part Number	Description	Ship Wt. (lbs)	Ship LxWxH (in)	Image
4.85.0103.001	SuperTITAN Camera Side Mount - surveillance	65	60x12x12	

Factory Painted Towers - Orange & White, Water-Based (applied by spray gun in factory; kit includes extra paint for touch-ups)	
Paint pricing available upon request, please call Trylon for details - 519.669.5421 or email info@trylon.com.	
	

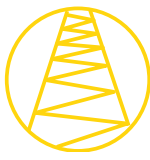

**Base Feet Kits less Anchor Bolts** (includes base feet, horizontal support brace, and positioning template)

Part Number	Description	Ship Wt. (lbs)	Image
4.79.0000.304	Base Feet, 3-Pak, no anchors - fits SuperTITAN section #3	160	
4.79.0000.305	Base Feet, 3-Pak, no anchors - fits SuperTITAN section #4	160	
4.79.0000.306	Base Feet, 3-Pak, no anchors - fits SuperTITAN section #5	198	
4.79.0000.307	Base Feet, 3-Pak, no anchors - fits SuperTITAN section #6	215	
4.79.0000.308	Base Feet, 3-Pak, no anchors - fits SuperTITAN section #7	215	
4.79.0000.309	Base Feet, 3-Pak, no anchors - fits SuperTITAN section #8	215	
4.79.0000.310	Base Feet, 3-Pak, no anchors - fits SuperTITAN section #9	215	
4.79.0000.311	Base Feet, 3-Pak, no anchors - fits SuperTITAN section #10	230	
4.79.0000.312	Base Feet, 3-Pak, no anchors - fits SuperTITAN section #11	230	
4.79.0000.312HD	Base Feet, 3-Pak, no anchors - fits SuperTITAN section #11HD	240	
4.79.0000.313	Base Feet, 3-Pak, no anchors - fits SuperTITAN section #12	230	
4.79.0000.313HD	Base Feet, 3-Pak, no anchors - fits SuperTITAN section #12HD	240	
4.79.0000.315	Base Feet, 3-Pak, no anchors - fits SuperTITAN section #14	770	
4.79.0000.316	Base Feet, 3-Pak, no anchors - fits SuperTITAN section #15	770	
4.79.0000.317	Base Feet, 3-Pak, no anchors - fits SuperTITAN section #16	770	
4.79.0000.318	Base Feet, 3-Pak, no anchors - fits SuperTITAN section #17	770	
4.79.0000.319	Base Feet, 3-Pak, no anchors - fits SuperTITAN section #18	800	
4.79.0000.320	Base Feet, 3-Pak, no anchors - fits SuperTITAN section #19	800	
4.79.0000.321	Base Feet, 3-Pak, no anchors - fits SuperTITAN section #20	800	
4.79.0000.322	Base Feet, 3-Pak, no anchors - fits SuperTITAN section #21	800	

**Base Feet Kit with Rock Bolts** (includes template for anchors, keyhole plate)

Part Number	Description	Ship Wt. (lbs)	Image
4.79.0000.104	Base Feet Kit with 5/8" x 98" Rock Bolts - fits SuperTITAN # 3	266	
4.79.0000.105	Base Feet Kit with 5/8" x 98" Rock Bolts - fits SuperTITAN # 4	266	
4.79.0000.106	Base Feet Kit with 7/8" x 122" Rock Bolts - fits SuperTITAN # 5	400	
4.79.0000.107	Base Feet Kit with 7/8" x 122" Rock Bolts - fits SuperTITAN # 6	425	
4.79.0000.108	Base Feet Kit with 7/8" x 122" Rock Bolts - fits SuperTITAN # 7	425	
4.79.0000.109	Base Feet Kit with 7/8" x 122" Rock Bolts - fits SuperTITAN # 8	425	
4.79.0000.110	Base Feet Kit with 7/8" x 122" Rock Bolts - fits SuperTITAN # 9	430	
4.79.0000.111	Base Feet Kit with 7/8" x 122" Rock Bolts - fits SuperTITAN #10	470	
4.79.0000.112	Base Feet Kit with 7/8" x 122" Rock Bolts - fits SuperTITAN #11	470	
4.79.0000.112HD	Base Feet Kit with 7/8" x 122" Rock Bolts - fits SuperTITAN #11HD	480	
4.79.0000.113	Base Feet Kit with 7/8" x 122" Rock Bolts - fits SuperTITAN #12	475	
4.79.0000.113HD	Base Feet Kit with 7/8" x 122" Rock Bolts - fits SuperTITAN #12HD	485	
4.79.0000.115	Base Feet Kit with 1" x 128" Rock Bolts - fits SuperTITAN #14	1,015	
4.79.0000.116	Base Feet Kit with 1" x 128" Rock Bolts - fits SuperTITAN #15	1,020	
4.79.0000.117	Base Feet Kit with 1" x 128" Rock Bolts - fits SuperTITAN #16	1,020	
4.79.0000.118	Base Feet Kit with 1" x 128" Rock Bolts - fits SuperTITAN #17	1,020	
4.79.0000.119	Base Feet Kit with 1" x 128" Rock Bolts - fits SuperTITAN #18	1,050	
4.79.0000.120	Base Feet Kit with 1" x 128" Rock Bolts - fits SuperTITAN #19	1,050	
4.79.0000.121	Base Feet Kit with 1" x 128" Rock Bolts - fits SuperTITAN #20	1,050	
4.79.0000.122	Base Feet Kit with 1" x 128" Rock Bolts - fits SuperTITAN #21	1,050	

Note: Rock bolts above are suitable provided the following rock conditions exist:

- 1) Rock quality – RQD 90% or better
- 2) Rock unit weight – 180 pcf
- 3) Exposed rock at surface (max 6" of earth cover)

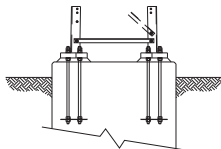
<b>Base Feet Kit with Tie-rods</b> (alternative to 5' embedment section - for new concrete pours)			
Part Number	Description	Ship Wt. (lbs)	Image
4.79.0000.004	Base Feet Kit with 5/8" x 30" Anchor Bolts - fits SuperTITAN # 3	156	
4.79.0000.005	Base Feet Kit with 5/8" x 30" Anchor Bolts - fits SuperTITAN # 4	160	
4.79.0000.006	Base Feet Kit with 7/8" x 30" Anchor Bolts - fits SuperTITAN # 5	198	
4.79.0000.007	Base Feet Kit with 7/8" x 30" Anchor Bolts - fits SuperTITAN # 6	228	
4.79.0000.008	Base Feet Kit with 7/8" x 30" Anchor Bolts - fits SuperTITAN # 7	232	
4.79.0000.009	Base Feet Kit with 7/8" x 30" Anchor Bolts - fits SuperTITAN # 8	230	
4.79.0000.010	Base Feet Kit with 7/8" x 30" Anchor Bolts - fits SuperTITAN # 9	232	
4.79.0000.011	Base Feet Kit with 7/8" x 30" Anchor Bolts - fits SuperTITAN #10	238	
4.79.0000.012	Base Feet Kit with 7/8" x 30" Anchor Bolts - fits SuperTITAN #11	238	
4.79.0000.012HD	Base Feet Kit with 7/8" x 30" Anchor Bolts - fits SuperTITAN #11HD	250	
4.79.0000.013	Base Feet Kit with 7/8" x 30" Anchor Bolts - fits SuperTITAN #12	238	
4.79.0000.013HD	Base Feet Kit with 7/8" x 30" Anchor Bolts - fits SuperTITAN #12HD	250	
4.79.0000.015	Base Feet Kit with Anchor Bolts - fits SuperTITAN #14 sect	702	
4.79.0000.016	Base Feet Kit with Anchor Bolts - fits SuperTITAN #15 sect	710	
4.79.0000.017	Base Feet Kit with Anchor Bolts - fits SuperTITAN #16 sect	717	
4.79.0000.018	Base Feet Kit with Anchor Bolts - fits SuperTITAN #17 sect	724	
4.79.0000.019	Base Feet Kit with Anchor Bolts - fits SuperTITAN #18 sect	753	
4.79.0000.020	Base Feet Kit with Anchor Bolts - fits SuperTITAN #19 sect	775	
4.79.0000.021	Base Feet Kit with Anchor Bolts - fits SuperTITAN #20 sect	782	
4.79.0000.022	Base Feet Kit with Anchor Bolts - fits SuperTITAN #21 sect	789	

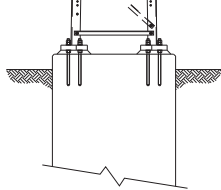
<b>Base Feet Kit with Hilti Bolts</b> (includes pouches of adhesive compound for grouting in anchor bolts - for existing concrete pads and roofs)			
Part Number	Description	Ship Wt. (lbs)	Image
4.79.0000.204	Base Feet Kit with 5/8" x 15" Hilti Bolts - fits SuperTITAN # 3	110	
4.79.0000.205	Base Feet Kit with 5/8" x 15" Hilti Bolts - fits SuperTITAN # 4	113	
4.79.0000.206	Base Feet Kit with 7/8" x 20" Hilti Bolts - fits SuperTITAN # 5	153	
4.79.0000.207	Base Feet Kit with 7/8" x 24" Hilti Bolts - fits SuperTITAN # 6	187	
4.79.0000.208	Base Feet Kit with 7/8" x 24" Hilti Bolts - fits SuperTITAN # 7	192	
4.79.0000.209	Base Feet Kit with 7/8" x 24" Hilti Bolts - fits SuperTITAN # 8	195	
4.79.0000.210	Base Feet Kit with 7/8" x 24" Hilti Bolts - fits SuperTITAN # 9	197	
4.79.0000.211	Base Feet Kit with 7/8" x 24" Hilti Bolts - fits SuperTITAN #10	201	
4.79.0000.212	Base Feet Kit with 7/8" x 24" Hilti Bolts - fits SuperTITAN #11	200	
4.79.0000.212HD	Base Feet Kit with 7/8" x 24" Hilti Bolts - fits SuperTITAN #11HD	210	
4.79.0000.213	Base Feet Kit with 7/8" x 24" Hilti Bolts - fits SuperTITAN #12	201	
4.79.0000.213HD	Base Feet Kit with 7/8" x 24" Hilti Bolts - fits SuperTITAN #12HD	211	
4.79.0000.215	Base Feet Kit with 1" x 30" Hilti Bolts - fits SuperTITAN #14	790	
4.79.0000.216	Base Feet Kit with 1" x 30" Hilti Bolts - fits SuperTITAN #15	800	
4.79.0000.217	Base Feet Kit with 1" x 30" Hilti Bolts - fits SuperTITAN #16	800	
4.79.0000.218	Base Feet Kit with 1" x 30" Hilti Bolts - fits SuperTITAN #17	800	
4.79.0000.219	Base Feet Kit with 1" x 30" Hilti Bolts - fits SuperTITAN #18	800	
4.79.0000.220	Base Feet Kit with 1" x 30" Hilti Bolts - fits SuperTITAN #19	845	
4.79.0000.221	Base Feet Kit with 1" x 30" Hilti Bolts - fits SuperTITAN #20	845	
4.79.0000.222	Base Feet Kit with 1" x 30" Hilti Bolts - fits SuperTITAN #21	845	

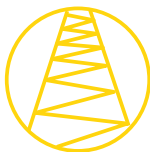

### Basic Light Kit (dual obstruction red lights, non-alarmed, steady burning, no photocell, c/w lights, cable, connectors, ty wraps, etc.)

Part Number	Description	Ship Wt. (lbs)*	Image
4.93.0200.150	Basic DOL Light Kit, 0 to 150' towers	60	
<p>* Packaging includes three pieces: one box with lights only (20"L x 8"W x 10"H), one reel of tech cable (24"OD x 12"H), and one box of all other components (8"L x 8"W x 16"H).</p>			

### Light Kit with Photocell (non-alarmed, c/w red lights, cable, connectors, ty wraps, etc.)

Part Number	Description	Ship Wt. (lbs)	Image
4.93.STPH.150	0-150' DOL Light Kit	90	
4.93.STPH.190	160-190' Beacon Light Kit	130	

### Light Kit with Alarmed Controller and Photocell (c/w red lights, cable, connectors, ty wraps, etc.)

Part Number	Description	Ship Wt. (lbs)	Image
4.93.STAL.150	0-150' DOL Light Kit	100	
4.93.STAL.190	160-190' Beacon Light Kit	140	

### White Strobe Light Kit (medium intensity, c/w cable, connectors, etc., no mid DOL)

Part Number	Description	Ship Wt. (lbs)	Image
4.93.STWS.100	SuperTITAN White Strobe Kit, 0 to 100' towers	145	
4.93.STWS.190	SuperTITAN White Strobe Kit, 101' to 190' towers	160	

### 48VDC LED Light Kit with Photocell (ideal for sites powered by solar energy)

Part Number	Description	Ship Wt. (lbs)	Image
4.93.LED1.150	0'-150' LED dual obstruction light kit, photocell, no SOL	150	
4.93.LED1.200	160'-190' LED beacon light kit, photocell, two LED SOL	180	

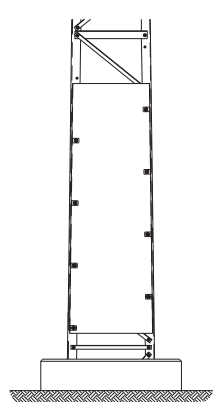
Anti-Climb Shield Kits			
Part Number	Description	Ship Wt. (lbs)	Image
4.92.0001.002	Anti-Climb Shield Kit - SuperTITAN section # 2	100	
4.92.0001.003	Anti-Climb Shield Kit - SuperTITAN section # 3	110	
4.92.0001.004	Anti-Climb Shield Kit - SuperTITAN section # 4	122	
4.92.0001.005	Anti-Climb Shield Kit - SuperTITAN section # 5	133	
4.92.0001.006	Anti-Climb Shield Kit - SuperTITAN section # 6	145	
4.92.0001.007	Anti-Climb Shield Kit - SuperTITAN section # 7	160	
4.92.0001.008	Anti-Climb Shield Kit - SuperTITAN section # 8	172	
4.92.0001.009	Anti-Climb Shield Kit - SuperTITAN section # 9	185	
4.92.0001.010	Anti-Climb Shield Kit - SuperTITAN section #10	197	
4.92.0001.011	Anti-Climb Shield Kit - SuperTITAN section #11 & #11HD	208	
4.92.0001.012	Anti-Climb Shield Kit - SuperTITAN section #12 & #12HD	225	
4.92.0001.213	Anti-Climb Mesh - SuperTITAN sect. #13 to #21 (1 leg w/ step-bolt) Note: This does not cover the entire tower face, it only prevents access to the step-bolt ladder on one leg.	242	

Note: Please see page 77 for Anti-Climb Shield Kit installation.

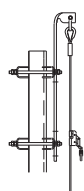
Cable Safety Climb Kits			
Part Number	Description	Ship Wt. (lbs)	Image
4.99.0485.050	Cable Safety Climb Kit (no slider): up to 50' SuperTITAN towers	85	
4.99.0485.100	Cable Safety Climb Kit (no slider): 60' to 100' SuperTITAN towers	110	
4.99.0485.150	Cable Safety Climb Kit (no slider): 110' to 150' SuperTITAN towers	130	
4.99.0485.190	Cable Safety Climb Kit (no slider): 160' to 190' SuperTITAN towers	147	
4.99.0101.001	Cougar Safety Cable Slider and Karabiner	4	

Note: Please visit [www.trylon.com](http://www.trylon.com) for full Safety Cable installation.

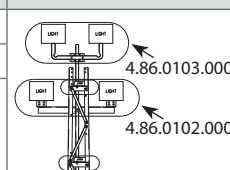
Flood Light Support Mounts			
Part Number	Description	Ship Wt. (lbs)	Image
4.86.0102.000	Dual Mount Angle Floodlight Support	12	
4.86.0103.000	Dual Mount Bullhorn Floodlight Support	40	

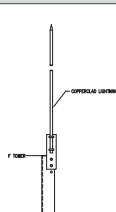
Lightning Rod			
Part Number	Description	Ship Wt. (lbs)	Image
4.90.0200.C05	SuperTITAN Lightning Rod, 5' long, copper-clad	20	

Safety Harness				
Part Number	Description	Ship Wt. (lbs)	Ship LxWxH (in)	Image
4.96.0100.000	Universal Safety Harness	5	16x16x8	

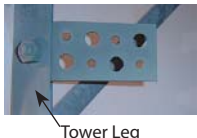

Mounting Pipes			
Part Number	Description	Ship Wt. (lbs)	Image
4.87.0101.000	1.9"OD x 6' Galvanized Tubing - 0.625"ID	14	
4.87.0101.100	1.9"OD x 8' Galvanized Tubing - 0.625"ID	18	
4.87.0101.200	1.9"OD x 10' Galvanized Tubing - 0.625"ID	23	
4.87.0101.300	1.9"OD x 12' Galvanized Tubing - 0.625"ID	28	
4.87.0102.000	2.375"OD x 6' Galvanized Tubing - 0.188" THK	28	
4.87.0102.100	2.375"OD x 8' Galvanized Tubing - 0.188" THK	37	
4.87.0102.200	2.375"OD x 10' Galvanized Tubing - 0.188" THK	46	
4.87.0102.300	2.375"OD x 12' Galvanized Tubing - 0.188" THK	55	
4.87.0102.400	2.375"OD x 20' Galvanized Tubing - 0.188" THK	92	
4.87.0103.000	2.875"OD Tubing - Mounting Pipe 6' galvanized	40	
4.87.0103.100	2.875"OD Tubing - Mounting Pipe 8' galvanized	45	
4.87.0103.200	2.875"OD Tubing - Mounting Pipe 10' galvanized	55	
4.87.0103.300	2.875"OD Tubing - Mounting Pipe 12' galvanized	65	
4.87.0103.400	2.875"OD Tubing - Mounting Pipe 20' galvanized	115	
4.87.0103.500	2.875"OD Tubing - Mounting Pipe 24' galvanized	130	
4.87.0104.101	4"OD x 6' Mounting Pipe - 0.25" THK, HDG	55	
4.87.0104.201	4"OD x 8' Mounting Pipe - 0.25" THK, HDG	65	
4.87.0104.301	4"OD x 10' Mounting Pipe - 0.25" THK, HDG	90	
4.87.0104.401	4"OD x 12' Mounting Pipe - 0.25" THK, HDG	110	
4.87.0104.501	4"OD x 20' Mounting Pipe - 0.25" THK, HDG	180	
4.87.0104.601	4"OD x 24' Mounting Pipe - 0.25" THK, HDG	220	
4.87.0104.400	4.5"OD x 6' Mounting Pipe - 0.25" THK, HDG	72	
4.87.0104.500	4.5"OD x 10' Mounting Pipe - 0.25" THK, HDG	120	
4.87.0104.600	4.5"OD x 12' Mounting Pipe - 0.25" THK, HDG	144	
4.87.0104.700	4.5"OD x 20' Mounting Pipe - 0.25" THK, HDG	240	
4.87.0104.800	4.5"OD x 24' Mounting Pipe - 0.25" THK, HDG	288	

Tx Transmission Line Brackets (for sections # 1 to 12HD order three pieces per section; for #13 to 21 order four pieces per section)			
Part Number	Description	Ship Wt. (lbs)	Image
4.84.0300.100	4 Line Tx Bracket (single pak) - 4 lines maximum	2	
4.84.0300.300	8 Line Tx Bracket (single pak) - for angle ladder #4.98.0300.010 only	2	

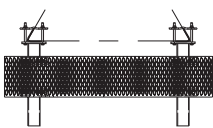
Work Platform			
Part Number	Description	Ship Wt. (lbs)	Image
4.88.0200.000	SuperTITAN Work Platform - fits sections # 1 to 12HD	89	

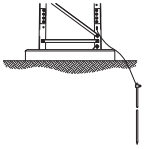

Tower Grounding Kit			
Part Number	Description	Ship Wt. (lbs)	Image
4.91.0103.000	SuperTITAN Basic Grounding Kit, 1 leg (# 1 to #12 only)	15	
4.91.0103.003	STSS EIA Compliant Grounding Kit, 3 leg (#13 to #21 only) Includes Tinned Copper Wire	65	

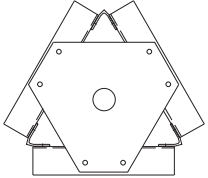
Rotor Plates (Rotor Plates are installed by attaching to Angle Frames - see below)			
Part Number	Description	Ship Wt. (lbs)	Image
4.89.0001.001	Upper Rotor Plates for SuperTITAN section # 1	14	
4.89.0001.002	Mid-level Rotor Plates for SuperTITAN section # 1	14	
4.89.0002.001	Upper Rotor Plates for SuperTITAN section # 2	16	
4.89.0002.002	Mid-level Rotor Plates for SuperTITAN section # 2	16	
4.89.0003.001	Upper Rotor Plates for SuperTITAN section # 3	17	
4.89.0003.002	Mid-level Rotor Plates for SuperTITAN section # 3	17	
4.89.0004.001	Upper Rotor Plates for SuperTITAN section # 4	18	
4.89.0004.002	Mid-level Rotor Plates for SuperTITAN section # 4	18	
4.89.0005.001	Upper Rotor Plates for SuperTITAN section # 5	19	
4.89.0005.002	Mid-level Rotor Plates for SuperTITAN section # 5	19	
4.89.0006.001	Upper Rotor Plates for SuperTITAN section # 6	20	
4.89.0006.002	Mid-level Rotor Plates for SuperTITAN section # 6	20	
4.89.0007.001	Upper Rotor Plates for SuperTITAN section # 7	21	
4.89.0007.002	Mid-level Rotor Plates for SuperTITAN section # 7	21	

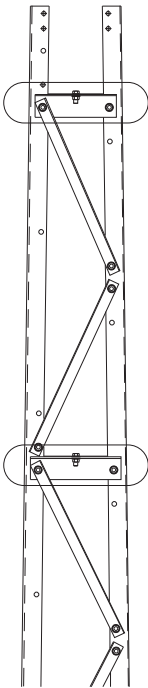
Pipe Mount Kits - Angle Frames (SuperTITAN Top Sections include one upper and one lower Angle Frame)			
Part Number	Description	Ship Wt. (lbs)	Image
4.83.0002.001	Upper Pipe Mount Kit for SuperTITAN section # 2	23	
4.83.0002.002	Lower Pipe Mount Kit for SuperTITAN section # 2	23	
4.83.0003.001	Upper Pipe Mount Kit for SuperTITAN section # 3	28	
4.83.0003.002	Lower Pipe Mount Kit for SuperTITAN section # 3	28	
4.83.0004.001	Upper Pipe Mount Kit for SuperTITAN section # 4	31	
4.83.0004.002	Lower Pipe Mount Kit for SuperTITAN section # 4	31	
4.83.0005.001	Upper Pipe Mount Kit for SuperTITAN section # 5	35	
4.83.0005.002	Lower Pipe Mount Kit for SuperTITAN section # 5	35	
4.83.0006.001	Upper Pipe Mount Kit for SuperTITAN section # 6	38	
4.83.0006.002	Lower Pipe Mount Kit for SuperTITAN section # 6	38	
4.83.0007.001	Upper Pipe Mount Kit for SuperTITAN section # 7	41	
4.83.0007.002	Lower Pipe Mount Kit for SuperTITAN section # 7	41	
4.83.0008.001	Upper Pipe Mount Kit for SuperTITAN section # 8	43	
4.83.0008.002	Lower Pipe Mount Kit for SuperTITAN section # 8	43	
4.83.0009.001	Upper Pipe Mount Kit for SuperTITAN section # 9	48	
4.83.0009.002	Lower Pipe Mount Kit for SuperTITAN section # 9	48	
4.83.0010.001	Upper Pipe Mount Kit for SuperTITAN section #10	51	
4.83.0010.002	Lower Pipe Mount Kit for SuperTITAN section #10	51	
4.83.0011.001	Upper Pipe Mount Kit for SuperTITAN section #11	53	
4.83.0011.002	Lower Pipe Mount Kit for SuperTITAN section #11	53	
4.83.0012.001	Upper Pipe Mount Kit for SuperTITAN section #12	58	
4.83.0012.002	Lower Pipe Mount Kit for SuperTITAN section #12	58	

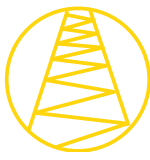

### Waveguide Bridge - 10' length (has twenty-four 7/16" holes and twenty 3/4" holes)

Part Number	Description	Ship Wt. (lbs)	Image
5.939.0112.001	One 18" x 10' Solid Cover c/w two 3-1/2" x 14' Direct Burial Posts and three 2-rung trapezes	403	<p>5.939.0112.001</p> <p>5.939.0113.001</p>
5.939.0113.001	One 18" x 10' Solid Cover c/w two 3-1/2" x 10-1/2' Base Shoe Posts and three 2-rung trapezes	385	

### Waveguide Bridge - 20' length (holds maximum 12 lines, assuming four bolt-on hangers are used)

Part Number	Description	Ship Wt. (lbs)	Image
5.939.0703.001	20' Bridge c/w 3 posts, 6 double trapezes	500	

### Waveguide Shield - 60" width (helps protect cables at end of bridge near flare)

Part Number	Description	Ship Wt. (lbs)	Image
5.939.0190.060	60" Waveguide Shield Assembly	52	

### External Climbing Ladder Kits (pre-kitted assemblies utilize both the Climbing Ladder Bracket kits in conjunction with our solid round ladders)

Part Number	Description	Ship Wt. (lbs)	Image
S/R Climbing Ladder Kits with Small Backing Assemblies (SBA) fits sections 1 - 12			<p>5.918.0110.001 10' S/R Ladder with three Small Backing Kits</p>
5.918.0105.001	5' S/R Ladder with 2 SBA kits	50	
5.918.0110.001	10' S/R Ladder with 3 SBA kits	89	
5.918.0115.001	15' S/R Ladder with 5 SBA kits	138	
5.918.0120.001	20' S/R Ladder with 6 SBA kits	177	<p>5.918.0110.002 10' S/R Ladder with three Large Backing Kits</p>
S/R Climbing Ladder Kits with Large Backing Assemblies (LBA) fits sections 13 - 21			
5.918.0105.002	5' S/R Ladder with 2 LBA kits	57	
5.918.0110.002	10' S/R Ladder with 3 LBA kits	99	
5.918.0115.002	15' S/R Ladder with 5 LBA kits	156	
5.918.0120.002	20' S/R Ladder with 6 LBA kits	198	

# Replacement Parts



<b>Splice Plates (individual quantities, not 3-paks, splice bolts not included)</b>			
Part Number	Description	Ship Wt. (lbs)	Image
3.924.0060.001	Outer Splice Plate - sections 18/19/20/21	5	<p>Filler Plate 3.924.01453.003</p>
3.924.0060.002	Inner Splice Plate - sections 18/19/20/21	5	
3.924.0151.001	Outer Splice Plate - sections 13/14/15/16/17	5	
3.924.0151.002	Inner Splice Plate - sections 13/14/15/16/17	3	
3.924.0152.001	Outer Splice Plate - sections # 1-2, 2-3, 3-4 and 4-5 (Qty 1)	3	
3.924.0152.002	Inner Splice Plate - sections # 1-2, 2-3, 3-4 and 4-5 (Qty 1)	2	
3.924.0153.001	Outer Splice Plate - section # 5-6	2	
3.924.0153.002	Inner Splice Plate - section # 5-6	1	
3.924.0153.003	Filler Plate - section # 5-6	3	
3.924.0154.001	Outer Splice Plate - section # 6-7	3	
3.924.0154.002	Inner Splice Plate - section # 6-7	2	
3.924.0155.001	Outer Splice Plate - sections # 7-8, 8-9 and 9-10 (Qty 1)	3	
3.924.0155.002	Inner Splice Plate - sections # 7-8, 8-9 and 9-10 (Qty 1)	2	
3.924.0156.001	Outer Splice Plate - section #10-11	3	
3.924.0156.002	Inner Splice Plate - section #10-11	2	
3.924.0157.001	Outer Splice Plate - sections #11-12 and 12-13F (Qty 1)	2	
3.924.0157.002	Inner Splice Plate - sections #11-12 and 12-13F (Qty 1)	2	
3.924.0177.001	Top Outer Splice Plate - section #13	4	
3.924.0177.002	Top Inner Splice Plate - section #13	4	

<b>Splice Bolts (for connecting section legs together)</b>			
Part Number	Description	Ship Wt. (lbs)	Image
5.1202021	1/2" x 1-1/2" A325 Bolt Assembly (20/pkg)	5	
5.1202022	1/2" x 1-3/4" A325 Bolt Assembly (20/pkg)	5	
5.1202024	1/2" x 2-1/4" A325 Bolt Assembly - HDG (20/pkg)	5	
5.1202043	5/8" x 2" A325 Bolt Assembly (20/pkg)	6	
5.1202044	5/8" x 2-1/4" A325 Bolt Assembly (20/pkg)	6	
5.1212061	3/8" x 2" x 2" Spacer 11/16" Hole - HDG (20/pkg)	2	
5.1202180	1/2" A563 DH Hex Nut - HDG (20/pkg)	2	
5.1202211	1/2" F-436 Flat Washer - HDG (20/pkg)	2	
5.1202212	5/8" F-436 Flat Washer - HDG (20/pkg)	2	

<b>Replacement Tower Legs</b>			
Part Number	Description	Ship Wt. (lbs)	Image
3.620.0001.001	Angle Leg for sections # 1/3/5	5	
3.620.0002.001	Angle Leg for sections # 2/4	5	
3.620.0003.001	Angle Leg for section # 6	6	
3.620.0004.001	Angle Leg for section # 7	7	
3.620.0005.001	Angle Leg for sections # 8/10	7	
3.620.0006.001	Angle Leg for section # 9	7	
3.620.0007.001	Angle Leg for section #11	8	
3.620.0008.001	Angle Leg for section #12	8	
3.620.0032.001	Angle Leg for section #11HD	10	
3.620.0033.001	Angle Leg for section #12HD	10	
3.620.0064.001	Angle Leg for sections #13/14/15/16/17	11	
3.620.0063.001	Angle Leg for sections #18/19/20/21	13	

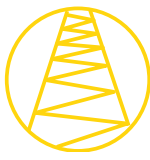

### Connection Plates

Part Number	Description	Ship Wt. (lbs)	Image
3.620.0067.001	Connection Plate (section #21)	47	
3.620.0067.002	Connection Plate (section #20)	44	
3.620.0067.003	Connection Plate (section #19)	42	
3.620.0067.004	Connection Plate (section #18)	40	
3.620.0068.001	Connection Plate (section #17)	34	
3.620.0068.002	Connection Plate (section #16)	35	
3.620.0068.003	Connection Plate (section #15)	32	
3.620.0068.004	Connection Plate (section #14)	30	
3.620.0068.005	Connection Plate (section #13)	30	

### 5' Foundation Section Components

Part Number	Description	Ship Wt. (lbs)
3.620.0009.001	Stub Leg for sections 2F/4F	16
3.620.0010.001	Stub Leg for sections 3F/5F	16
3.620.0011.001	Stub Leg for section 6F	25
3.620.0012.001	Stub Leg for sections 7F/9F	29
3.620.0013.001	Stub Leg for sections 8F/10F	29
3.620.0014.001	Stub Leg for section 11F	35
3.620.0015.001	Stub Leg for section 12F	33
3.620.0021.001	Stub Leg for section 13F	35
3.620.0035.001	Stub Leg for section 13HDF	43
3.620.0017.001	Diagonal 2F	4
3.620.0017.002	Diagonal 3F	4
3.620.0017.003	Diagonal 4F	4
3.620.0017.004	Diagonal 5F	4
3.620.0017.005	Diagonal 6F	5
3.620.0017.006	Diagonal 7F	5
3.620.0017.007	Diagonal 8F	5
3.620.0017.008	Diagonal 9F	5
3.620.0017.009	Diagonal 10F	5
3.620.0017.010	Diagonal 11F	6
3.620.0017.011	Diagonal 12F	6
3.620.0017.012	Diagonal 13F	6
3.620.0020.001	Top Horizontal 2F	4
3.620.0020.002	Top Horizontal 3F	5
3.620.0020.003	Top Horizontal 4F	6
3.620.0020.004	Top Horizontal 5F	7
3.620.0020.005	Top Horizontal 6F	8

### 5' Foundation Section Components (continued)

Part Number	Description	Ship Wt. (lbs)
3.620.0020.006	Top Horizontal 7F	9
3.620.0020.007	Top Horizontal 8F	10
3.620.0020.008	Top Horizontal 9F	11
3.620.0020.009	Top Horizontal 10F	11
3.620.0020.010	Top Horizontal 11F	13
3.620.0020.011	Top Horizontal 12F & 12HDF	13
3.620.0020.012	Top Horizontal 13F	14
3.620.0020.013	Bottom Horizontal 2F	9
3.620.0020.014	Bottom Horizontal 3F	11
3.620.0020.015	Bottom Horizontal 4F	13
3.620.0020.016	Bottom Horizontal 5F	14
3.620.0020.017	Bottom Horizontal 6F	16
3.620.0020.018	Bottom Horizontal 7F	18
3.620.0020.019	Bottom Outer Horizontal 8F	19
3.620.0020.020	Bottom Outer Horizontal 9F	21
3.620.0020.021	Bottom Outer Horizontal 10F	23
3.620.0020.022	Bottom Outer Horizontal 11F	26
3.620.0020.023	Bottom Outer Horizontal 12F & 12HDF	63
3.620.0020.024	Bottom Outer Horizontal 13F	67
3.620.0020.025	Bottom Inner Horizontal 8F	19
3.620.0020.026	Bottom Inner Horizontal 9F	21
3.620.0020.027	Bottom Inner Horizontal 10F	23
3.620.0020.028	Bottom Inner Horizontal 11F	26
3.620.0020.029	Bottom Inner Horizontal 12F & 12HDF	63
3.620.0020.030	Bottom Inner Horizontal 13F & 13HDF	67

# Replacement Parts



Replacement Diagonals Braces		
Part Number	Description	Ship Wt. (lbs)
3.620.0016.001	# 1 (section # 1)	8
3.620.0016.002	# 2 (section # 1)	8
3.620.0016.003	# 3 (section # 1)	8
3.620.0016.004	# 4 (section # 1)	8
3.620.0016.005	# 5 (section # 1)	8
3.620.0016.006	# 6 (section # 2)	8
3.620.0016.007	# 7 (section # 2)	9
3.620.0016.008	# 8 (section # 2)	9
3.620.0016.009	# 9 (section # 2)	9
3.620.0016.010	#10 (section # 2)	9
3.620.0016.011	#11 (section # 3)	9
3.620.0016.012	#12 (section # 3)	9
3.620.0016.013	#13 (section # 3)	9
3.620.0016.014	#14 (section # 3)	10
3.620.0016.015	#15 (section # 3)	10
3.620.0016.016	#16 (section # 4)	10
3.620.0016.017	#17 (section # 4)	10
3.620.0016.018	#18 (section # 4)	10
3.620.0016.019	#19 (section # 4)	10
3.620.0016.020	#20 (section # 4)	10
3.620.0016.021	#21 (section # 5)	11
3.620.0016.022	#22 (section # 5)	11
3.620.0016.023	#23 (section # 5)	11
3.620.0016.024	#24 (section # 5)	11
3.620.0016.025	#25 (section # 5)	11
3.620.0016.026	#26 (section # 6)	11
3.620.0016.027	#27 (section # 6)	11
3.620.0016.028	#28 (section # 6)	11
3.620.0016.029	#29 (section # 6)	11
3.620.0016.030	#30 (section # 6)	11
3.620.0016.031	#31 (section # 7)	11
3.620.0016.032	#32 (section # 7)	12
3.620.0016.033	#33 (section # 7)	12
3.620.0016.034	#34 (section # 7)	12
3.620.0016.035	#35 (section # 7)	12
3.620.0016.036	#36 (section # 8)	12

Replacement Diagonals Braces		
Part Number	Description	Ship Wt. (lbs)
3.620.0016.037	#37 (section # 8)	12
3.620.0016.038	#38 (section # 8)	13
3.620.0016.039	#39 (section # 8)	13
3.620.0016.040	#40 (section # 8)	13
3.620.0016.041	#41 (section # 9)	13
3.620.0016.042	#42 (section # 9)	13
3.620.0016.043	#43 (section # 9)	13
3.620.0016.044	#44 (section # 9)	14
3.620.0016.045	#45 (section # 9)	14
3.620.0016.046	#46 (section #10)	14
3.620.0016.047	#47 (section #10)	14
3.620.0016.048	#48 (section #10)	14
3.620.0016.049	#49 (section #10)	14
3.620.0016.050	#50 (section #10)	14
3.620.0016.051	#51H (section #11)	14
3.620.0016.052	#52H (section #11)	14
3.620.0016.053	#53H (section #11)	14
3.620.0016.054	#54H (section #11)	14
3.620.0016.055	#55H (section #11)	14
3.620.0016.056	#56H (section #12)	15
3.620.0016.057	#57H (section #12)	15
3.620.0016.058	#58H (section #12)	15
3.620.0016.059	#59H (section #12)	15
3.620.0016.060	#60H (section #12)	15
3.620.0065.001	Bottom Right (section #21)	3
3.620.0065.002	Top Right (section #21)	3
3.620.0065.003	Bottom Right (section #20)	3
3.620.0065.004	Top Right (section #20)	3
3.620.0065.005	Bottom Right (section #19)	3
3.620.0065.006	Top Right (section #19)	3
3.620.0065.007	Bottom Right (section #18)	3
3.620.0065.008	Top Right (section #18)	3
3.620.0065.009	Bottom Right (section #17)	3
3.620.0065.010	Top Right (section #17)	3
3.620.0065.011	Bottom Right (section #16)	3
3.620.0065.012	Top Right (section #16)	3



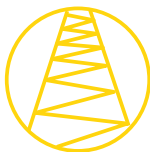

Replacement Diagonals Braces		
Part Number	Description	Ship Wt. (lbs)
3.620.0065.013	Bottom Right (section #15)	3
3.620.0065.014	Top Right (section #15)	3
3.620.0065.015	Bottom Right (section #14)	3
3.620.0065.016	Top Right (section #14)	3
3.620.0065.017	Bottom Right (section #13)	3
3.620.0065.018	Top Right (section #13)	3
3.620.0065.019	X Brace (section #13)	3
3.620.0065.101	Bottom Left (section #21)	3
3.620.0065.102	Top Left (section #21)	3
3.620.0065.103	Bottom Left (section #20)	3
3.620.0065.104	Top Left (section #20)	3
3.620.0065.105	Bottom Left (section #19)	3
3.620.0065.106	Top Left (section #19)	3
3.620.0065.107	Bottom Left (section #18)	3
3.620.0065.108	Top Left (section #18)	3
3.620.0065.109	Bottom Left (section #17)	3
3.620.0065.110	Top Left (section #17)	3
3.620.0065.111	Bottom Left (section #16)	3
3.620.0065.112	Top Left (section #16)	3
3.620.0065.113	Bottom Left (section #15)	3
3.620.0065.114	Top Left (section #15)	3
3.620.0065.115	Bottom Left (section #14)	3
3.620.0065.116	Top Left (section #14)	3
3.620.0065.117	Bottom Left (section #13)	3
3.620.0065.118	Top Left (section #13)	3
3.620.0066.001	Horizontal (section #21)	3
3.620.0066.002	Horizontal (section #20)	3
3.620.0066.003	Horizontal (section #19)	3
3.620.0066.004	Horizontal (section #18)	3
3.620.0066.005	Horizontal (section #17)	3
3.620.0066.006	Horizontal (section #16)	3
3.620.0066.007	Horizontal (section #15)	3
3.620.0066.008	Horizontal (section #14)	3
3.620.0066.009	Horizontal (section #13)	3
3.620.0066.010	Top Horizontal (section #13)	3

# Anti-Climb Panel Installation

(for sections # 1 to #12HD)



# SUPER TITAN<sup>™</sup> KD

KIT NUMBER	SECTION NUMBER	ANTI CLIMB SHIELD	MOUNTING CLIP 'A'	MOUNTING CLIP 'B'
4.92.0001.001	1	3.620.0053.001	3.620.0053.101	3.620.0053.101
4.92.0001.002	2	3.620.0053.002	3.620.0053.101	3.620.0053.101
4.92.0001.003	3	3.620.0053.003	3.620.0053.101	3.620.0053.101
4.92.0001.004	4	3.620.0053.004	3.620.0053.101	3.620.0053.101
4.92.0001.005	5	3.620.0053.005	3.620.0053.101	3.620.0053.104
4.92.0001.006	6	3.620.0053.006	3.620.0053.101	3.620.0053.102
4.92.0001.007	7	3.620.0053.007	3.620.0053.101	3.620.0053.101
4.92.0001.008	8	3.620.0053.008	3.620.0053.101	3.620.0053.101
4.92.0001.009	9	3.620.0053.009	3.620.0053.101	3.620.0053.101
4.92.0001.010	10	3.620.0053.010	3.620.0053.101	3.620.0053.103
4.92.0001.011	11	3.620.0053.011	3.620.0053.101	3.620.0053.101
4.92.0001.012	12	3.620.0053.012	3.620.0053.101	3.620.0053.101

5/8" x 1-3/4" A325 BOLT ASSY c/w ADD'L FLATWASHER (TYP)

ANTI CLIMB SHIELD

ANTI CLIMB SHIELD

#10 x 3/4" S.S. SELF TAPPING SCREW

SECTION A-A

Please email [info@trylon.com](mailto:info@trylon.com) for full installation details.

TOWER LEG

MOUNTING CLIP 'A' (7 LOCATIONS)

5/8" x 1-3/4" A325 BOLT ASSY c/w ADD'L FLATWASHER (TYP)

ANTI CLIMB SHIELD

MOUNTING CLIP 'B' (1 LOCATION)

10"

TOP OF CONCRETE

REV. BY:      CHK. BY:      DATE

DESCRIPTION

DATE

COMPANY HEREIN IS THE PROPERTY OF TRYLON MANUFACTURING COMPANY LTD. ALL DUPLICATION, RECORDING, DISCLOSURE OR USE IS PROHIBITED WITHOUT WRITTEN CONSENT OF TRYLON MANUFACTURING COMPANY LTD.

TRYLON TSF

CUSTOMER:      SITE:      SCALE: 20,000

DATE: 29 APR 03      BY: MAW      CHK: BCP      APP: JB

TITLE: ANTI CLIMB INSTALLATION      DRAWING NO. 000001.620.0044



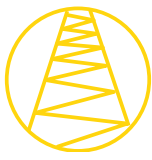

# SUPER TITAN™ K D Concrete Foundation Details

For towers with bottom sections # 2 to #12  
Including #11HD and #12HD  
(Normal dry soil)

Please email [info@trylon.com](mailto:info@trylon.com) for full foundation installation details, including foundation notes.

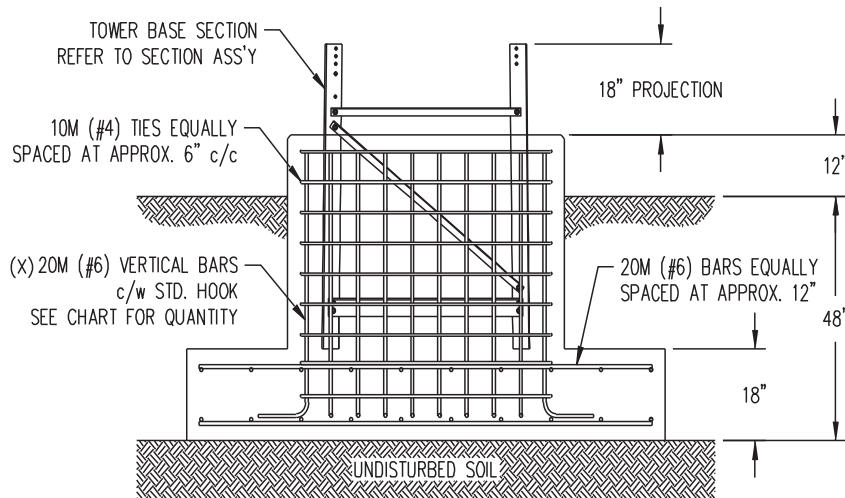
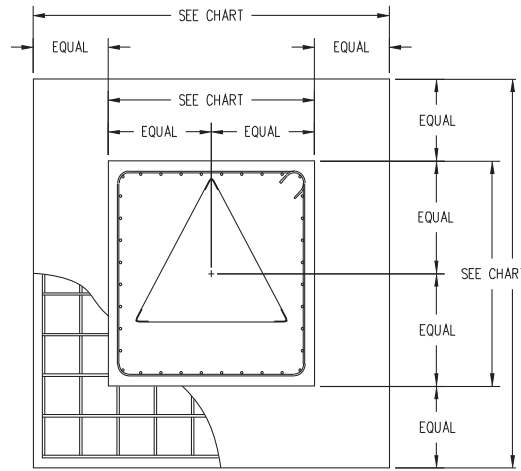

If Bottom Tower Section is:	Foundation Pad Size (ft.)	Pier Size (ft.)	Vertical Pier Bars (X)	Cubic Yards Concrete		
				Pad Concrete Volume	Pier Concrete Volume	Total Volume
#12	10'-6" x 10'-6"	5'-6" x 5'-6"	36	6.1	3.9	10.0
#11	10'-0" x 10'-0"	5'-6" x 5'-6"	36	5.6	3.9	9.5
#10	9'-6" x 9'-6"	5'-0" x 5'-0"	30	5.0	3.2	8.2
#9	9'-0" x 9'-0"	5'-0" x 5'-0"	30	4.5	3.2	7.7
#8	8'-6" x 8'-6"	4'-6" x 4'-6"	26	4.0	2.6	6.6
#7	7'-6" x 7'-6"	4'-6" x 4'-6"	26	3.1	2.6	5.7
#6	7'-0" x 7'-0"	4'-0" x 4'-0"	20	2.7	2.1	4.8
#5	6'-6" x 6'-6"	4'-0" x 4'-0"	20	2.4	2.1	4.5
#4	6'-6" x 6'-6"	4'-0" x 4'-0"	20	2.4	2.1	4.5
#3	6'-6" x 6'-6"	4'-0" x 4'-0"	20	2.4	2.1	4.5
#2	6'-0" x 6'-0"	4'-0" x 4'-0"	20	2.0	2.1	4.1

\* Includes Heavy Duty sections #11HD and #12HD.  
Notes: See [www.trylon.com](http://www.trylon.com) for important foundation and concrete notes.



For towers with bottom sections #13 to #21  
 Single-pad design with three piers  
 (Normal dry soil)

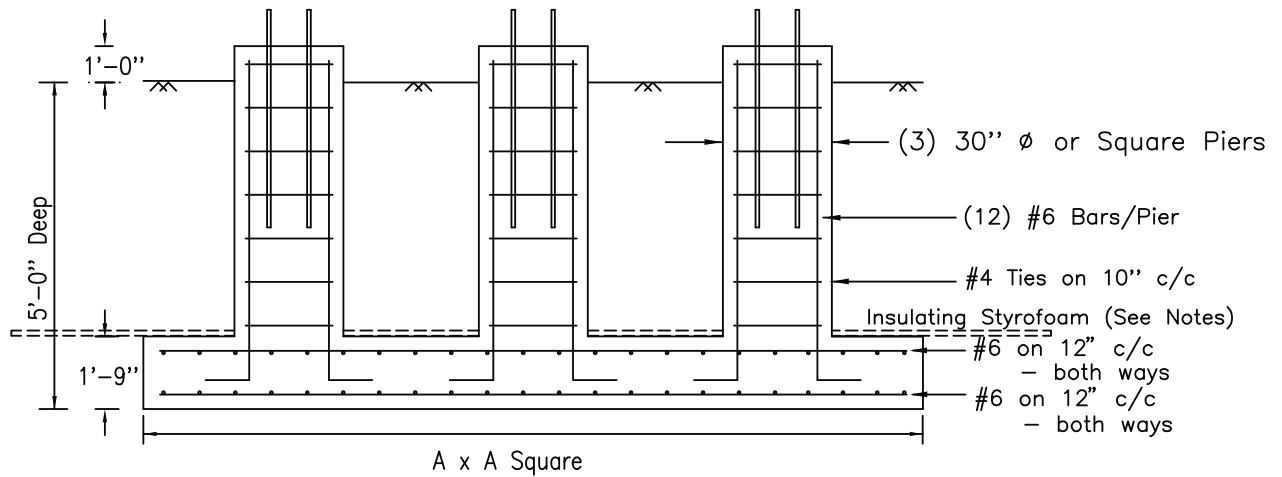

(0" Offset Tower Center to Foundation Center)

Round Pier		
Base Section #	A (ft)	Concrete Vol
#13	12'-0"	11.4
#14	12'-6"	12.2
#15	13'-6"	13.9
#16	14'-0"	14.7
#17	14'-6"	15.7
#18	15'-0"	16.6
#19	16'-0"	18.6
#20	17'-0"	20.8
#21	18'-0"	23.0

Please email [info@trylon.com](mailto:info@trylon.com) for full foundation installation details, including foundation notes.

**NOTES:**

Concrete volume in cubic yards.  
 Add 0.5 cubic yards to that shown for square piers.  
 Theoretical concrete volumes given. Add 10% to that given when ordering the concrete.

**FOUNDATION NOTES:**

**GENERAL:**

- 1) ALL WORKMANSHIP AND MATERIALS SHALL BE IN ACCORDANCE WITH APPLICABLE LOCAL STANDARDS.
- 2) FOUNDATIONS DESIGNED FOR NORMAL DRY SOIL CONDITIONS
- 3) THE TOWER BASE PAD SHALL BE PLACED AGAINST UNDISTURBED SOIL.

**CONCRETE:**

- 1) CONCRETE SHALL HAVE A MINIMUM COMPRESSIVE STRENGTH AT 28 DAYS OF NOT LESS THAN 4000 psi.
- 2) CONCRETE SHALL CONTAIN AN AIR ENTRAINING AGENT.
- 3) THE MAXIMUM SIZE OF COARSE AGGREGATE SHALL BE 3/4 in. SLUMP SHALL BE 3 in +/- 1 in
- 4) ALL GROUT SHALL BE NON-FERROUS AND NON SHRINK WITH A MINIMUM COMPRESSIVE STRENGTH OF 5000 psi AT 28 DAYS, EDGES GROUT SHALL BE TAPERED OFF AT 45°.

**REINFORCEMENT:**

- 1) ALL REINFORCEMENT SHALL HAVE A MINIMUM OF 3 in CONCRETE COVER.
- 2) REINFORCING STEEL SHALL BE DEFORMED BARS WITH A MINIMUM YIELD OF 60 ksi.

**BACKFILLING:**

- 1) BACKFILL SHALL BE PLACED IN THIN LIFTS (MAXIMUM 6 in) AND COMPACTED TO A MINIMUM OF 95 PERCENT OF STANDARD PROCTOR MAXIMUM DRY DENSITY. IN THE EVENT THAT EXCAVATED MATERIALS ARE NOT SUITABLE FOR BACKFILL, IT SHALL BE THE RESPONSIBILITY OF THE CONTRACTOR TO SUPPLY AND COMPACT SUITABLE CLEAN MATERIAL TO MEET THAT REQUIREMENT.

**INSULATION:**

- 1) WHERE FROST PENETRATION DEPTHS EXCEED 6 ft, PLACE INSULATING STRYFOAM ON SLAB EXTENDING 3 ft PAST THE EDGE OF THE SLAB. HIGHLOAD 40 INSULATION BY DOW CHEMICALS IS RECOMMENDED.



$\frac{EL. = 251.00'}{h-h = 2.50'}$   
 $\frac{EL. = 241.00'}{h-h = 2.76'}$   
 $\frac{EL. = 222.00'}{h-h = 3.25'}$   
 $\frac{EL. = 203.00'}{h-h = 3.75'}$   
 $\frac{EL. = 190.00'}{h-h = 4.00'}$   
 $\frac{EL. = 171.00'}{h-h = 6.00'}$   
 $\frac{EL. = 152.00'}{h-h = 8.00'}$   
 $\frac{EL. = 133.00'}{h-h = 10.00'}$   
 $\frac{EL. = 114.00'}{h-h = 12.00'}$   
 $\frac{EL. = 95.00'}{h-h = 14.00'}$   
 $\frac{EL. = 76.00'}{h-h = 16.00'}$   
 $\frac{EL. = 57.00'}{h-h = 18.00'}$   
 $\frac{EL. = 38.00'}{h-h = 20.00'}$   
 $\frac{EL. = 19.00'}{h-h = 22.00'}$   
 $\frac{EL. = 0'}{h-h = 24.00'}$

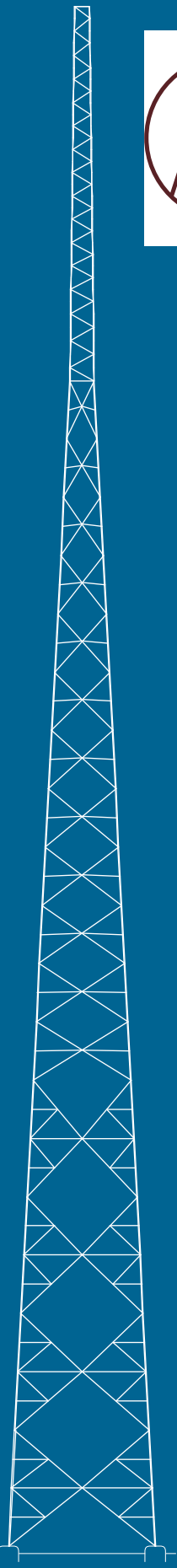

# SUPER TITAN<sup>TM</sup> MAX

- .. CSA compliant
- .. Ships directly from Tylon
- .. Ship knocked-down (unassembled) in 19' sections
- .. Max face width: 24 feet
- .. P.Eng. stamp available

# Tower Comparison

Trylon introduces a **new** member to the Stocked Product family and his name is MAX...

## SuperTitan MAX

Total Height: 96'  
Total Load: 15 sq ft\*



(\*70 mph Survival Wind Speed & 0" ice)

Total Height: 190'  
Total Load: 10 sq ft\*

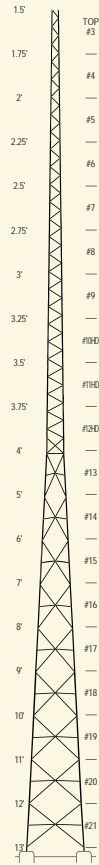

(\*350 Pa CSA S37-13 & 25 mm ice)

**MAX Height: 251'**  
**MAX Load: 92 sq ft\***

EL. = 251.00'  
h-h = 2.50'

EL. = 241.00'  
h-h = 2.76'

EL. = 222.00'  
h-h = 3.25'

EL. = 203.00'  
h-h = 3.75'

EL. = 190.00'  
h-h = 4.00'

EL. = 171.00'  
h-h = 6.00'

EL. = 152.00'  
h-h = 8.00'

EL. = 133.00'  
h-h = 10.00'

EL. = 114.00'  
h-h = 12.00'

EL. = 95.00'  
h-h = 14.00'

EL. = 76.00'  
h-h = 16.00'

EL. = 57.00'  
h-h = 18.00'

EL. = 38.00'  
h-h = 20.00'

EL. = 19.00'  
h-h = 22.00'

EL. = 0'  
h-h = 24.00'

(\*350 Pa CSA S37-13 & 25 mm ice)



- Survival tower
- Stocked and sold through distribution
- Ship assembled in 8' sections
- Max face width: 45 inches
- P.E. stamp **not** available
- Model shown: 96' T200

- CSA S37-13 compliant
- Stocked and sold through distribution
- Ship knocked-down (unassembled) in 10' sections
- Max face width: 13 feet
- P.E. stamp available
- Model shown: 190' S310

- CSA S37-13 compliant
- Ships directly from Trylon
- Ship knocked-down (unassembled) in 19' sections
- Max face width: 24 feet
- P.E. stamp available
- Model shown: 251' M300

SECTION DESIGNATION

EL. = 288.50'  
h-h = 1.50'  
EL. = 279.00'  
h-h = 1.75'

EL. = 260.00'  
h-h = 2.25'

EL. = 241.00'  
h-h = 2.75'

EL. = 222.00'  
h-h = 3.25'

EL. = 203.00'  
h-h = 3.75'

EL. = 190.00'  
h-h = 4.00'

EL. = 171.00'  
h-h = 6.00'

EL. = 152.00'  
h-h = 8.00'

EL. = 133.00'  
h-h = 10.00'

EL. = 114.00'  
h-h = 12.00'

EL. = 95.00'  
h-h = 14.00'

EL. = 76.00'  
h-h = 16.00'

EL. = 57.00'  
h-h = 18.00'

EL. = 38.00'  
h-h = 20.00'

EL. = 19.00'  
h-h = 22.00'

EL. = 0'  
h-h = 24.00'

EL. = 288.50'  
h-h = 1.50'  
EL. = 279.00'  
h-h = 1.75'

EL. = 269.50'  
h-h = 2.00'

EL. = 260.00'  
h-h = 2.25'

EL. = 250.50'  
h-h = 2.50'

EL. = 241.00'  
h-h = 2.75'

EL. = 231.50'  
h-h = 3.00'

EL. = 222.00'  
h-h = 3.25'

EL. = 212.50'  
h-h = 3.50'

EL. = 203.00'  
h-h = 3.75'

EL. = 203.00'  
h-h = 3.75'

HALF SECTIONS  
DESIGNATED M\*10

- M110
- M200
- M210
- M300
- M310
- M400
- M410
- M500
- M510
- M600

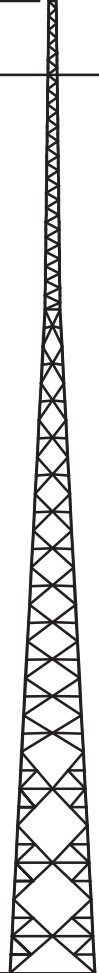
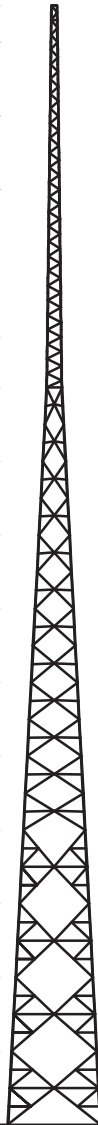





COMPLETE TOWER

COMPLETE SECTIONS  
DESIGNATED M\*00

251ft M110 - 24 (sq.ft)  
350Pa, 25mm  
CSA S37-13

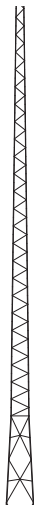
251ft M210 - 54 (sq.ft)  
350Pa, 25mm  
CSA S37-13

251ft M310 - 92 (sq.ft)  
350Pa, 25mm  
CSA S37-13

Model Designation:	M210	M310	M410	M510			
Part Number:	5.630.0210.099	5.630.0310.099	5.630.0410.099	5.630.0510.099			
	 #2 #3 #4 #5 #6 #7	 #3 #4 #5 #6 #7 #8	 #4 #5 #6 #7 #8 #9	 #5 #6 #7 #8 #9 #10			
Shipping Dimensions (L"xW"xH")	2 Bundles: 19'X10"x6" 2 Bundles: 19'x12"x8" 3 Bundles: 19'x15"x8" 1 Crate: 62"x20"x15"	2 Bundles: 19'X10"x6" 2 Bundles: 19'x12"x8" 3 Bundles: 19'x15"x8" 1 Crate: 62"x20"x15"	2 Bundles: 19'X10"x6" 2 Bundles: 19'x12"x8" 3 Bundles: 19'x15"x8" 1 Crate: 62"x20"x15"	2 Bundles: 19'X10"x6" 2 Bundles: 19'x12"x8" 3 Bundles: 19'x15"x8" 1 Crate: 62"x20"x15"			
Shipping Weight (lbs)	4,600	7,900	9,000	10,040			

\*Assumptions: Projected areas (PA) shown are bare; a 1.5 multiplier used for iced area; loads centrally located and balanced at tower top; considers step-pegs, safety cable, and one 1/2" tx line per 10 sq.ft.; "-" indicates tower failure.  
\*Round antennas include omnis, dipoles, dishes with radomes, etc. Antennas where wind hits a round surface. Flat Antennas include flat panels, dishes without radomes and cameras, where wind hits a flat surface.

## Common Accessories

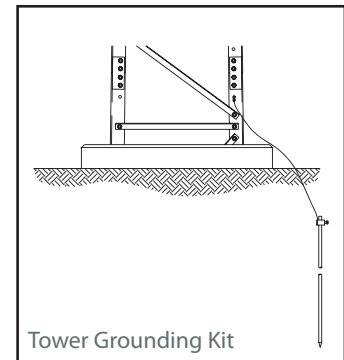

Accessory:	M210	M310	M410	M510		
<b>Cable Safety Climb Kits</b> <i>no slider</i>	4.99.0101.001	4.99.0101.001	4.99.0101.001	4.99.0101.001		
<b>Step-Bolt Kit</b> <i>leg mounted</i>	4.630.S210.099	4.630.S310.099	4.630.S410.099	4.630.S510.099		
<b>Anti-Climb Shield Kits</b>	4.630.0001.213	4.630.0001.213	4.630.0001.213	4.630.0001.213		
<b>Tower Grounding Kit</b> <i>basic, three leg</i>	4.91.0103.003	4.91.0103.003	4.91.0103.003	4.91.0103.003		

# 108' Towers



Model Designation:	M200	M300	M400	M500	M600		
Part Number:	5.630.0219.108	5.630.0319.108	5.630.0419.108	5.630.0519.108	5.630.0619.108		
Shipping Dimensions (L"xW"xH")	2 Bundles: 19'x10'x8" 2 Bundles: 19'x12'x8" 3 Bundles: 19'x15'x8" 1 Crate: 62'x20'x15"	2 Bundles: 19'x10'x8" 2 Bundles: 19'x12'x8" 3 Bundles: 19'x15'x8" 1 Crate: 62'x20'x15"	2 Bundles: 19'x10'x8" 2 Bundles: 19'x12'x8" 3 Bundles: 19'x15'x8" 1 Crate: 62'x20'x15"	2 Bundles: 19'x10'x8" 2 Bundles: 19'x12'x8" 3 Bundles: 19'x15'x8" 1 Crate: 62'x20'x15"	2 Bundles: 19'x10'x8" 2 Bundles: 19'x12'x8" 3 Bundles: 19'x15'x8" 1 Crate: 62'x20'x15"		
Shipping Weight (lbs)	5725	6755	7776	8730	9720		



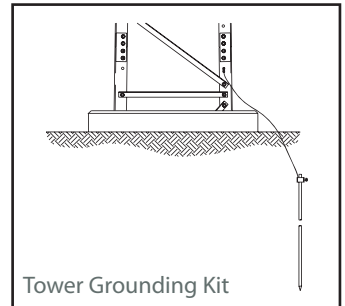

\*Assumptions: Projected areas (PA) shown are bare; a 1.5 multiplier used for iced area; loads centrally located and balanced at tower top; considers step-pegs, safety cable, and one 1/2" tx line per 10 sq.ft.; "-" indicates tower failure.  
\*Round antennas include omnis, dipoles, dishes with radomes, etc. Antennas where wind hits a round surface. Flat Antennas include flat panels, dishes without radomes and cameras, where wind hits a flat surface.

## Common Accessories

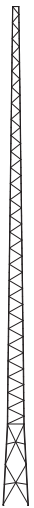

Accessory:	M200	M300	M400	M500	M600		
<b>Cable Safety Climb Kits</b> <i>no slider</i>	4.99.0495.150	4.99.0495.150	4.99.0495.150	4.99.0495.150	4.99.0495.150		
<b>Step-Bolt Kit</b> <i>leg mounted</i>	4.630.S200.108	4.630.S300.108	4.630.S400.108	4.630.S500.108	4.630.S600.108		
<b>Anti-Climb Shield Kits</b>	4.630.0001.213	4.630.0001.213	4.630.0001.213	4.630.0001.213	4.630.0001.213		
<b>Tower Grounding Kit</b> <i>basic, three leg</i>	4.91.0103.003	4.91.0103.003	4.91.0103.003	4.91.0103.003	4.91.0103.003		



Model Designation:		M110	M210	M310	M410	M510		
Part Number:		5.630.0110.118	5.630.0210.118	5.630.0310.118	5.630.0410.118	5.630.0510.118		
								
		#1 #2 #3 #4 #5 #6 #7	#2 #3 #4 #5 #6 #7 #8	#3 #4 #5 #6 #7 #8 #9	#4 #5 #6 #7 #8 #9 #10	#5 #6 #7 #8 #9 #10 #11		
Allowable antenna area in ft <sup>2</sup> *	CSA Class 1 350/450/550 Pa Wind 25mm ice	Round: 36/18/8 Flat: 24/12/5	Round: 80/52/38 Flat: 53/35/25	Round: 138/92/62 Flat: 92/61/41	Round: 154/114/88 Flat: 103/76/59	Round: 294/196/126 Flat: 196/131/84		
	CSA Class 3 350/450/550 Pa Wind 25mm ice	Round: 52/34/20 Flat: 35/23/13	Round: 114/78/54 Flat: 76/52/36	Round: 192/132/96 Flat: 128/88/64	Round: 198/148/118 Flat: 132/99/79	Round: 374/286/206 Flat: 249/191/137		
Shipping Dimensions (L"xW"xH")		2 Bundles: 19X10"x6" 2 Bundles: 19x12"x8" 3 Bundles: 19x15"x8" 1 Crate: 62"x20"x15"	2 Bundles: 19X10"x6" 2 Bundles: 19x12"x8" 3 Bundles: 19x15"x8" 1 Crate: 62"x20"x15"	2 Bundles: 19X10"x6" 2 Bundles: 19x12"x8" 3 Bundles: 19x15"x8" 1 Crate: 62"x20"x15"	2 Bundles: 19X10"x6" 2 Bundles: 19x12"x8" 3 Bundles: 19x15"x8" 1 Crate: 62"x20"x15"	2 Bundles: 19X10"x6" 2 Bundles: 19x12"x8" 3 Bundles: 19x15"x8" 1 Crate: 62"x20"x15"		
Shipping Weight (lbs)		5800	6900	7900	9000	10400		

\*Assumptions: Projected areas (PA) shown are bare; a 1.5 multiplier used for iced area; loads centrally located and balanced at tower top; considers step-pegs, safety cable, and one 1/2" tx line per 10 sq.ft.; "-" indicates tower failure.  
\*Round antennas include omnis, dipoles, dishes with radomes, etc. Antennas where wind hits a round surface. Flat Antennas include flat panels, dishes without radomes and cameras, where wind hits a flat surface.

## Common Accessories

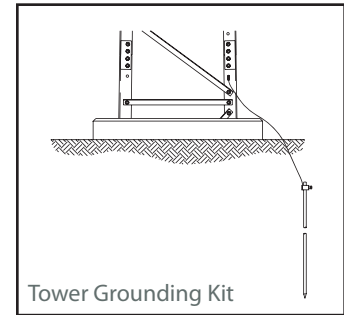





Accessory:	M110	M210	M310	M410	M510		
<b>Cable Safety Climb Kits</b> <i>no slider</i>	4.99.0495.150	4.99.0495.150	4.99.0495.150	4.99.0495.150	4.99.0495.150		
<b>Step-Bolt Kit</b> <i>leg mounted</i>	4.630.S110.118	4.630.S210.118	4.630.S310.118	4.630.S410.118	4.630.S510.118		
<b>Anti-Climb Shield Kits</b>	4.630.0001.213	4.630.0001.213	4.630.0001.213	4.630.0001.213	4.630.0001.213		
<b>Tower Grounding Kit</b> <i>basic, three leg</i>	4.91.0103.003	4.91.0103.003	4.91.0103.003	4.91.0103.003	4.91.0103.003		

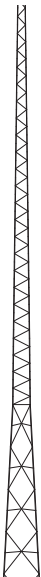

# 127' Towers



Model Designation:		M200	M300	M400	M500			
Part Number:		5.630.0219.127	5.630.0319.127	5.630.0419.127	5.630.0519.127			
								
		#2	#3	#4	#5			
		#3	#4	#5	#6			
		#4	#5	#6	#7			
		#5	#6	#7	#8			
		#6	#7	#8	#9			
		#7	#8	#9	#10			
		#8	#9	#10	#11			
Allowable antenna area in ft <sup>2</sup> *k	CSA Class 1 350/450/550 Pa Wind 25mm ice	Round: 52/32/20 Flat: 35/21/13	Round: 118/78/46 Flat: 79/52/31	Round: 142/100/58 Flat: 95/67/39	Round: 254/154/90 Flat: 169/103/60			
	CSA Class 3 350/450/550 Pa Wind 25mm ice	Round: 76/50/34 Flat: 51/33/23	Round: 160/114/82 Flat: 107/76/55	Round: 190/136/102 Flat: 127/91/58	Round: 366/242/162 Flat: 244/161/108			
Shipping Dimensions (L"xW"xH")		2 Bundles: 19'X10"x6" 2 Bundles: 19'x12"x8" 3 Bundles: 19'x15"x8" 1 Crate: 62"x20"x15"	2 Bundles: 19'X10"x6" 2 Bundles: 19'x12"x8" 3 Bundles: 19'x15"x8" 1 Crate: 62"x20"x15"	2 Bundles: 19'X10"x6" 2 Bundles: 19'x12"x8" 3 Bundles: 19'x15"x8" 1 Crate: 62"x20"x15"	2 Bundles: 19'X10"x6" 2 Bundles: 19'x12"x8" 3 Bundles: 19'x15"x8" 1 Crate: 62"x20"x15"			
Shipping Weight (lbs)		7100	8200	9300	10700			

\*Assumptions: Projected areas (PA) shown are bare; a 1.5 multiplier used for iced area; loads centrally located and balanced at tower top; considers step-pegs, safety cable, and one 1/2" tx line per 10 sq.ft.; "-" indicates tower failure.  
\*Round antennas include omnis, dipoles, dishes with radomes, etc. Antennas where wind hits a round surface. Flat Antennas include flat panels, dishes without radomes and cameras, where wind hits a flat surface.

## Common Accessories

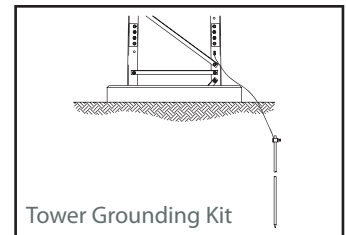
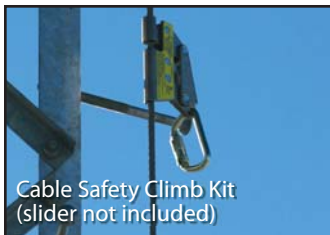

Accessory:	M200	M300	M400	M500			
<b>Cable Safety Climb Kits</b> <i>no slider</i>	4.99.0495.150	4.99.0495.150	4.99.0495.150	4.99.0495.150			
<b>Step-Bolt Kit</b> <i>leg mounted</i>	4.630.S200.127	4.630.S300.127	4.630.S400.127	4.630.S500.127			
<b>Anti-Climb Shield Kits</b>	4.630.0001.213	4.630.0001.213	4.630.0001.213	4.630.0001.213			
<b>Tower Grounding Kit</b> <i>basic, three leg</i>	4.91.0103.003	4.91.0103.003	4.91.0103.003	4.91.0103.003			

Model Designation:		M110	M210	M310	M410	M510		
Part Number:		5.630.0110.137	5.630.0210.137	5.630.0310.137	5.630.0410.137	5.630.0510.137		
Allowable antenna area in ft <sup>2</sup> *	CSA Class 1 350/450/550 Pa Wind 25mm ice	Round: 32/15/5 Flat: 21/11/4	Round: 76/50/30 Flat: 51/33/20	Round: 132/80/44 Flat: 88/53/29	Round: 148/110/58 Flat: 99/73/39	Round: 284/174/100 Flat: 189/116/67		
	CSA Class 3 350/450/550 Pa Wind 25mm ice	Round: 52/30/18 Flat: 35/20/12	Round: 108/74/52 Flat: 72/49/35	Round: 184/126/86 Flat: 123/84/57	Round: 192/144/112 Flat: 128/95/75	Round: 362/276/182 Flat: 241/84/121		
Shipping Dimensions (L"xW"xH")		2 Bundles: 19X10"x6" 2 Bundles: 19x12"x8" 3 Bundles: 19x15"x8" 1 Crate: 76"x25"x15"	2 Bundles: 19X10"x6" 2 Bundles: 19x12"x8" 3 Bundles: 19x15"x8" 1 Crate: 76"x25"x15"	2 Bundles: 19X10"x6" 2 Bundles: 19x12"x8" 3 Bundles: 19x15"x8" 1 Crate: 76"x25"x15"	2 Bundles: 19X10"x6" 2 Bundles: 19x12"x8" 3 Bundles: 19x15"x8" 1 Crate: 76"x25"x15"	2 Bundles: 19X10"x6" 2 Bundles: 19x12"x8" 3 Bundles: 19x15"x8" 1 Crate: 76"x25"x15"		
Shipping Weight (lbs)		7200	8300	9400	10900	12600		

\*Assumptions: Projected areas (PA) shown are bare; a 1.5 multiplier used for iced area; loads centrally located and balanced at tower top; considers step-pegs, safety cable, and one 1/2" tx line per 10 sq.ft.; "-" indicates tower failure.  
\*Round antennas include omnis, dipoles, dishes with radomes, etc. Antennas where wind hits a round surface. Flat Antennas include flat panels, dishes without radomes and cameras, where wind hits a flat surface.

## Common Accessories

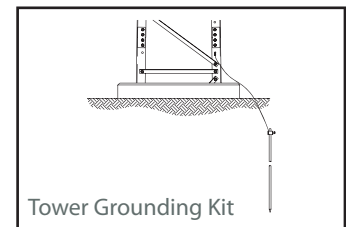
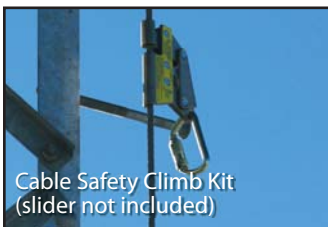

Accessory:	M110	M210	M310	M410	M510		
<b>Cable Safety Climb Kits</b> <i>no slider</i>	4.99.0495.150	4.99.0495.150	4.99.0495.150	4.99.0495.150	4.99.0495.150		
<b>Step-Bolt Kit</b> <i>leg mounted</i>	4.630.S110.137	4.630.S210.137	4.630.S310.137	4.630.S410.137	4.630.S510.137		
<b>Anti-Climb Shield Kits</b>	4.630.0001.213	4.630.0001.213	4.630.0001.213	4.630.0001.213	4.630.0001.213		
<b>Tower Grounding Kit</b> <i>basic, three leg</i>	4.91.0103.003	4.91.0103.003	4.91.0103.003	4.91.0103.003	4.91.0103.003		

# 146' Towers

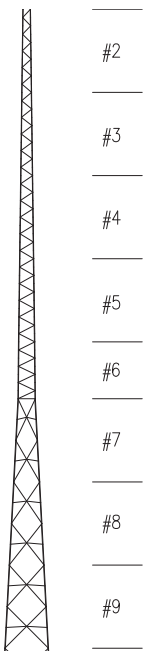
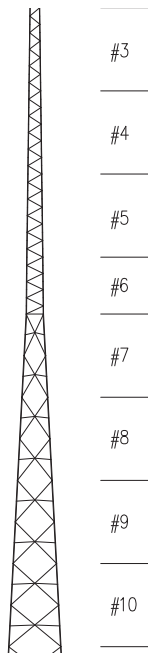
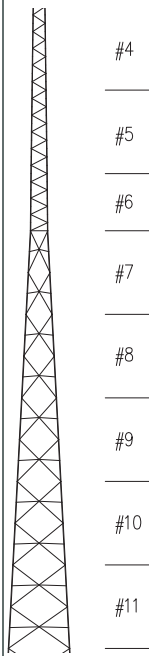
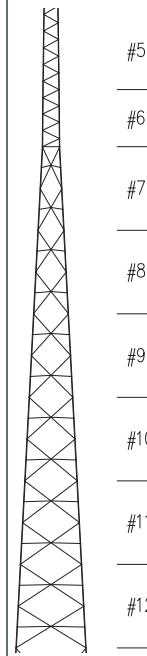
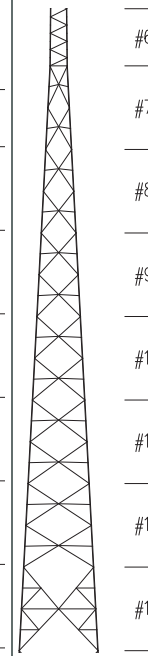

Model Designation:		M200	M300	M400	M500	M600		
Part Number:		5.630.0219.146	5.630.0319.146	5.630.0419.146	5.630.0519.146	5.630.0619.146		
								
		#2 #3 #4 #5 #6 #7 #8 #9	#3 #4 #5 #6 #7 #8 #9 #10	#4 #5 #6 #7 #8 #9 #10 #11	#5 #6 #7 #8 #9 #10 #11 #12	#6 #7 #8 #9 #10 #11 #12 #13		
Allowable antenna area in ft <sup>2</sup> *	CSA Class 1 350/450/550 Pa Wind 25mm ice	Round: 50/30/18 Flat: 33/20/12	Round: 114/54/30 Flat: 76/36/20	Round: 136/86/44 Flat: 91/57/29	Round: 238/134/66 Flat: 159/89/44	Round: 296/206/126 Flat: 197/137/84		
	CSA Class 3 350/450/550 Pa Wind 25mm ice	Round: 72/46/30 Flat: 48/31/20	Round: 154/110/58 Flat: 103/73/39	Round: 182/132/92 Flat: 121/88/61	Round: 348/226/142 Flat: 232/151/95	Round: 378/284/216 Flat: 252/189/144		
Shipping Dimensions (L"xW"xH")		2 Bundles: 19"x10"x8" 2 Bundles: 19"x12"x8" 4 Bundles: 19"x15"x8" 1 Crate: 76"x25"x15"	2 Bundles: 19"x10"x8" 2 Bundles: 19"x12"x8" 4 Bundles: 19"x15"x8" 1 Crate: 76"x25"x15"	2 Bundles: 19"x10"x8" 2 Bundles: 19"x12"x8" 4 Bundles: 19"x15"x8" 1 Crate: 76"x25"x15"	2 Bundles: 19"x10"x8" 2 Bundles: 19"x12"x8" 4 Bundles: 19"x15"x8" 1 Crate: 76"x25"x15"	2 Bundles: 19"x10"x8" 2 Bundles: 19"x12"x8" 4 Bundles: 19"x15"x8" 1 Crate: 76"x25"x15"		
Shipping Weight (lbs)		8400	9600	11200	12800			

\*Assumptions: Projected areas (PA) shown are bare; a 1.5 multiplier used for iced area; loads centrally located and balanced at tower top; considers step-pegs, safety cable, and one 1/2" tx line per 10 sq.ft.; "-" indicates tower failure.  
\*Round antennas include omnis, dipoles, dishes with radomes, etc. Antennas where wind hits a round surface. Flat Antennas include flat panels, dishes without radomes and cameras, where wind hits a flat surface.

## Common Accessories

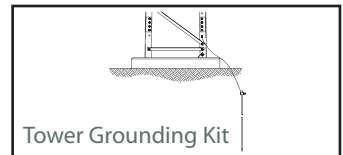
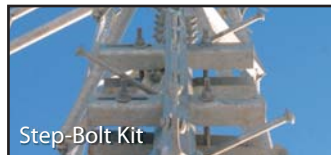
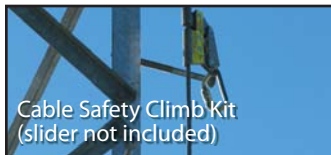

Accessory:	M200	M300	M400	M500	M600		
<b>Cable Safety Climb Kits</b> <i>no slider</i>	4.99.0495.150	4.99.0495.150	4.99.0495.150	4.99.0495.150	4.99.0495.150		
<b>Step-Bolt Kit</b> <i>leg mounted</i>	4.630.S200.146	4.630.S300.146	4.630.S400.146	4.630.S500.146	4.630.S600.146		
<b>Anti-Climb Shield Kits</b>	4.630.0001.213	4.630.0001.213	4.630.0001.213	4.630.0001.213	4.630.0001.213		
<b>Tower Grounding Kit</b> <i>basic, three leg</i>	4.91.0103.003	4.91.0103.003	4.91.0103.003	4.91.0103.003	4.91.0103.003		

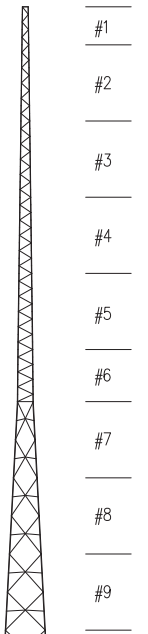
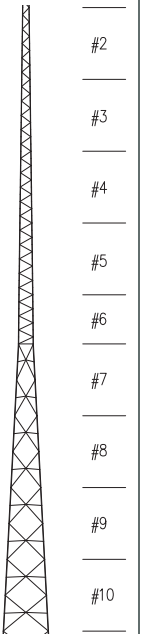
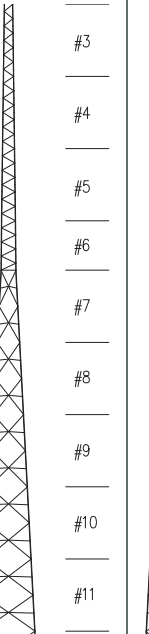
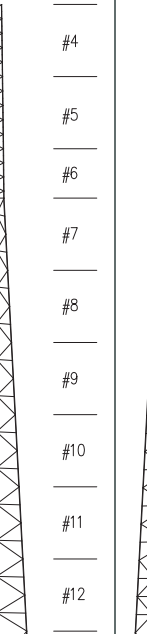
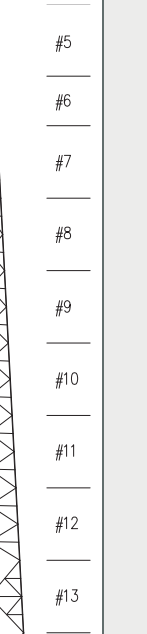
Model Designation:		M110	M210	M310	M410	M510		
Part Number:		5.630.0110.156	5.630.0210.156	5.630.0310.156	5.630.0410.156	5.630.0510.156		
								
Allowable antenna area in ft <sup>2</sup> *	CSA Class 1 350/450/550 Pa Wind 25mm ice	Round: 30/14/4 Flat: 20/9/3	Round: 74/46/14 Flat: 49/31/9	Round: 126/58/30 Flat: 84/39/20	Round: 144/100/46 Flat: 96/57/31	Round: 272/158/86 Flat: 181/105/57		
	CSA Class 3 350/450/550 Pa Wind 25mm ice	Round: 48/30/16 Flat: 32/20/11	Round: 104/70/46 Flat: 69/47/31	Round: 178/120/64 Flat: 119/80/43	Round: 186/140/108 Flat: 124/93/72	Round: 352/258/168 Flat: 235/172/112		
Shipping Dimensions (L"xW"xH")		2 Bundles: 19'x10'x8" 2 Bundles: 19'x12'x8" 4 Bundles: 19'x15'x8" 1 Crate: 76"x25"x15"	2 Bundles: 19'x10'x8" 2 Bundles: 19'x12'x8" 4 Bundles: 19'x15'x8" 1 Crate: 76"x25"x15"	2 Bundles: 19'x10'x8" 2 Bundles: 19'x12'x8" 4 Bundles: 19'x15'x8" 1 Crate: 76"x25"x15"	2 Bundles: 19'x10'x8" 2 Bundles: 19'x12'x8" 4 Bundles: 19'x15'x8" 1 Crate: 76"x25"x15"	2 Bundles: 19'x10'x8" 2 Bundles: 19'x12'x8" 4 Bundles: 19'x15'x8" 1 Crate: 76"x25"x15"		
Shipping Weight (lbs)		8500	9800	11400	13200	15200		

\*Assumptions: Projected areas (PA) shown are bare; a 1.5 multiplier used for iced area; loads centrally located and balanced at tower top; considers step-pegs, safety cable, and one 1/2" tx line per 10 sq.ft.; "-" indicates tower failure.  
\*Round antennas include omnis, dipoles, dishes with radomes, etc. Antennas where wind hits a round surface. Flat Antennas include flat panels, dishes without radomes and cameras, where wind hits a flat surface.



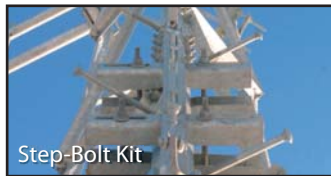
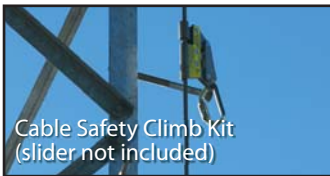

## Common Accessories

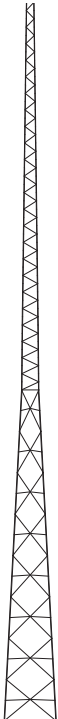
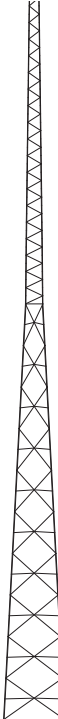

Accessory:	M110	M210	M310	M410	M510		
<b>Cable Safety Climb Kits</b> <i>no slider</i>	4.99.0495.200	4.99.0495.200	4.99.0495.200	4.99.0495.200	4.99.0495.200		
<b>Step-Bolt Kit</b> <i>leg mounted</i>	4.630.S110.156	4.630.S210.156	4.630.S310.156	4.630.S410.156	4.630.S510.156		
<b>Anti-Climb Shield Kits</b>	4.630.0001.213	4.630.0001.213	4.630.0001.213	4.630.0001.213	4.630.0001.213		
<b>Tower Grounding Kit</b> <i>basic, three leg</i>	4.91.0103.003	4.91.0103.003	4.91.0103.003	4.91.0103.003	4.91.0103.003		

# 165' Towers





Model Designation:		M200	M300	M400	M500	M600		
Part Number:		5.630.0219.165	5.630.0319.165	5.630.0419.165	5.630.0519.165	5.630.0619.165		
								
		#2	#3	#4	#5	#6		
		#3	#4	#5	#6	#7		
		#4	#5	#6	#7	#8		
		#5	#6	#7	#8	#9		
		#6	#7	#8	#9	#10		
		#7	#8	#9	#10	#11		
		#8	#9	#10	#11	#12		
		#9	#10	#11	#12	#13		
		#10	#11	#12	#13	#14		
Allowable antenna area in ft <sup>2</sup> *	CSA Class 1 350/450/550 Pa Wind 25mm ice	Round: 46/30/4 Flat: 31/20/3	Round: 108/45/14 Flat: 72/31/9	Round: 132/72/30 Flat: 88/48/20	Round: 224/120/54 Flat: 149/80/36	Round: 288/192/0 Flat: 192/128/0		
	CSA Class 3 350/450/550 Pa Wind 25mm ice	Round: 70/45/30 Flat: 47/31/20	Round: 148/98/48 Flat: 99/55/32	Round: 178/126/78 Flat: 119/84/52	Round: 330/212/128 Flat: 220/141/85	Round: 368/278/202 Flat: 245/185/134		
Shipping Dimensions (L"xW"xH")		2 Bundles: 19x10"x8" 2 Bundles: 19x12"x8" 5 Bundles: 19x15"x8" 1 Crate: 76"x25"x15"	2 Bundles: 19x10"x8" 2 Bundles: 19x12"x8" 5 Bundles: 19x15"x8" 1 Crate: 76"x25"x15"	2 Bundles: 19x10"x8" 2 Bundles: 19x12"x8" 5 Bundles: 19x15"x8" 1 Crate: 76"x25"x15"	2 Bundles: 19x10"x8" 2 Bundles: 19x12"x8" 5 Bundles: 19x15"x8" 1 Crate: 76"x25"x15"	3 Bundles: 19x10"x8" 3 Bundles: 19x12"x8" 6 Bundles: 19x15"x8" 2 Crate: 76"x25"x15"		
Shipping Weight (lbs)		10000	11600	13400	15500	17700		

\*Assumptions: Projected areas (PA) shown are bare; a 1.5 multiplier used for iced area; loads centrally located and balanced at tower top; considers step-pegs, safety cable, and one 1/2" tx line per 10 sq.ft.; "-" indicates tower failure.  
\*Round antennas include omnis, dipoles, dishes with radomes, etc. Antennas where wind hits a round surface. Flat Antennas include flat panels, dishes without radomes and cameras, where wind hits a flat surface.

## Common Accessories

Accessory:	M200	M300	M400	M500	M600		
<b>Cable Safety Climb Kits</b> <i>no slider</i>	4.99.0495.200	4.99.0495.200	4.99.0495.200	4.99.0495.200	4.99.0495.200		
<b>Step-Bolt Kit</b> <i>leg mounted</i>	4.630.S200.165	4.630.S300.165	4.630.S400.165	4.630.S500.165	4.630.S600.165		
<b>Anti-Climb Shield Kits</b>	4.630.0001.213	4.630.0001.213	4.630.0001.213	4.630.0001.213	4.630.0001.213		
<b>Tower Grounding Kit</b> <i>basic, three leg</i>	4.91.0103.003	4.91.0103.003	4.91.0103.003	4.91.0103.003	4.91.0103.003		

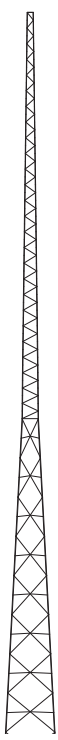
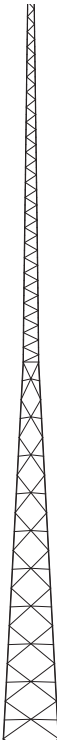
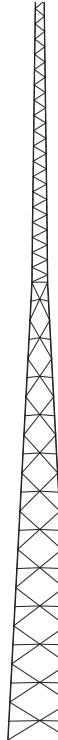

Model Designation:		M110	M210	M310	M410	M510		
Part Number:		5.630.0110.175	5.630.0210.175	5.630.0310.175	5.630.0410.175	5.630.0510.175		
								
		#1 #2 #3 #4 #5 #6 #7 #8 #9 #10	#2 #3 #4 #5 #6 #7 #8 #9 #10 #11	#3 #4 #5 #6 #7 #8 #9 #10 #11 #12	#4 #5 #6 #7 #8 #9 #10 #11 #12 #13	#5 #6 #7 #8 #9 #10 #11 #12 #13 #14		
Allowable antenna area in ft <sup>2</sup> *	CSA Class 1 350/450/550 Pa Wind 25mm ice	Round: 30/14/0 Flat: 20/9/0	Round: 70/30/2 Flat: 47/20/1	Round: 122/52/16 Flat: 81/35/11	Round: 140/88/40 Flat: 93/59/27	Round: 258/146/0 Flat: 172/97/0		
	CSA Class 3 350/450/550 Pa Wind 25mm ice	Round: 46/28/14 Flat: 31/19/9	Round: 100/55/35 Flat: 57/44/24	Round: 172/116/54 Flat: 115/77/36	Round: 182/135/95 Flat: 121/91/64	Round: 344/244/156 Flat: 229/163/104		
Shipping Dimensions (L"xW"xH")		2 Bundles: 19x10"x8" 2 Bundles: 19x12"x8" 5 Bundles: 19x15"x8" 1 Crate: 76"x25"x15"	2 Bundles: 19x10"x8" 2 Bundles: 19x12"x8" 5 Bundles: 19x15"x8" 1 Crate: 76"x25"x15"	2 Bundles: 19x10"x8" 2 Bundles: 19x12"x8" 5 Bundles: 19x15"x8" 1 Crate: 76"x25"x15"	2 Bundles: 19x10"x8" 2 Bundles: 19x12"x8" 5 Bundles: 19x15"x8" 1 Crate: 76"x25"x15"	2 Bundles: 19x10"x8" 2 Bundles: 19x12"x8" 5 Bundles: 19x15"x8" 1 Crate: 76"x25"x15"		
Shipping Weight (lbs)		10500	11700	13600	15900	17800		



\*Assumptions: Projected areas (PA) shown are bare; a 1.5 multiplier used for iced area; loads centrally located and balanced at tower top; considers step-pegs, safety cable, and one 1/2" tx line per 10 sq.ft.; "-" indicates tower failure.  
\*Round antennas include omnis, dipoles, dishes with radomes, etc. Antennas where wind hits a round surface. Flat Antennas include flat panels, dishes without radomes and cameras, where wind hits a flat surface.

## Common Accessories

Accessory:	M110	M210	M310	M410	M510		
<b>Cable Safety Climb Kits</b> <i>no slider</i>	4.99.0495.200	4.99.0495.200	4.99.0495.200	4.99.0495.200	4.99.0495.200		
<b>Step-Bolt Kit</b> <i>leg mounted</i>	4.630.S110.175	4.630.S210.175	4.630.S310.175	4.630.S410.175	4.630.S510.175		
<b>Anti-Climb Shield Kits</b>	4.630.0001.213	4.630.0001.213	4.630.0001.213	4.630.0001.213	4.630.0001.213		
<b>Tower Grounding Kit</b> <i>basic, three leg</i>	4.91.0103.003	4.91.0103.003	4.91.0103.003	4.91.0103.003	4.91.0103.003		

# 184' Towers

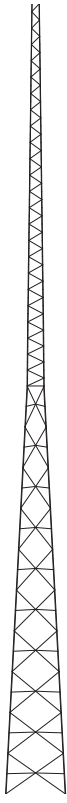
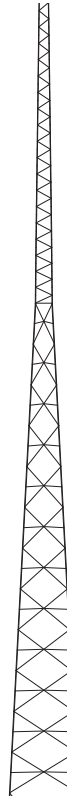



Model Designation:		M200	M300	M400	M500			
Part Number:		5.630.0219.184	5.630.0319.184	5.630.0419.184	5.630.0519.184			
								
		#2	#3	#4	#5			
		#3	#4	#5	#6			
		#4	#5	#6	#7			
		#5	#6	#7	#8			
		#6	#7	#8	#9			
		#7	#8	#9	#10			
		#8	#9	#10	#11			
		#9	#10	#11	#12			
		#10	#11	#12	#13			
		#11	#12	#13	#14			
Allowable antenna area in ft <sup>2</sup> *	CSA Class 1 350/450/550 Pa Wind 25mm ice	Round: 46/22/0 Flat: 31/15/0	Round: 96/40/6 Flat: 54/27/4	Round: 128/60/26 Flat: 85/40/17	Round: 212/110/0 Flat: 141/73/0			
	CSA Class 3 350/450/550 Pa Wind 25mm ice	Round: 56/44/26 Flat: 44/29/17	Round: 144/88/46 Flat: 96/59/31	Round: 172/122/68 Flat: 115/81/45	Round: 318/198/118 Flat: 212/132/79			
Shipping Dimensions (L"xW"xH")		2 Bundles: 19'x10'x8" 2 Bundles: 19'x12'x8" 6 Bundles: 19'x15'x8" 1 Crate: 76'x25'x15"	2 Bundles: 19'x10'x8" 2 Bundles: 19'x12'x8" 6 Bundles: 19'x15'x8" 1 Crate: 76'x25'x15"	2 Bundles: 19'x10'x8" 2 Bundles: 19'x12'x8" 6 Bundles: 19'x15'x8" 1 Crate: 76'x25'x15"	2 Bundles: 19'x10'x8" 2 Bundles: 19'x12'x8" 6 Bundles: 19'x15'x8" 1 Crate: 76'x25'x15"			
Shipping Weight (lbs)		12000	13900	16000	18200			

\*Assumptions: Projected areas (PA) shown are bare; a 1.5 multiplier used for iced area; loads centrally located and balanced at tower top; considers step-pegs, safety cable, and one 1/2" tx line per 10 sq.ft.; "-" indicates tower failure.  
\*Round antennas include omnis, dipoles, dishes with radomes, etc. Antennas where wind hits a round surface. Flat Antennas include flat panels, dishes without radomes and cameras, where wind hits a flat surface.

## Common Accessories

Accessory:	M200	M300	M400	M500			
<b>Cable Safety Climb Kits</b> <i>no slider</i>	4.99.0495.200	4.99.0495.200	4.99.0495.200	4.99.0495.200			
<b>Step-Bolt Kit</b> <i>leg mounted</i>	4.630.5200.184	4.630.5300.184	4.630.5400.184	4.630.5500.184			
<b>Anti-Climb Shield Kits</b>	4.630.0001.213	4.630.0001.213	4.630.0001.213	4.630.0001.213			
<b>Tower Grounding Kit</b> <i>basic, three leg</i>	4.91.0103.003	4.91.0103.003	4.91.0103.003	4.91.0103.003			

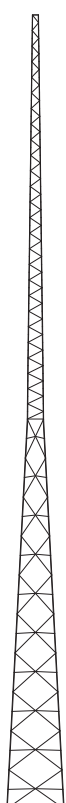
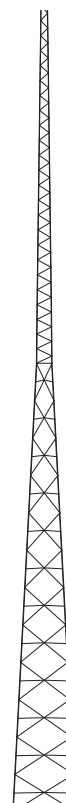
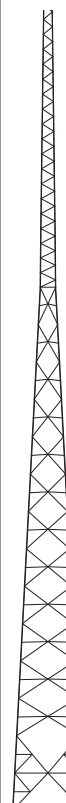

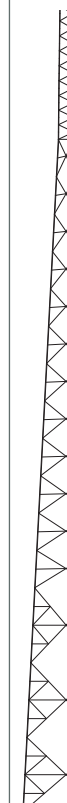
Model Designation:		M110	M210	M310	M410	M510		
Part Number:		5.630.0110.194	5.630.0210.194	5.630.0310.194	5.630.0410.194	5.630.0510.194		
								
		#1 #2 #3 #4 #5 #6 #7 #8 #9 #10 #11	#2 #3 #4 #5 #6 #7 #8 #9 #10 #11 #12	#3 #4 #5 #6 #7 #8 #9 #10 #11 #12 #13	#4 #5 #6 #7 #8 #9 #10 #11 #12 #13 #14	#5 #6 #7 #8 #9 #10 #11 #12 #13 #14 #15		
Allowable antenna area in ft <sup>2</sup> *	CSA Class 1 350/450/550 Pa Wind 25mm ice	Round: 30/14/0 Flat: 20/9/0	Round: 68/30/0 Flat: 45/20/0	Round: 114/46/14 Flat: 76/31/g	Round: 136/78/0 Flat: 91/52/0	Round: 244/136/0 Flat: 163/91/0		
	CSA Class 3 350/450/550 Pa Wind 25mm ice	Round: 46/26/14 Flat: 31/17/9	Round: 98/64/30 Flat: 65/43/20	Round: 166/106/50 Flat: 111/71/33	Round: 176/2/86 Flat: 117/88/57	Round: 336/230/144 Flat: 224/153/96		
Shipping Dimensions (L"xW"xH")		2 Bundles: 19"x10"x8" 2 Bundles: 19"x12"x8" 6 Bundles: 19"x15"x8" 1 Crate: 76"x25"x15"	2 Bundles: 19"x10"x8" 2 Bundles: 19"x12"x8" 6 Bundles: 19"x15"x8" 1 Crate: 76"x25"x15"	2 Bundles: 19"x10"x8" 2 Bundles: 19"x12"x8" 6 Bundles: 19"x15"x8" 1 Crate: 76"x25"x15"	2 Bundles: 19"x10"x8" 2 Bundles: 19"x12"x8" 6 Bundles: 19"x15"x8" 1 Crate: 76"x25"x15"	2 Bundles: 19"x10"x8" 2 Bundles: 19"x12"x8" 6 Bundles: 19"x15"x8" 1 Crate: 76"x25"x15"		
Shipping Weight (lbs)		12200	14000	16250	18500	21200		

\*Assumptions: Projected areas (PA) shown are bare; a 1.5 multiplier used for iced area; loads centrally located and balanced at tower top; considers step-pegs, safety cable, and one 1/2" tx line per 10 sq.ft.; "-" indicates tower failure.  
 \*\*Round antennas include omnis, dipoles, dishes with radomes, etc. Antennas where wind hits a round surface. Flat Antennas include flat panels, dishes without radomes and cameras, where wind hits a flat surface.

## Common Accessories

Accessory:	M110	M210	M310	M410	M510		
<b>Cable Safety Climb Kits</b> <i>no slider</i>	4.99.0495.200	4.99.0495.200	4.99.0495.200	4.99.0495.200	4.99.0495.200		
<b>Step-Bolt Kit</b> <i>leg mounted</i>	4.630.5110.194	4.630.5210.194	4.630.5310.194	4.630.5410.194	4.630.5510.194		
<b>Anti-Climb Shield Kits</b>	4.630.0001.213	4.630.0001.213	4.630.0001.213	4.630.0001.213	4.630.0001.213		
<b>Tower Grounding Kit</b> <i>basic, three leg</i>	4.91.0103.003	4.91.0103.003	4.91.0103.003	4.91.0103.003	4.91.0103.003		



# 203' Towers



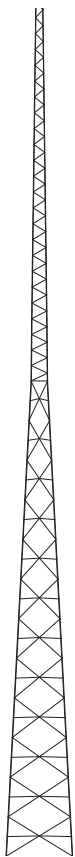
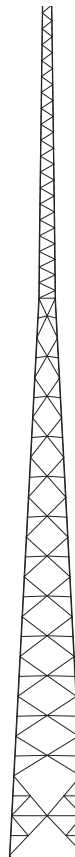
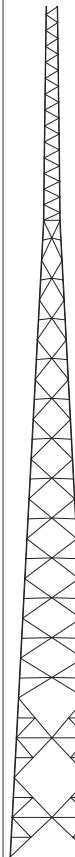
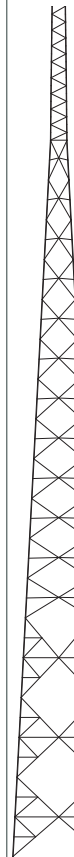



Model Designation:		M200	M300	M400	M500			
Part Number:		5.630.0219.203	5.630.0319.203	5.630.0419.203	5.630.0519.203			
								
		#2	#3	#4	#5			
		#3	#4	#5	#6			
		#4	#5	#6	#7			
		#5	#6	#7	#8			
		#6	#7	#8	#9			
		#7	#8	#9	#10			
		#8	#9	#10	#11			
		#9	#10	#11	#12			
		#10	#11	#12	#13			
		#11	#12	#13	#14			
		#12	#13	#14	#15			
Allowable antenna area in ft <sup>2</sup> *	CSA Class 1 350/450/550 Pa Wind 25mm ice	Round: 44/14/0 Flat: 29/9/0	Round: 88/30/0 Flat: 59/20/0	Round: 124/52/0 Flat: 83/35/0	Round: 200/100/0 Flat: 133/67/0			
	CSA Class 3 350/450/550 Pa Wind 25mm ice	Round: 64/42/18 Flat: 43/28/12	Round: 140/78/36 Flat: 93/52/24	Round: 168/120/58 Flat: 112/80/39	Round: 306/188/108 Flat: 204/125/72			
Shipping Dimensions (L"xW"xH")		9 Bundles: 19'x10"x8" 12 Bundles: 19'x15"x8" 6 Bundle: 19'x18"x8" 6 Crate: 76"x25"x15"	10 Bundles: 19'x10"x8" 13 Bundles: 19'x15"x8" 7 Bundle: 19'x18"x8" 7 Crate: 76"x25"x15"	11 Bundles: 19'x10"x8" 14 Bundles: 19'x15"x8" 8 Bundle: 19'x18"x8" 8 Crate: 76"x25"x15"	12 Bundles: 19'x10"x8" 15 Bundles: 19'x15"x8" 9 Bundle: 19'x18"x8" 9 Crate: 76"x25"x15"			
Shipping Weight (lbs)		14200	16500	18700	21600			

\*Assumptions: Projected areas (PA) shown are bare; a 1.5 multiplier used for iced area; loads centrally located and balanced at tower top; considers step-pegs, safety cable, and one 1/2" tx line per 10 sq.ft.; "-" indicates tower failure.  
\*Round antennas include omnis, dipoles, dishes with radomes, etc. Antennas where wind hits a round surface. Flat Antennas include flat panels, dishes without radomes and cameras, where wind hits a flat surface.

## Common Accessories

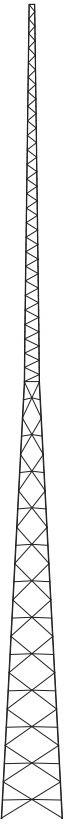
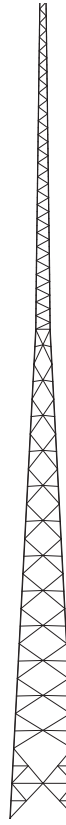
Accessory:	M200	M300	M400	M500			
<b>Cable Safety Climb Kits</b> <i>no slider</i>	4.99.0495.250	4.99.0495.250	4.99.0495.250	4.99.0495.250			
<b>Step-Bolt Kit</b> <i>leg mounted</i>	4.630.S200.203	4.630.S300.203	4.630.S400.203	4.630.S500.203			
<b>Anti-Climb Shield Kits</b>	4.630.0001.213	4.630.0001.213	4.630.0001.213	4.630.0001.213			
<b>Tower Grounding Kit</b> <i>basic, three leg</i>	4.91.0103.003	4.91.0103.003	4.91.0103.003	4.91.0103.003			

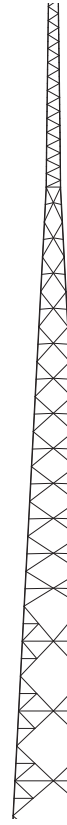

Model Designation:		M110	M210	M310	M410	M510		
Part Number:		5.630.0110.213	5.630.0210.213	5.630.0310.213	5.630.0410.213	5.630.0510.213		
								
		#1 #2 #3 #4 #5 #6 #7 #8 #9 #10 #11 #12	#2 #3 #4 #5 #6 #7 #8 #9 #10 #11 #12 #13	#3 #4 #5 #6 #7 #8 #9 #10 #11 #12 #13 #14	#4 #5 #6 #7 #8 #9 #10 #11 #12 #13 #14 #15	#5 #6 #7 #8 #9 #10 #11 #12 #13 #14 #15 #16		
Allowable antenna area in ft <sup>2</sup> *	CSA Class 1 350/450/550 Pa Wind 25mm ice	Round: 28/8/0 Flat: 19/5/0	Round: 64/22/0 Flat: 43/15/0	Round: 106/42/0 Flat: 71/B/0	Round: 134/70/0 Flat: 89/47/0	Round: 234/46/0 Flat: 156/31/0		
	CSA Class 3 350/450/550 Pa Wind 25mm ice	Round: 44/26/12 Flat: 29/17/8	Round: 94/56/28 Flat: 63/37/19	Round: 162/98/46 Flat: 108/65/31	Round: 174/130/78 Flat: 116/87/52	Round: 330/220/52 Flat: 220/147/35		
Shipping Dimensions (L"xW"xH")		4 Bundles: 19x10"x8" 7 Bundles: 19x15"x8" 1 Bundle: 19x18"x8" 1 Crate: 76"x25"x15"	5 Bundles: 19x10"x8" 8 Bundles: 19x15"x8" 2 Bundle: 19x18"x8" 2 Crate: 76"x25"x15"	6 Bundles: 19x10"x8" 9 Bundles: 19x15"x8" 3 Bundle: 19x18"x8" 3 Crate: 76"x25"x15"	7 Bundles: 19x10"x8" 10 Bundles: 19x15"x8" 4 Bundle: 19x18"x8" 4 Crate: 76"x25"x15"	8 Bundles: 19x10"x8" 11 Bundles: 19x15"x8" 5 Bundle: 19x18"x8" 5 Crate: 76"x25"x15"		
Shipping Weight (lbs)		14600	16900	19200	22100	25000		

\*Assumptions: Projected areas (PA) shown are bare; a 1.5 multiplier used for iced area; loads centrally located and balanced at tower top; considers step-pegs, safety cable, and one 1/2" tx line per 10 sq.ft.; "-" indicates tower failure.  
 \*\*Round antennas include omnis, dipoles, dishes with radomes, etc. Antennas where wind hits a round surface. Flat Antennas include flat panels, dishes without radomes and cameras, where wind hits a flat surface.

## Common Accessories

Accessory:	M110	M210	M310	M410	M510		
<b>Cable Safety Climb Kits</b> <i>no slider</i>	4.99.0495.250	4.99.0495.250	4.99.0495.250	4.99.0495.250	4.99.0495.250		
<b>Step-Bolt Kit</b> <i>leg mounted</i>	4.630.5110.213	4.630.5210.213	4.630.5310.213	4.630.5410.213	4.630.5510.213		
<b>Anti-Climb Shield Kits</b>	4.630.0001.213	4.630.0001.213	4.630.0001.213	4.630.0001.213	4.630.0001.213		
<b>Tower Grounding Kit</b> <i>basic, three leg</i>	4.91.0103.003	4.91.0103.003	4.91.0103.003	4.91.0103.003	4.91.0103.003		

# 222' Towers

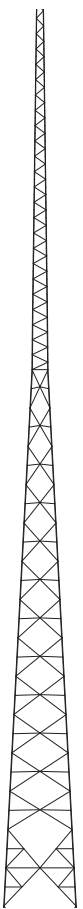
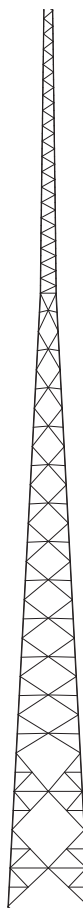
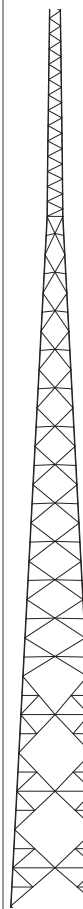
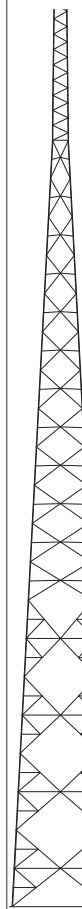

Model Designation:		M200	M300	M400	M500			
Part Number:		5.630.0219.222	5.630.0319.222	5.630.0419.222	5.630.0519.222			
								
		#2	#3	#4	#5			
		#3	#4	#5	#6			
		#4	#5	#6	#7			
		#5	#6	#7	#8			
		#6	#7	#8	#9			
		#7	#8	#9	#10			
		#8	#9	#10	#11			
		#9	#10	#11	#12			
		#10	#11	#12	#13			
		#11	#12	#13	#14			
		#12	#13	#14	#15			
		#13	#14	#15	#16			
Allowable antenna area in ft <sup>2</sup> *	CSA Class 1 350/450/550 Pa Wind 25mm ice	Round: 44/14/0 Flat: 29/9/0	Round: 80/30/0 Flat: 53/20/0	Round: 122/50/0 Flat: 81/33/0	Round: 190/46/0 Flat: 127/31/0			
	CSA Class 3 350/450/550 Pa Wind 25mm ice	Round: 62/40/14 Flat: 41/27/9	Round: 138/72/30 Flat: 92/48/20	Round: 164/116/52 Flat: 109/77/35	Round: 296/178/52 Flat: 197/119/35			
Shipping Dimensions (L"xW"xH")		8 Bundles: 19x10"x8" 12 Bundles: 19x15"x8" 5 Bundle: 19x18"x8" 5 Crate: 76"x25"x15"	9 Bundles: 19x10"x8" 13 Bundles: 19x15"x8" 6 Bundle: 19x18"x8" 6 Crate: 76"x25"x15"	10 Bundles: 19x10"x8" 14 Bundles: 19x15"x8" 7 Bundle: 19x18"x8" 7 Crate: 76"x25"x15"	11 Bundles: 19x10"x8" 15 Bundles: 19x15"x8" 8 Bundle: 19x18"x8" 8 Crate: 76"x25"x15"			
Shipping Weight (lbs)		17000	19400	22400	25400			

\*Assumptions: Projected areas (PA) shown are bare; a 1.5 multiplier used for iced area; loads centrally located and balanced at tower top; considers step-pegs, safety cable, and one 1/2" tx line per 10 sq.ft.; "-" indicates tower failure.  
\*Round antennas include omnis, dipoles, dishes with radomes, etc. Antennas where wind hits a round surface. Flat Antennas include flat panels, dishes without radomes and cameras, where wind hits a flat surface.

## Common Accessories

Accessory:	M200	M300	M400	M500			
<b>Cable Safety Climb Kits</b> <i>no slider</i>	4.99.0495.250	4.99.0495.250	4.99.0495.250	4.99.0495.250			
<b>Step-Bolt Kit</b> <i>leg mounted</i>	4.630.S200.222	4.630.S300.222	4.630.S400.222	4.630.S500.222			
<b>Anti-Climb Shield Kits</b>	4.630.0001.213	4.630.0001.213	4.630.0001.213	4.630.0001.213			

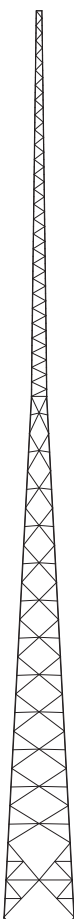
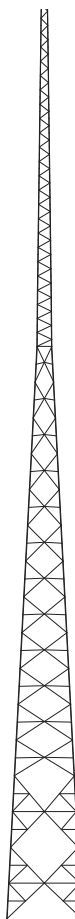
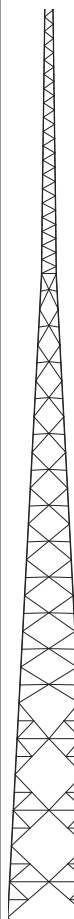
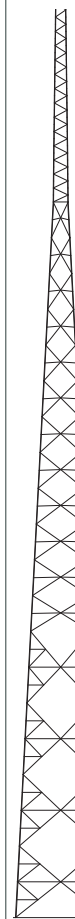

Model Designation:		M110	M210	M310	M410			
Part Number:		5.630.0110.232	5.630.0210.232	5.630.0310.232	5.630.0410.232			
								
		#1 #2 #3 #4 #5 #6 #7 #8 #9 #10 #11 #12 #13	#2 #3 #4 #5 #6 #7 #8 #9 #10 #11 #12 #13 #14	#3 #4 #5 #6 #7 #8 #9 #10 #11 #12 #13 #14 #15	#4 #5 #6 #7 #8 #9 #10 #11 #12 #13 #14 #15 #16			
Allowable antenna area in ft <sup>2</sup> *	CSA Class 1 350/450/550 Pa Wind 25mm ice	Round: 26/2/0 Flat: 17/1/0	Round: 56/14/0 Flat: 37/9/0	Round: 100/36/0 Flat: 67/24/0	Round: 130/46/0 Flat: 87/31/0			
	CSA Class 3 350/450/550 Pa Wind 25mm ice	Round: 42/24/6 Flat: 28/16/4	Round: 92/52/20 Flat: 51/35/13	Round: 158/90/42 Flat: 105/60/28	Round: 170/126/70 Flat: 3/84/47			
Shipping Dimensions (L"xW"xH")		4 Bundles: 19x10"x8" 8 Bundles: 19x15"x8" 1 Bundle: 19x18"x8" 1 Crate: 76"x25"x15"	5 Bundles: 19x10"x8" 9 Bundles: 19x15"x8" 2 Bundle: 19x18"x8" 2 Crate: 76"x25"x15"	6 Bundles: 19x10"x8" 10 Bundles: 19x15"x8" 3 Bundle: 19x18"x8" 3 Crate: 76"x25"x15"	7 Bundles: 19x10"x8" 11 Bundles: 19x15"x8" 4 Bundle: 19x18"x8" 4 Crate: 76"x25"x15"			
Shipping Weight (lbs)		17200	19600	22550	25700			

\*Assumptions: Projected areas (PA) shown are bare; a 1.5 multiplier used for iced area; loads centrally located and balanced at tower top; considers step-pegs, safety cable, and one 1/2" tx line per 10 sq.ft.; "-" indicates tower failure.  
\*Round antennas include omnis, dipoles, dishes with radomes, etc. Antennas where wind hits a round surface. Flat Antennas include flat panels, dishes without radomes and cameras, where wind hits a flat surface.

## Common Accessories

Accessory:	M110	M210	M310	M410			
<b>Cable Safety Climb Kits</b> <i>no slider</i>	4.99.0495.250	4.99.0495.250	4.99.0495.250	4.99.0495.250			
<b>Step-Bolt Kit</b> <i>leg mounted</i>	4.630.S110.232	4.630.S210.232	4.630.S310.232	4.630.S410.232			
<b>Anti-Climb Shield Kits</b>	4.630.0001.213	4.630.0001.213	4.630.0001.213	4.630.0001.213			

# 241' Towers

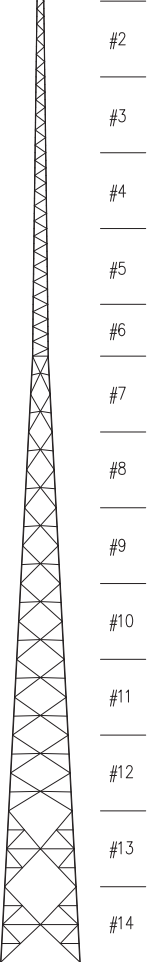
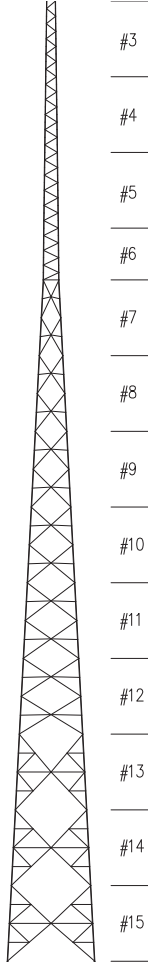
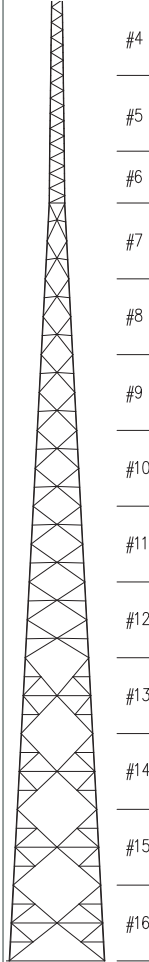

Model Designation:		M200	M300	M400				
Part Number:		5.630.0219.241	5.630.0319.241	5.630.0419.241				
								
		#2	#3	#4				
		#3	#4	#5				
		#4	#5	#6				
		#5	#6	#7				
		#6	#7	#8				
		#7	#8	#9				
		#8	#9	#10				
		#9	#10	#11				
		#10	#11	#12				
		#11	#12	#13				
		#12	#13	#14				
		#13	#14	#15				
		#14	#15	#16				
Allowable antenna area in ft <sup>2</sup> *	CSA Class 1 350/450/550 Pa Wind 25mm ice	Round: 42/8/0 Flat: 28/5/0	Round: 72/24/0 Flat: 48/16/0	Round: 118/46/0 Flat: 79/31/0				
	CSA Class 3 350/450/550 Pa Wind 25mm ice	Round: 60/38/14 Flat: 40/25/9	Round: 134/64/30 Flat: 89/43/20	Round: 160/110/50 Flat: 107/73/33				
Shipping Dimensions (L"xW"xH")		4 Bundles: 19x10"x8" 9 Bundles: 19x15"x8" 1 Bundle: 19x18"x8" 1 Crate: 76"x25"x15"	4 Bundles: 19x10"x8" 9 Bundles: 19x15"x8" 1 Bundle: 19x18"x8" 1 Crate: 76"x25"x15"	4 Bundles: 19x10"x8" 9 Bundles: 19x15"x8" 1 Bundle: 19x18"x8" 1 Crate: 76"x25"x15"				
Shipping Weight (lbs)		19700	22800	25900				

\*Assumptions: Projected areas (PA) shown are bare; a 1.5 multiplier used for iced area; loads centrally located and balanced at tower top; considers step-pegs, safety cable, and one 1/2" tx line per 10 sq.ft.; "-" indicates tower failure.  
\*Round antennas include omnis, dipoles, dishes with radomes, etc. Antennas where wind hits a round surface. Flat Antennas include flat panels, dishes without radomes and cameras, where wind hits a flat surface.

## Common Accessories

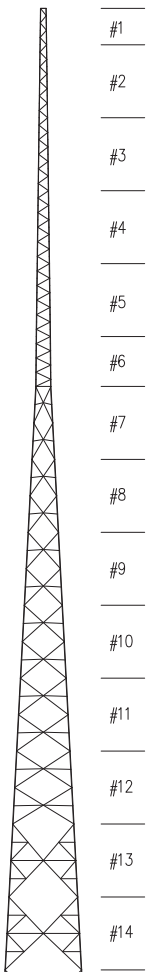
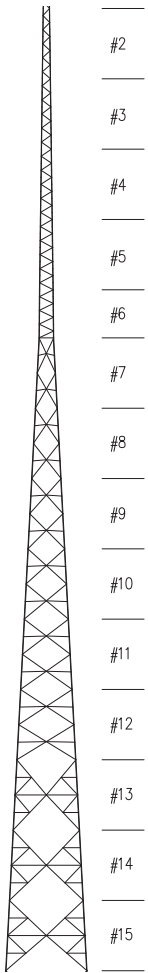
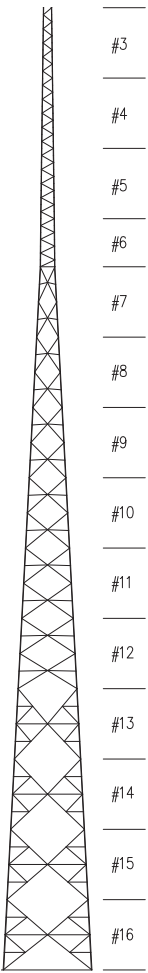

Accessory	M100	M200	M300				
<b>Cable Safety Climb Kits</b> <i>no slider</i>	4.99.0495.250	4.99.0495.250	4.99.0495.250				
<b>Step-Bolt Kit</b> <i>leg mounted</i>	4.630.S200.241	4.630.S300.241	4.630.S400.241				



Model Designation:		M110	M210	M310				
Part Number		5.630.0110.251	5.630.0210.251	5.630.0310.251				
								
		#1 #2 #3 #4 #5 #6 #7 #8 #9 #10 #11 #12 #13 #14	#2 #3 #4 #5 #6 #7 #8 #9 #10 #11 #12 #13 #14 #15	#3 #4 #5 #6 #7 #8 #9 #10 #11 #12 #13 #14 #15 #16				
Allowable antenna area in ft <sup>2</sup> *	CSA Class 1 350/450/550 Pa Wind 25mm ice	Round: 24/0/0 Flat: 16/0/0	Round: 52/14/0 Flat: 35/9/0	Round: 92/30/0 Flat: 61/20/0				
	CSA Class 3 350/450/550 Pa Wind 25mm ice	Round: 42/22/0 Flat: 28/15/0	Round: 90/50/14 Flat: 60/33/9	Round: 154/82/36 Flat: 103/55/24				
Shipping Dimensions (L"xW"xH")		4 Bundles: 19'x10'x8" 9 Bundles: 19'x15'x8" 1 Bundle: 19'x18'x8" 1 Crate: 76'x25'x15"	4 Bundles: 19'x10'x8" 9 Bundles: 19'x15'x8" 1 Bundle: 19'x18'x8" 1 Crate: 76'x25'x15"	4 Bundles: 19'x10'x8" 9 Bundles: 19'x15'x8" 1 Bundle: 19'x18'x8" 1 Crate: 76'x25'x15"				
Shipping Weight (lbs)		19900	23000	26100				

\*Assumptions: Projected areas (PA) shown are bare; a 1.5 multiplier used for iced area; loads centrally located and balanced at tower top; considers step-pegs, safety cable, and one 1/2" tx line per 10 sq.ft.; "-" indicates tower failure.  
 \*Round antennas include omnis, dipoles, dishes with radomes, etc. Antennas where wind hits a round surface. Flat Antennas include flat panels, dishes without radomes and cameras, where wind hits a flat surface.

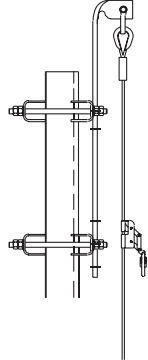
## Common Accessories

Accessory	M110	M210	M310				
<b>Cable Safety Climb Kits</b> <i>no slider</i>	4.99.0495.250	4.99.0495.250	4.99.0495.250				
<b>Step-Bolt Kit</b> <i>leg mounted</i>	4.630.S110.251	4.630.S210.251	4.630.S310.251				

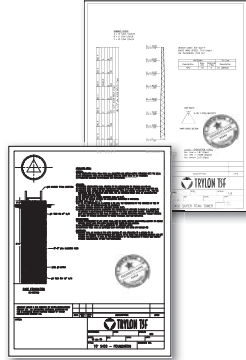
Description:	Beacon Light Kit/Strobe Kit	Cable Safety Climb Kits	Cluster Antenna Mounts
Part Number	Varies	Varies	Varies
	 <p>Beacon Light Kit Strobe Kit</p>		 <p>6-cluster Antenna Mount</p>

Description:	Step-Bolt Climbing Kits	P.E. Stamped Drawings	Factory Painted Towers - Orange & White, Water-Based
Part Number	Varies	Varies	Varies
			

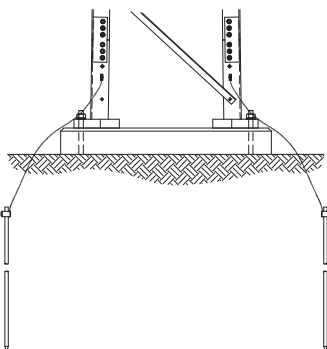
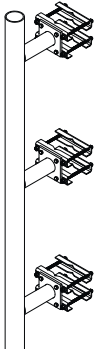
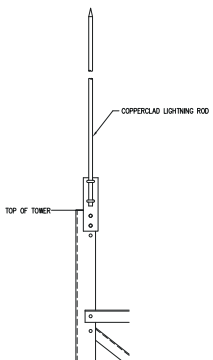
Description:	Tower Grounding Kit	Heavy Stand-Off Mounts	Lightning Rod
Part Number	4.91.0103.003	Varies	4.90.0200.C05
			 <p>COPPERLOAD LIGHTNING ROD TOP OF TOWER</p>





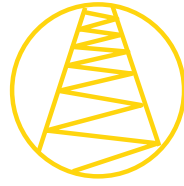
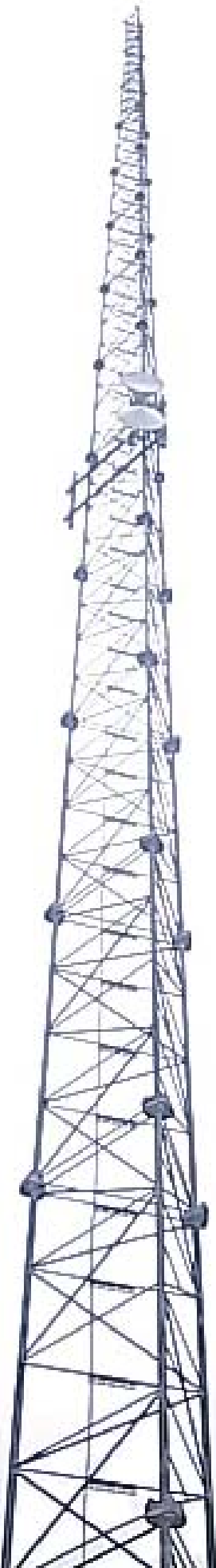

# SUPER TITAN™ WELD

- .. CSA compliant
- .. Up to 150' Self-Support Tower
- .. Standard 10' sections
- .. Flat flanges provides an easy connection between sections (3 bolts per leg)
- .. All-Weld sections minimize assembly and installation time
- .. Applications:
  - ... 2-way applications
  - ... Wireless broadband
  - ... SCADA

The SuperTitan Weld is designed to meet market loading requirements and conforms to ANSI-TIA 222-G Standard. Tylon understands the importance of minimizing freight costs and as a result the tower is designed to ship nested.

The all-weld design uses flat pads allows for easy connections, which further minimizes assembly and installation time. The tower ships with integral climbing face and transmission line supports which offer additional value and eliminate the need to purchase separately. P.E. stamped drawings are available.

### SUPERTITAN WELD SPECIFICATIONS

- All-Weld sections minimize assembly and installation time
- Flat flanges provides an easy connection between sections (3 bolts per leg)
- Designed to conform with ANSI-TIA-222 F&G Standard
- Climbing horizontals on one face (7/8" or 3/4")
- Every 5th section nests for reduced freight costs
- Maximum height: 150ft
- Section height: 10ft

### SUPERTITAN WELD APPLICATIONS

- Oil and gas sites
- Railways: minimizes access time required
- Tower Contractors: minimizes assembly
- Ideal loading capacity for SCADA, WISP, Broadband and 2-Way applications

### THE SUPERTITAN WELD DIFFERENCE

- Only All-Weld Self-Support available through distribution
- 3 hole bolts pattern and flat flanges
- Towers ship nested to minimizes freight costs



**The flat pads make installation easy**



**Tower ships nested to minimize freight**



**Integral transmission line supports**

# 20' Towers



Model Designation:		W080	W100	W200	W300	W400	W500	W600
Part Number:		5.640.0080.020	5.640.0100.020	5.640.0200.020	5.640.0300.020	5.640.0400.020	5.640.0500.020	5.640.0600.020
		Sec #1 Sec #1	Sec #1 Sec #2	Sec #2 Sec #3	Sec #3 Sec #4	Sec #4 Sec #5	Sec #5 Sec #6	Sec #6 Sec #7
Allowable antenna area in ft <sup>2</sup> at:*	CSA-S37-01 350/450/550 Pa Wind 25mm ice	--/--	90/68/54	194/148/120	220/168/136	228/176/144	224/172/136	216/166/132
Shipping Weight (lbs)		550	880	1071	1244	1388	1579	1631





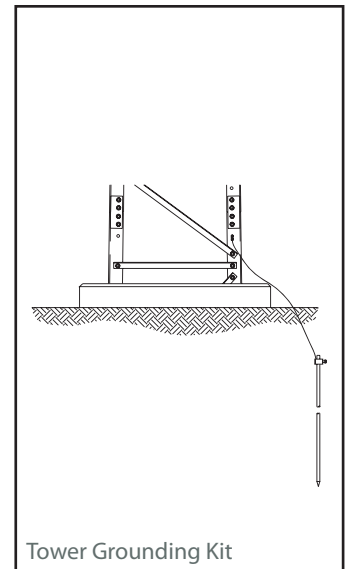

\*Assumptions: Projected areas (PA) shown are bare; a 1.5 multiplier used for iced area; loads centrally located and balanced at tower top; considers step-pegs, safety cable, and one 1/2" tx line per 10 sq.ft.; "--" indicates tower failure.  
\*Round antennas include omnis, dipoles, dishes with radomes, etc. Antennas where wind hits a round surface. Flat Antennas include flat panels, dishes without radomes and cameras, where wind hits a flat surface.

## Common Accessories



Accessory:	W080	W100	W200	W300	W400	W500	W600
<b>Cable Safety Climb Kits</b> <i>no slider</i>	4.99.0220.000	4.99.0220.000	4.99.0220.000	4.99.0220.000	4.99.0220.000	4.99.0220.000	4.99.0220.000
<b>Lighting Kit</b>	4.942.1024.150	4.942.1024.150	4.942.1024.150	4.942.1024.150	4.942.1024.150	4.942.1024.150	4.942.1024.150
<b>Anti-Climb Shield Kits</b>	4.936.0026.001	4.936.0026.002	4.936.0026.003	4.936.0026.004	4.936.0026.005	4.936.0026.006	4.936.0026.007
<b>Tower Grounding Kit</b> <i>basic, single leg</i>	4.912.1177.100	4.912.1177.100	4.912.1177.125	4.912.1177.150	4.912.1177.175	4.912.1177.175	4.912.1177.175



Model Designation:		W060	W080	W100	W200	W300	W400	W500
Part Number:		5.640.0060.030	5.640.0080.030	5.640.0100.030	5.640.0200.030	5.640.0300.030	5.640.0400.030	5.640.0500.030
		 Sec #1  Sec #1  Sec #1	 Sec #1  Sec #1  Sec #2	 Sec #1  Sec #2  Sec #3	 Sec #2  Sec #3  Sec #4	 Sec #3  Sec #4  Sec #5	 Sec #4  Sec #5  Sec #6	 Sec #5  Sec #6  Sec #7
Allowable antenna area in ft <sup>2</sup> at:*	CSA-S37-01 350/450/550 Pa Wind 25mm ice	-/-/-	-/-/-	82/62/50	124/92/74	202/154/124	210/162/130	206/158/124
Shipping Weight (lbs)		700	1,093	1,291	1,455	1,704	1,961	2,089

\*Assumptions: Projected areas (PA) shown are bare; a 1.5 multiplier used for iced area; loads centrally located and balanced at tower top; considers step-pegs, safety cable, and one 1/2" tx line per 10 sq.ft.; "-" indicates tower failure.  
 \*Round antennas include omnis, dipoles, dishes with radomes, etc. Antennas where wind hits a round surface. Flat Antennas include flat panels, dishes without radomes and cameras, where wind hits a flat surface.

## Common Accessories

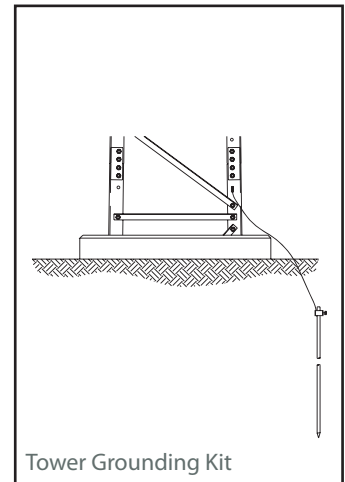

Accessory:	W060	W080	W100	W200	W300	W400	W500
<b>Cable Safety Climb Kits</b> <i>no slider</i>	4.99.0250.000	4.99.0250.000	4.99.0250.000	4.99.0250.000	4.99.0250.000	4.99.0250.000	4.99.0250.000
<b>Lighting Kit</b>	4.942.1024.150	4.942.1024.150	4.942.1024.150	4.942.1024.150	4.942.1024.150	4.942.1024.150	4.942.1024.150
<b>Anti-Climb Shield Kits</b>	4.936.0026.001	4.936.0026.002	4.936.0026.003	4.936.0026.004	4.936.0026.005	4.936.0026.006	4.936.0026.007
<b>Tower Grounding Kit</b> <i>basic, single leg</i>	4.912.1177.100	4.912.1177.100	4.912.1177.125	4.912.1177.150	4.912.1177.175	4.912.1177.175	4.912.1177.175

# 40' Towers



Model Designation:		W040	W060	W080	W100	W200	W300	W400
Part Number:		5.640.0040.040	5.640.0060.040	5.640.0080.040	5.640.0100.040	5.640.0200.040	5.640.0300.040	5.640.0400.040
Allowable antenna area in ft <sup>2</sup> at:*	CSA-S37-01 350/450/550 Pa Wind 25mm ice	-/-/-	-/-/-	-/-/-	76/56/46	116/86/68	168/126/98	184/138/110
Shipping Weight (lbs)		1,020	1,245	1,510	1,675	1,915	2,278	2,471

\*Assumptions: Projected areas (PA) shown are bare; a 1.5 multiplier used for iced area; loads centrally located and balanced at tower top; considers step-pegs, safety cable, and one 1/2" tx line per 10 sq.ft.; "-" indicates tower failure.  
\*Round antennas include omnis, dipoles, dishes with radomes, etc. Antennas where wind hits a round surface. Flat Antennas include flat panels, dishes without radomes and cameras, where wind hits a flat surface.

## Common Accessories

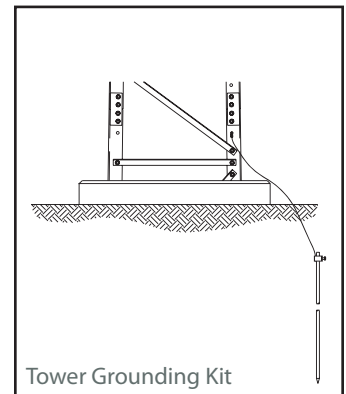

Accessory:	W040	W060	W080	W100	W200	W300	W400
<b>Cable Safety Climb Kits</b> <i>no slider</i>	4.99.0250.000	4.99.0250.000	4.99.0250.000	4.99.0250.000	4.99.0250.000	4.99.0250.000	4.99.0250.000
<b>Lighting Kit</b>	4.942.1024.150	4.942.1024.150	4.942.1024.150	4.942.1024.150	4.942.1024.150	4.942.1024.150	4.942.1024.150
<b>Anti-Climb Shield Kits</b>	4.936.0026.001	4.936.0026.002	4.936.0026.003	4.936.0026.004	4.936.0026.005	4.936.0026.006	4.936.0026.007
<b>Tower Grounding Kit</b> <i>basic, single leg</i>	4.912.1177.100	4.912.1177.100	4.912.1177.125	4.912.1177.150	4.912.1177.175	4.912.1177.175	4.912.1177.175



Model Designation:		W020	W040	W060	W080	W100	W200	W300
Part Number:		5.640.0020.050	5.640.0040.050	5.640.0060.050	5.640.0080.050	5.640.0100.050	5.640.0200.050	5.640.0300.050
Allowable antenna area in ft <sup>2</sup> at:	CSA-S37-01 350/450/550 Pa Wind 25mm ice	--/--	--/--	--/--	--/--	74/52/44	110/82/64	130/94/72
Shipping Weight (lbs)		1,215	1,385	1,620	1,894	2,135	2,489	2,788

\*Assumptions: Projected areas (PA) shown are bare; a 1.5 multiplier used for iced area; loads centrally located and balanced at tower top; considers step-pegs, safety cable, and one 1/2" tx line per 10 sq.ft.; "--" indicates tower failure.  
\*Round antennas include omnis, dipoles, dishes with radomes, etc. Antennas where wind hits a round surface. Flat Antennas include flat panels, dishes without radomes and cameras, where wind hits a flat surface.

## Common Accessories

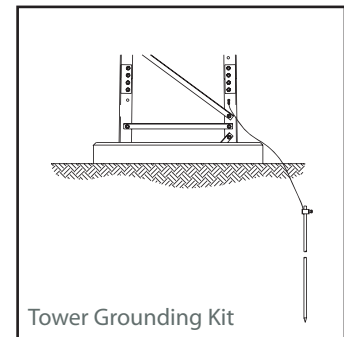
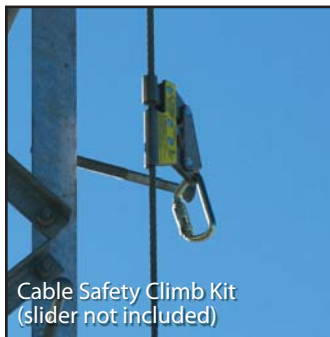

Accessory:	W020	W040	W060	W080	W100	W200	W300
<b>Cable Safety Climb Kits</b> <i>no slider</i>	4.99.0250.000	4.99.0250.000	4.99.0250.000	4.99.0250.000	4.99.0250.000	4.99.0250.000	4.99.0250.000
<b>Lighting Kit</b>	4.942.1024.150	4.942.1024.150	4.942.1024.150	4.942.1024.150	4.942.1024.150	4.942.1024.150	4.942.1024.150
<b>Anti-Climb Shield Kits</b>	4.936.0026.001	4.936.0026.002	4.936.0026.003	4.936.0026.004	4.936.0026.005	4.936.0026.006	4.936.0026.007
<b>Tower Grounding Kit</b> <i>basic, single leg</i>	4.912.1177.100	4.912.1177.100	4.912.1177.125	4.912.1177.150	4.912.1177.175	4.912.1177.175	4.912.1177.175

Model Designation:		W400	W500	W600	W700	W800	W900	W1000
Part Number:		5.640.0400.050	5.640.0500.050	5.640.0600.050	5.640.0700.050	5.640.0800.050	5.640.0900.050	5.640.1000.050
Allowable antenna area in ft <sup>2</sup> at:*	CSA-S37-01 350/450/550 Pa Wind 25mm ice	174/132/104	186/140/110	178/136/108	266/190/142	252/184/140	244/180/140	238/178/140
Shipping Weight (lbs)		3,069	3,345	3,602	3,944	4,303	4,689	5,083

\*Assumptions: Projected areas (PA) shown are bare; a 1.5 multiplier used for iced area; loads centrally located and balanced at tower top; considers step-pegs, safety cable, and one 1/2" tx line per 10 sq.ft.; "-" indicates tower failure.  
\*Round antennas include omnis, dipoles, dishes with radomes, etc. Antennas where wind hits a round surface. Flat Antennas include flat panels, dishes without radomes and cameras, where wind hits a flat surface.

## Common Accessories

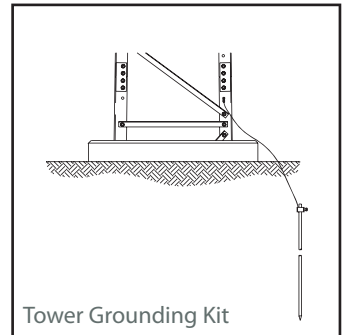
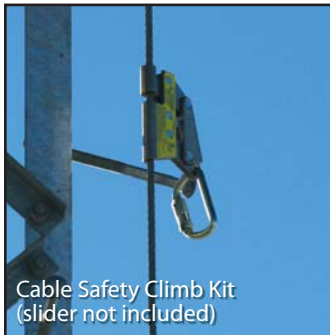

Accessory:	W400	W500	W600	W700	W800	W900	W1000
<b>Cable Safety Climb Kits</b> <i>no slider</i>	4.99.0250.000	4.99.0250.000	4.99.0250.000	4.99.0250.000	4.99.0250.000	4.99.0250.000	4.99.0250.000
<b>Lighting Kit</b>	4.942.1024.150	4.942.1024.150	4.942.1024.150	4.942.1024.150	4.942.1024.150	4.942.1024.150	4.942.1024.150
<b>Anti-Climb Shield Kits</b>	4.936.0026.008	4.936.0026.009	4.936.0026.010	4.936.0026.011	4.936.0026.012	4.936.0026.013	4.936.0026.014
<b>Tower Grounding Kit</b> <i>basic, single leg</i>	4.912.1177.225	4.912.1177.225	4.912.1177.225	4.912.1177.250	4.912.1177.250	4.912.1177.250	4.912.1177.250

Model Designation:	W020	W040	W060	W080	W100	W200	W300
Part Number:	5.640.0020.060	5.640.0040.060	5.640.0060.060	5.640.0080.060	5.640.0100.060	5.640.0200.060	5.640.0300.060
Allowable antenna area in ft <sup>2</sup> at: CSA-S37-01 350/450/550 Pa Wind 25mm ice	--/--	--/--	--/--	--/--	70/52/40	94/66/52	124/90/68
Shipping Weight (lbs)	1,600	1,785	2,025	2,354	2,708	2,999	3,386

\*Assumptions: Projected areas (PA) shown are bare; a 1.5 multiplier used for iced area; loads centrally located and balanced at tower top; considers step-pegs, safety cable, and one 1/2" tx line per 10 sq.ft.; "--" indicates tower failure.  
\*Round antennas include omnis, dipoles, dishes with radomes, etc. Antennas where wind hits a round surface. Flat Antennas include flat panels, dishes without radomes and cameras, where wind hits a flat surface.

## Common Accessories

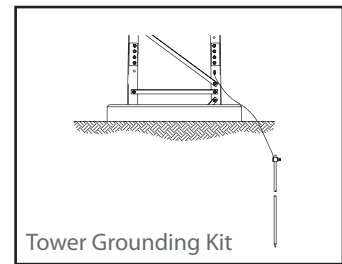

Accessory:	W020	W040	W060	W080	W100	W200	W300
<b>Cable Safety Climb Kits</b> <i>no slider</i>	4.99.0300.000	4.99.0300.000	4.99.0300.000	4.99.0300.000	4.99.0300.000	4.99.0300.000	4.99.0300.000
<b>Lighting Kit</b>	4.942.1024.150	4.942.1024.150	4.942.1024.150	4.942.1024.150	4.942.1024.150	4.942.1024.150	4.942.1024.150
<b>Anti-Climb Shield Kits</b>	4.936.0026.002	4.936.0026.003	4.936.0026.004	4.936.0026.005	4.936.0026.006	4.936.0026.007	4.936.0026.008
<b>Tower Grounding Kit</b> <i>basic, single leg</i>	4.912.1177.100	4.912.1177.125	4.912.1177.150	4.912.1177.175	4.912.1177.175	4.912.1177.175	4.912.1177.225



Model Designation:		W400	W500	W600	W700	W800	W900	W1000
Part Number:		5.640.0400.060	5.640.0500.060	5.640.0600.060	5.640.0700.060	5.640.0800.060	5.640.0900.060	5.640.1000.060
Allowable antenna area in ft <sup>2</sup> at:	CSA-S37-01 350/450/550 Pa Wind 25mm ice	168/126/98	178/134/104	170/130/104	252/180/134	240/174/132	232/172/132	228/170/134
Shipping Weight (lbs)		3,727	4,061	4,416	4,812	5,285	5,723	6,100

\*Assumptions: Projected areas (PA) shown are bare; a 1.5 multiplier used for iced area; loads centrally located and balanced at tower top; considers step-pegs, safety cable, and one 1/2" tx line per 10 sq.ft.; "-" indicates tower failure.  
 \*Round antennas include omnis, dipoles, dishes with radomes, etc. Antennas where wind hits a round surface. Flat Antennas include flat panels, dishes without radomes and cameras, where wind hits a flat surface.

## Common Accessories

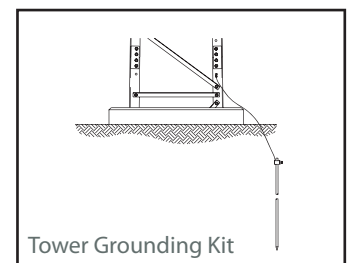
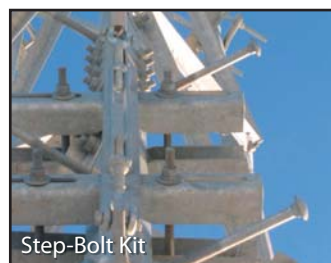
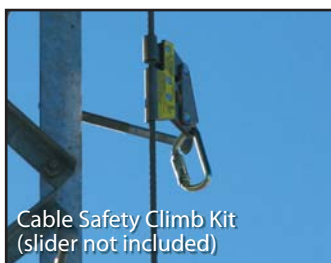

Accessory:	W400	W500	W600	W700	W800	W900	W1000
<b>Cable Safety Climb Kits</b> <i>no slider</i>	4.99.0300.000	4.99.0300.000	4.99.0300.000	4.99.0300.000	4.99.0300.000	4.99.0300.000	4.99.0300.000
<b>Lighting Kit</b>	4.942.1024.150	4.942.1024.150	4.942.1024.150	4.942.1024.150	4.942.1024.150	4.942.1024.150	4.942.1024.150
<b>Anti-Climb Shield Kits</b>	4.936.0026.009	4.936.0026.010	4.936.0026.011	4.936.0026.012	4.936.0026.013	4.936.0026.014	4.936.0026.015
<b>Tower Grounding Kit</b> <i>basic, single leg</i>	4.912.1177.225	4.912.1177.225	4.912.1177.250	4.912.1177.250	4.912.1177.250	4.912.1177.250	4.912.1177.250

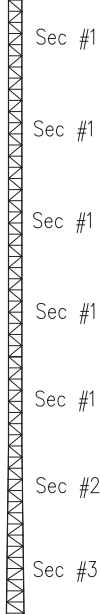
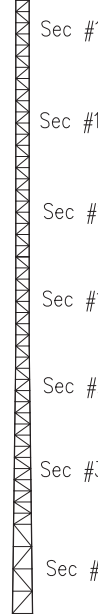
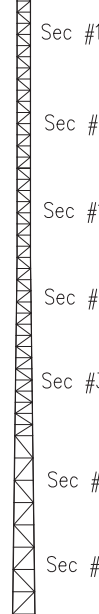
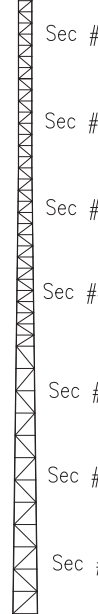
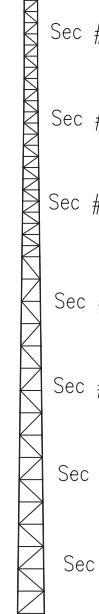
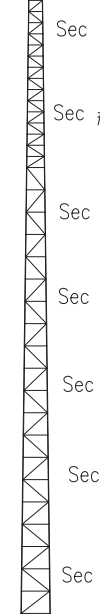
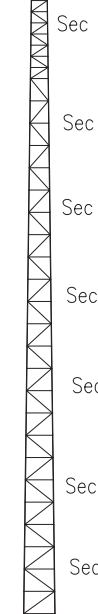
Model Designation:		W020	W040	W060	W080	W100	W200	W300
Part Number:		5.640.0020.070	5.640.0040.070	5.640.0060.070	5.640.0080.070	5.640.0100.070	5.640.0200.070	5.640.0300.070
								
Allowable antenna area in ft <sup>2</sup> at:	CSA-S37-01 350/450/550 Pa Wind 25mm ice	--/--	--/--	--/--	--/--	66/48/38	90/64/48	118/86/66
Shipping Weight (lbs)		1,985	2,235	2,585	2,927	3,218	3,597	4,044

\*Assumptions: Projected areas (PA) shown are bare; a 1.5 multiplier used for iced area; loads centrally located and balanced at tower top; considers step-pegs, safety cable, and one 1/2" tx line per 10 sq.ft.; "--" indicates tower failure.  
 \*\*Round antennas include omnis, dipoles, dishes with radomes, etc. Antennas where wind hits a round surface. Flat Antennas include flat panels, dishes without radomes and cameras, where wind hits a flat surface.

## Common Accessories

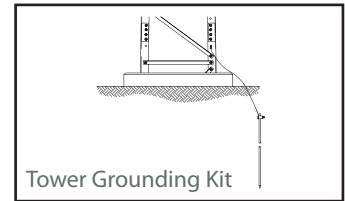

Accessory:	W020	W040	W060	W080	W100	W200	W300
<b>Cable Safety Climb Kits</b> <i>no slider</i>	4.99.0300.000	4.99.0300.000	4.99.0300.000	4.99.0300.000	4.99.0300.000	4.99.0300.000	4.99.0300.000
<b>Lighting Kit</b>	4.942.1024.150	4.942.1024.150	4.942.1024.150	4.942.1024.150	4.942.1024.150	4.942.1024.150	4.942.1024.150
<b>Anti-Climb Shield Kits</b>	4.936.0026.003	4.936.0026.004	4.936.0026.005	4.936.0026.006	4.936.0026.007	4.936.0026.008	4.936.0026.009
<b>Tower Grounding Kit</b> <i>basic, single leg</i>	4.912.1177.125	4.912.1177.150	4.912.1177.175	4.912.1177.175	4.912.1177.175	4.912.1177.225	4.912.1177.225



Model Designation:		W400	W500	W600	W700	W800	W900
Part Number:		5.640.0400.070	5.640.0500.070	5.640.0600.070	5.640.0700.070	5.640.0800.070	5.640.0900.070
Allowable antenna area in ft <sup>2</sup> at:*	CSA-S37-01 350/450/550 Pa Wind 25mm ice	148/108/80	172/128/100	166/126/100	242/172/126	230/166/126	224/164/126
Shipping Weight (lbs)		4,443	4,874	5,283	5,793	6,320	6,740

\*Assumptions: Projected areas (PA) shown are bare; a 1.5 multiplier used for iced area; loads centrally located and balanced at tower top; considers step-pegs, safety cable, and one 1/2" tx line per 10 sq.ft.; "-" indicates tower failure.  
\*Round antennas include omnis, dipoles, dishes with radomes, etc. Antennas where wind hits a round surface. Flat Antennas include flat panels, dishes without radomes and cameras, where wind hits a flat surface.

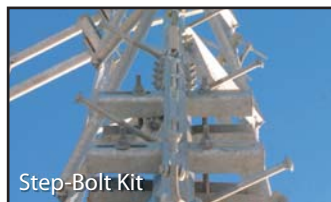
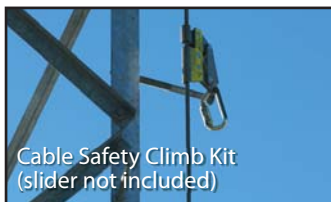
## Common Accessories



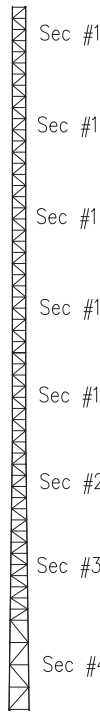
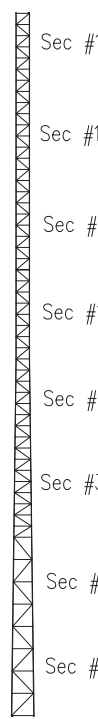
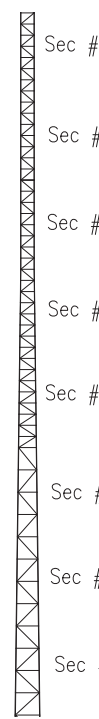
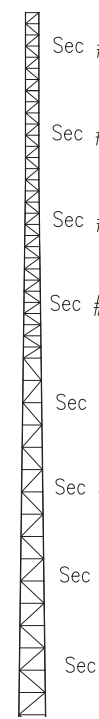
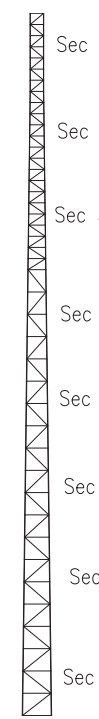
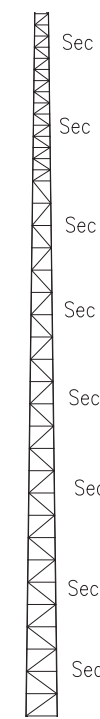



Accessory:	W400	W500	W600	W700	W800	W900
<b>Cable Safety Climb Kits</b> <i>no slider</i>	4.99.0300.000	4.99.0300.000	4.99.0300.000	4.99.0300.000	4.99.0300.000	4.99.0300.000
<b>Lighting Kit</b>	4.942.1024.150	4.942.1024.150	4.942.1024.150	4.942.1024.150	4.942.1024.150	4.942.1024.150
<b>Anti-Climb Shield Kits</b>	4.936.0026.010	4.936.0026.011	4.936.0026.012	4.936.0026.013	4.936.0026.014	4.936.0026.015
<b>Tower Grounding Kit</b> <i>basic, single leg</i>	4.912.1177.225	4.912.1177.250	4.912.1177.250	4.912.1177.250	4.912.1177.250	4.912.1177.250

Model Designation:		W020	W040	W060	W080	W100	W200	W300	
Part Number:		5.640.0020.080	5.640.0040.080	5.640.0060.080	5.640.0080.080	5.640.0100.080	5.640.0200.080	5.640.0300.080	
									
Allowable antenna area in ft <sup>2</sup> at:*		CSA-S37-01 350/450/550 Pa Wind 25mm ice	--/--	--/--	--/--	--/--	64/46/36	86/60/46	114/80/58
Shipping Weight (lbs)		2,520	2,795	3,155	3,438	3,816	4,255	4,760	

\*Assumptions: Projected areas (PA) shown are bare; a 1.5 multiplier used for iced area; loads centrally located and balanced at tower top; considers step-pegs, safety cable, and one 1/2" tx line per 10 sq.ft.; "--" indicates tower failure.  
\*Round antennas include omnis, dipoles, dishes with radomes, etc. Antennas where wind hits a round surface. Flat Antennas include flat panels, dishes without radomes and cameras, where wind hits a flat surface.

## Common Accessories



Accessory:	W020	W040	W060	W080	W100	W200	W300
<b>Cable Safety Climb Kits</b> <i>no slider</i>	4.99.0300.000	4.99.0300.000	4.99.0300.000	4.99.0300.000	4.99.0300.000	4.99.0300.000	4.99.0300.000
<b>Lighting Kit</b>	4.942.1024.150	4.942.1024.150	4.942.1024.150	4.942.1024.150	4.942.1024.150	4.942.1024.150	4.942.1024.150
<b>Anti-Climb Shield Kits</b>	4.936.0026.004	4.936.0026.005	4.936.0026.006	4.936.0026.007	4.936.0026.008	4.936.0026.009	4.936.0026.010
<b>Tower Grounding Kit</b> <i>basic, single leg</i>	4.912.1177.150	4.912.1177.175	4.912.1177.175	4.912.1177.175	4.912.1177.225	4.912.1177.225	4.912.1177.225

Model Designation:		W400	W500	W600	W700	W800		
Part Number:		5.640.0400.080	5.640.0500.080	5.640.0600.080	5.640.0700.080	5.640.0800.080		
		 Sec #4 Sec #5 Sec #6 Sec #7 Sec #8 Sec #9 Sec #10 Sec #11	 Sec #5 Sec #6 Sec #7 Sec #8 Sec #9 Sec #10 Sec #11 Sec #12	 Sec #6 Sec #7 Sec #8 Sec #9 Sec #10 Sec #11 Sec #12 Sec #13	 Sec #7 Sec #8 Sec #9 Sec #10 Sec #11 Sec #12 Sec #13 Sec #14	 Sec #8 Sec #9 Sec #10 Sec #11 Sec #12 Sec #13 Sec #14 Sec #15		
Allowable antenna area in ft <sup>2</sup> at:*	CSA-S37-01 350/450/550 Pa Wind 25mm ice	144/102/76	166/124/96	160/122/98	232/164/120	222/160/120		
Shipping Weight (lbs)		5,257	5,742	6,265	6,828	7,336		

\*Assumptions: Projected areas (PA) shown are bare; a 1.5 multiplier used for iced area; loads centrally located and balanced at tower top; considers step-pegs, safety cable, and one 1/2" tx line per 10 sq.ft.; "-" indicates tower failure.  
\*Round antennas include omnis, dipoles, dishes with radomes, etc. Antennas where wind hits a round surface. Flat Antennas include flat panels, dishes without radomes and cameras, where wind hits a flat surface.

## Common Accessories

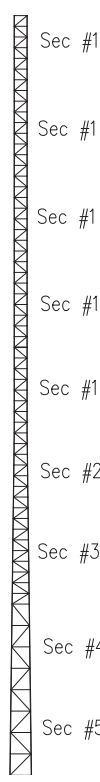

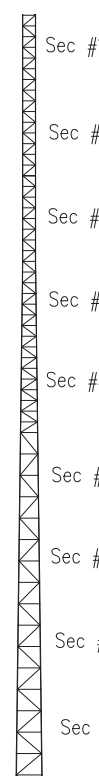
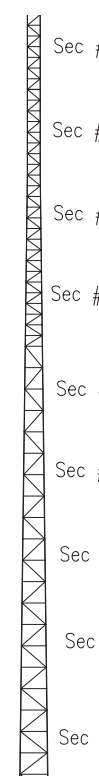
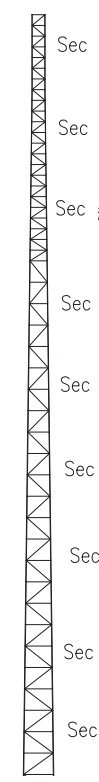
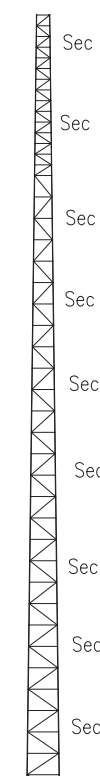
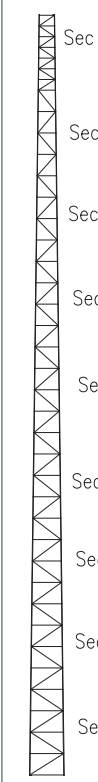

Accessory:	W400	W500	W600	W700	W800		
<b>Cable Safety Climb Kits</b> <i>no slider</i>	4.99.0300.000	4.99.0300.000	4.99.0300.000	4.99.0300.000	4.99.0300.000		
<b>Lighting Kit</b>	4.942.1024.150	4.942.1024.150	4.942.1024.150	4.942.1024.150	4.942.1024.150		
<b>Anti-Climb Shield Kits</b>	4.936.0026.011	4.936.0026.012	4.936.0026.013	4.936.0026.014	4.936.0026.015		
<b>Tower Grounding Kit</b> <i>basic, single leg</i>	4.912.1177.250	4.912.1177.250	4.912.1177.250	4.912.1177.250	4.912.1177.250		

Model Designation:	W020	W040	W060	W080	W100	W200	W300	
Part Number:	5.640.0020.090	5.640.0040.090	5.640.0060.090	5.640.0080.090	5.640.0100.090	5.640.0200.090	5.640.0300.090	
								
Allowable antenna area in ft <sup>2</sup> *	CSA-S37-01 350/450/550 Pa Wind 25mm ice	--/--	--/--	--/--	--/--	62/46/34	84/58/46	112/78/56
Shipping Weight (lbs)	3,202	3,485	3,710	4,036	4,474	4,971	5,573	

\*Assumptions: Projected areas (PA) shown are bare; a 1.5 multiplier used for iced area; loads centrally located and balanced at tower top; considers step-pegs, safety cable, and one 1/2" tx line per 10 sq.ft.; "--" indicates tower failure.  
 \*\*Round antennas include omnis, dipoles, dishes with radomes, etc. Antennas where wind hits a round surface. Flat Antennas include flat panels, dishes without radomes and cameras, where wind hits a flat surface.

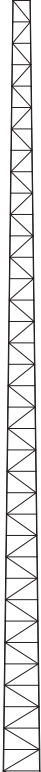
## Common Accessories

Accessory:	W020	W040	W060	W080	W100	W200	W300
<b>Cable Safety Climb Kits</b> <i>no slider</i>	4.99.0300.000	4.99.0300.000	4.99.0300.000	4.99.0300.000	4.99.0300.000	4.99.0300.000	4.99.0300.000
<b>Lighting Kit</b>	4.942.1024.150	4.942.1024.150	4.942.1024.150	4.942.1024.150	4.942.1024.150	4.942.1024.150	4.942.1024.150
<b>Anti-Climb Shield Kits</b>	4.936.0026.005	4.936.0026.006	4.936.0026.007	4.936.0026.008	4.936.0026.009	4.936.0026.010	4.936.0026.011
<b>Tower Grounding Kit</b> <i>basic, single leg</i>	4.912.1177.175	4.912.1177.175	4.912.1177.175	4.912.1177.225	4.912.1177.225	4.912.1177.225	4.912.1177.250

Model Designation:		W400	W500	W600	W700			
Part Number:		5.640.0400.090	5.640.0500.090	5.640.0600.090	5.640.0700.090			
		 <p>Sec #4 Sec #5 Sec #6 Sec #7 Sec #8 Sec #9 Sec #10 Sec #11 Sec #12</p>	 <p>Sec #5 Sec #6 Sec #7 Sec #8 Sec #9 Sec #10 Sec #11 Sec #12 Sec #13</p>	 <p>Sec #6 Sec #7 Sec #8 Sec #9 Sec #10 Sec #11 Sec #12 Sec #13 Sec #14</p>	 <p>Sec #7 Sec #8 Sec #9 Sec #10 Sec #11 Sec #12 Sec #13 Sec #14 Sec #15</p>			
Allowable antenna area in ft <sup>2</sup> *	CSA-S37-01 350/450/550 Pa Wind 25mm ice	138/98/74	162/120/94	156/120/96	224/156/114			
Shipping Weight (lbs)		6,124	6,724	7,300	7,845			

\*Assumptions: Projected areas (PA) shown are bare; a 1.5 multiplier used for iced area; loads centrally located and balanced at tower top; considers step-pegs, safety cable, and one 1/2" tx line per 10 sq.ft.; "-" indicates tower failure.  
\*Round antennas include omnis, dipoles, dishes with radomes, etc. Antennas where wind hits a round surface. Flat Antennas include flat panels, dishes without radomes and cameras, where wind hits a flat surface.

## Common Accessories

Accessory:	W400	W500	W600	W700			
<b>Cable Safety Climb Kits</b> <i>no slider</i>	4.99.0300.000	4.99.0300.000	4.99.0300.000	4.99.0300.000			
<b>Lighting Kit</b>	4.942.1024.150	4.942.1024.150	4.942.1024.150	4.942.1024.150			
<b>Anti-Climb Shield Kits</b>	4.936.0026.012	4.936.0026.013	4.936.0026.014	4.936.0026.015			
<b>Tower Grounding Kit</b> <i>basic, single leg</i>	4.912.1177.250	4.912.1177.250	4.912.1177.250	4.912.1177.250			

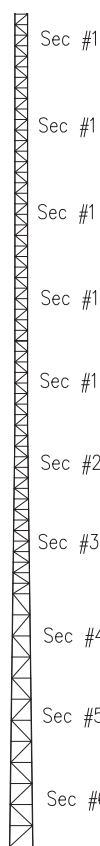
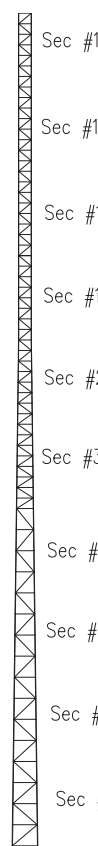
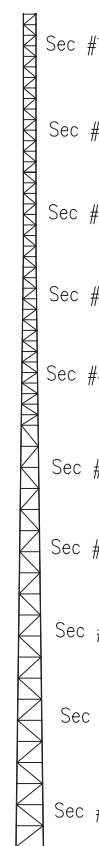
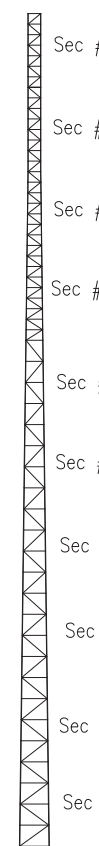
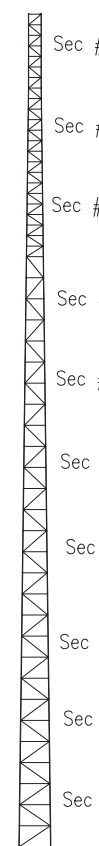
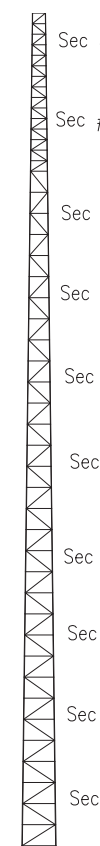
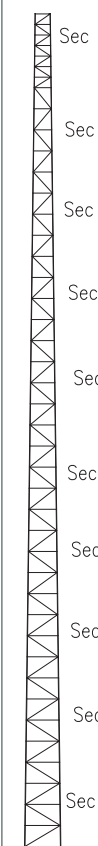

Model Designation:		W020	W040	W060	W080	W100	W200	W300
Part Number:		5.640.0020.100	5.640.0040.100	5.640.0060.100	5.640.0080.100	5.640.0100.100	5.640.0200.100	5.640.0300.100
								
Allowable antenna area in ft <sup>2</sup> *	CSA-S37-01 350/450/550 Pa Wind 25mm ice	--/--	--/--	--/--	--/--	60/46/32	80/56/46	108/74/52
Shipping Weight (lbs)		3,795	4,035	4,315	4,694	5,190	5,784	6,440

\*Assumptions: Projected areas (PA) shown are bare; a 1.5 multiplier used for iced area; loads centrally located and balanced at tower top; considers step-pegs, safety cable, and one 1/2" tx line per 10 sq.ft.; "--" indicates tower failure.  
 \*Round antennas include omnis, dipoles, dishes with radomes, etc. Antennas where wind hits a round surface. Flat Antennas include flat panels, dishes without radomes and cameras, where wind hits a flat surface.

## Common Accessories

Accessory:	W020	W040	W060	W080	W100	W200	W300
<b>Cable Safety Climb Kits</b> <i>no slider</i>	4.99.0300.000	4.99.0300.000	4.99.0300.000	4.99.0300.000	4.99.0300.000	4.99.0300.000	4.99.0300.000
<b>Lighting Kit</b>	4.942.1024.150	4.942.1024.150	4.942.1024.150	4.942.1024.150	4.942.1024.150	4.942.1024.150	4.942.1024.150
<b>Anti-Climb Shield Kits</b>	4.936.0026.006	4.936.0026.007	4.936.0026.008	4.936.0026.009	4.936.0026.010	4.936.0026.011	4.936.0026.012
<b>Tower Grounding Kit</b> <i>basic, single leg</i>	4.912.1177.175	4.912.1177.175	4.912.1177.225	4.912.1177.225	4.912.1177.225	4.912.1177.250	4.912.1177.250









Model Designation:		W400	W500	W600				
Part Number:		5.640.0400.100	5.640.0500.100	5.640.0600.100				
		 <p>Sec #4 Sec #5 Sec #6 Sec #7 Sec #8 Sec #9 Sec #10 Sec #11 Sec #12 Sec #13</p>	 <p>Sec #5 Sec #6 Sec #7 Sec #8 Sec #9 Sec #10 Sec #11 Sec #12 Sec #13 Sec #14</p>	 <p>Sec #6 Sec #7 Sec #8 Sec #9 Sec #10 Sec #11 Sec #12 Sec #13 Sec #14 Sec #15</p>				
Allowable antenna area in ft <sup>2</sup> *	CSA-S37-01 350/450/550 Pa Wind 25mm ice	134/96/70	158/118/92	154/116/94				
Shipping Weight (lbs)		7,106	7,758	8,317				

\*Assumptions: Projected areas (PA) shown are bare; a 1.5 multiplier used for iced area; loads centrally located and balanced at tower top; considers step-pegs, safety cable, and one 1/2" tx line per 10 sq.ft.; "-" indicates tower failure.  
\*Round antennas include omnis, dipoles, dishes with radomes, etc. Antennas where wind hits a round surface. Flat Antennas include flat panels, dishes without radomes and cameras, where wind hits a flat surface.

## Common Accessories

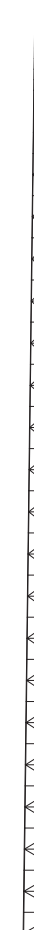
Accessory:	W400	W500	W600				
<b>Cable Safety Climb Kits</b> <i>no slider</i>	4.99.0300.000	4.99.0300.000	4.99.0300.000				
<b>Lighting Kit</b>	4.942.1024.150	4.942.1024.150	4.942.1024.150				
<b>Anti-Climb Shield Kits</b>	4.936.0026.013	4.936.0026.014	4.936.0026.015				
<b>Tower Grounding Kit</b> <i>basic, single leg</i>	4.912.1177.250	4.912.1177.250	4.912.1177.250				

Model Designation:	W040	W060	W080	W100	W200	W300	W400	
Part Number:	5.640.0040.110	5.640.0060.110	5.640.0080.110	5.640.0100.110	5.640.0200.110	5.640.0300.110	5.640.0400.110	
	 Sec #1 Sec #1 Sec #1 Sec #1 Sec #2 Sec #3 Sec #4 Sec #5 Sec #6 Sec #7 Sec #8	 Sec #1 Sec #1 Sec #1 Sec #2 Sec #3 Sec #4 Sec #5 Sec #6 Sec #7 Sec #8 Sec #9	 Sec #1 Sec #1 Sec #2 Sec #3 Sec #4 Sec #5 Sec #6 Sec #7 Sec #8 Sec #9 Sec #10	 Sec #1 Sec #2 Sec #3 Sec #4 Sec #5 Sec #6 Sec #7 Sec #8 Sec #9 Sec #10 Sec #11	 Sec #2 Sec #3 Sec #4 Sec #5 Sec #6 Sec #7 Sec #8 Sec #9 Sec #10 Sec #11 Sec #12	 Sec #3 Sec #4 Sec #5 Sec #6 Sec #7 Sec #8 Sec #9 Sec #10 Sec #11 Sec #12 Sec #13	 Sec #4 Sec #5 Sec #6 Sec #7 Sec #8 Sec #9 Sec #10 Sec #11 Sec #12 Sec #13 Sec #14	
Allowable antenna area in ft <sup>2</sup> *	CSA-S37-01 350/450/550 Pa Wind 25mm ice	--/--	--/--	--/--	58/44/30	78/54/44	104/72/52	130/92/68
Shipping Weight (lbs)	5,085	5,409	6,003	6,651	7,422	8,140	8,140	

\*Assumptions: Projected areas (PA) shown are bare; a 1.5 multiplier used for iced area; loads centrally located and balanced at tower top; considers step-pegs, safety cable, and one 1/2" tx line per 10 sq.ft.; "--" indicates tower failure.  
 \*\*Round antennas include omnis, dipoles, dishes with radomes, etc. Antennas where wind hits a round surface. Flat Antennas include flat panels, dishes without radomes and cameras, where wind hits a flat surface.

## Common Accessories



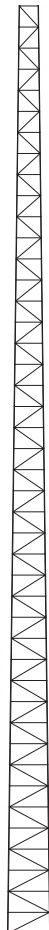



Accessory:	W040	W060	W080	W100	W200	W300	W400
<b>Cable Safety Climb Kits</b> <i>no slider</i>	4.99.0305.000	4.99.0305.000	4.99.0305.000	4.99.0305.000	4.99.0305.000	4.99.0305.000	4.99.0305.000
<b>Lighting Kit</b>	4.942.1024.150	4.942.1024.150	4.942.1024.150	4.942.1024.150	4.942.1024.150	4.942.1024.150	4.942.1024.150
<b>Anti-Climb Shield Kits</b>	4.936.0026.008	4.936.0026.009	4.936.0026.010	4.936.0026.011	4.936.0026.012	4.936.0026.013	4.936.0026.014

Model Designation:		W500					
Part Number:		5.640.0500.110					
		 <p>Sec #5</p> <p>Sec #6</p> <p>Sec #7</p> <p>Sec #8</p> <p>Sec #9</p> <p>Sec #10</p> <p>Sec #11</p> <p>Sec #12</p> <p>Sec #13</p> <p>Sec #14</p> <p>Sec #15</p>					
Allowable antenna area in ft <sup>2</sup> *	CSA-S37-01 350/450/550 Pa Wind 25mm ice	154/114/90					
Shipping Weight (lbs)		8,775					

\*Assumptions: Projected areas (PA) shown are bare; a 1.5 multiplier used for iced area; loads centrally located and balanced at tower top; considers step-pegs, safety cable, and one 1/2" tx line per 10 sq.ft.; "-" indicates tower failure.  
\*Round antennas include omnis, dipoles, dishes with radomes, etc. Antennas where wind hits a round surface. Flat Antennas include flat panels, dishes without radomes and cameras, where wind hits a flat surface.

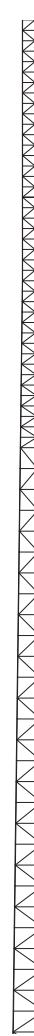
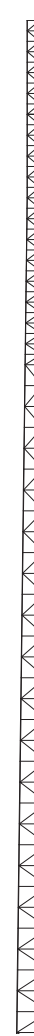
## Common Accessories

Accessory:	W500						
<b>Cable Safety Climb Kits</b> <small>no slider</small>	4.99.0305.000						
<b>Lighting Kit</b>	4.942.1024.150						
<b>Anti-Climb Shield Kits</b>	4.936.0026.015						

Model Designation:	W020	W040	W060	W080	W100	W200	W300	
Part Number:	5.640.0020.120	5.640.0040.120	5.640.0060.120	5.640.0080.120	5.640.0100.120	5.640.0200.120	5.640.0300.120	
	 Sec #1 Sec #1 Sec #1 Sec #1 Sec #1 Sec #2 Sec #3 Sec #4 Sec #5 Sec #6 Sec #7 Sec #8	 Sec #1 Sec #1 Sec #1 Sec #1 Sec #2 Sec #3 Sec #4 Sec #5 Sec #6 Sec #7 Sec #8 Sec #9	 Sec #1 Sec #1 Sec #1 Sec #2 Sec #3 Sec #4 Sec #5 Sec #6 Sec #7 Sec #8 Sec #9 Sec #10	 Sec #1 Sec #1 Sec #2 Sec #3 Sec #4 Sec #5 Sec #6 Sec #7 Sec #8 Sec #9 Sec #10 Sec #11	 Sec #1 Sec #2 Sec #3 Sec #4 Sec #5 Sec #6 Sec #7 Sec #8 Sec #9 Sec #10 Sec #11 Sec #12	 Sec #2 Sec #3 Sec #4 Sec #5 Sec #6 Sec #7 Sec #8 Sec #9 Sec #10 Sec #11 Sec #12 Sec #13	 Sec #3 Sec #4 Sec #5 Sec #6 Sec #7 Sec #8 Sec #9 Sec #10 Sec #11 Sec #12 Sec #13 Sec #14	
Allowable antenna area in ft <sup>2</sup> *	CSA-S37-01 350/450/550 Pa Wind 25mm Ice	--/--	--/--	--/--	--/--	56/42/30	76/52/42	102/70/52
Shipping Weight (lbs)	4,732	5,420	5,795	6,223	6,871	7,633	8,457	

\*Assumptions: Projected areas (PA) shown are bare; a 1.5 multiplier used for iced area; loads centrally located and balanced at tower top; considers step-pegs, safety cable, and one 1/2" tx line per 10 sq.ft.; "--" indicates tower failure.  
 \*\*Round antennas include omnis, dipoles, dishes with radomes, etc. Antennas where wind hits a round surface. Flat Antennas include flat panels, dishes without radomes and cameras, where wind hits a flat surface.

## Common Accessories



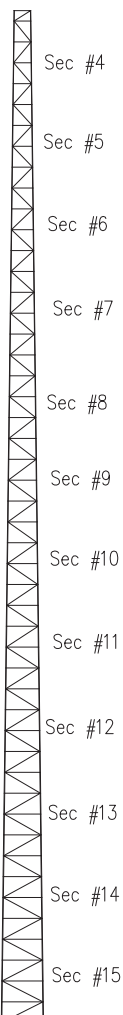

Accessory	S100	H100	H110	S300	S310	S400	S410
<b>Cable Safety Climb Kits</b> <i>no slider</i>	4.99.0305.000	4.99.0305.000	4.99.0305.000	4.99.0305.000	4.99.0305.000	4.99.0305.000	4.99.0305.000
<b>Lighting Kit</b>	4.942.1024.150	4.942.1024.150	4.942.1024.150	4.942.1024.150	4.942.1024.150	4.942.1024.150	4.942.1024.150

Model Designation:		W400					
Part Number:		5.640.0400.120					
							
Allowable antenna area in ft <sup>2</sup> *	CSA-S37-01 350/450/550 Pa Wind 25mm ice	128/90/66					
Shipping Weight (lbs)		9,157					

\*Assumptions: Projected areas (PA) shown are bare; a 1.5 multiplier used for iced area; loads centrally located and balanced at tower top; considers step-pegs, safety cable, and one 1/2" tx line per 10 sq.ft.; "--" indicates tower failure.  
 \*Round antennas include omnis, dipoles, dishes with radomes, etc. Antennas where wind hits a round surface. Flat Antennas include flat panels, dishes without radomes and cameras, where wind hits a flat surface.

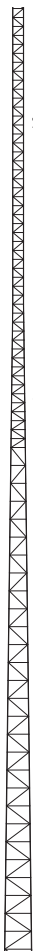
## Common Accessories

Accessory	S500					
<b>Cable Safety Climb Kits</b> <i>no slider</i>	4.99.0305.000					
<b>Lighting Kit</b>	4.942.1024.150					

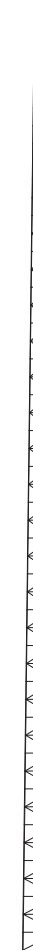
Model Designation:	W020	W040	W060	W080	W100	W200	W300	
Part Number:	5.640.0020.130	5.640.0040.130	5.640.0060.130	5.640.0080.130	5.640.0100.130	5.640.0200.130	5.640.0300.130	
	 Sec #1 Sec #1 Sec #1 Sec #1 Sec #1 Sec #2 Sec #3 Sec #4 Sec #5 Sec #6 Sec #7 Sec #8 Sec #9	 Sec #1 Sec #1 Sec #1 Sec #1 Sec #2 Sec #3 Sec #4 Sec #5 Sec #6 Sec #7 Sec #8 Sec #9 Sec #10	 Sec #1 Sec #1 Sec #1 Sec #2 Sec #3 Sec #4 Sec #5 Sec #6 Sec #7 Sec #8 Sec #9 Sec #10 Sec #11	 Sec #1 Sec #1 Sec #2 Sec #3 Sec #4 Sec #5 Sec #6 Sec #7 Sec #8 Sec #9 Sec #10 Sec #11 Sec #12	 Sec #1 Sec #2 Sec #3 Sec #4 Sec #5 Sec #6 Sec #7 Sec #8 Sec #9 Sec #10 Sec #11 Sec #12 Sec #13	 Sec #2 Sec #3 Sec #4 Sec #5 Sec #6 Sec #7 Sec #8 Sec #9 Sec #10 Sec #11 Sec #12 Sec #13 Sec #14	 Sec #3 Sec #4 Sec #5 Sec #6 Sec #7 Sec #8 Sec #9 Sec #10 Sec #11 Sec #12 Sec #13 Sec #14 Sec #15	
Allowable antenna area in ft <sup>2</sup> *	CSA-S37-01 350/450/550 Pa Wind 25mm ice	--/--	--/--	--/--	--/--	54/42/30	74/52/40	100/68/50
Shipping Weight (lbs)	5390	5886	6,650	7,090	7,853	8,668	9,474	

\*Assumptions: Projected areas (PA) shown are bare; a 1.5 multiplier used for iced area; loads centrally located and balanced at tower top; considers step-pegs, safety cable, and one 1/2" tx line per 10 sq.ft.; "--" indicates tower failure.  
 \*Round antennas include omnis, dipoles, dishes with radomes, etc. Antennas where wind hits a round surface. Flat Antennas include flat panels, dishes without radomes and cameras, where wind hits a flat surface.

## Common Accessories

Accessory	S300	S310	S400	S410	S500	S510	S600
<b>Cable Safety Climb Kits</b> <i>no slider</i>	4.99.0305.000	4.99.0305.000	4.99.0305.000	4.99.0305.000	4.99.0305.000	4.99.0305.000	4.99.0305.000
<b>Lighting Kit</b>	4.942.1024.150	4.942.1024.150	4.942.1024.150	4.942.1024.150	4.942.1024.150	4.942.1024.150	4.942.1024.150

# 140' Towers





Model Designation:		W020	W040	W060	W080	W100	W200
Part Number:		5.640.0020.140	5.640.0040.140	5.640.0060.140	5.640.0080.140	5.640.0100.140	5.640.0200.140
Allowable antenna area in ft <sup>2</sup> *	CSA-S37-01 350/450/550 Pa Wind 25mm ice	--/--	--/--	--/--	--/--	54/40/30	74/52/40
Shipping Weight (lbs)		6106	6700	7,595	8,072	8,887	9,685

\*Assumptions: Projected areas (PA) shown are bare; a 1.5 multiplier used for iced area; loads centrally located and balanced at tower top; considers step-pegs, safety cable, and one 1/2" tx line per 10 sq.ft.; "--" indicates tower failure.  
 \*Round antennas include omnis, dipoles, dishes with radomes, etc. Antennas where wind hits a round surface. Flat Antennas include flat panels, dishes without radomes and cameras, where wind hits a flat surface.

## Common Accessories

Accessory	S300	S310	S400	S410	S500	S510
<b>Cable Safety Climb Kits</b> <i>no slider</i>	4.99.0305.000	4.99.0305.000	4.99.0305.000	4.99.0305.000	4.99.0305.000	4.99.0305.000
<b>Lighting Kit</b>	4.942.1024.150	4.942.1024.150	4.942.1024.150	4.942.1024.150	4.942.1024.150	4.942.1024.150

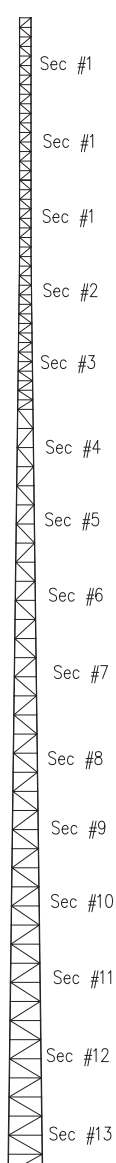
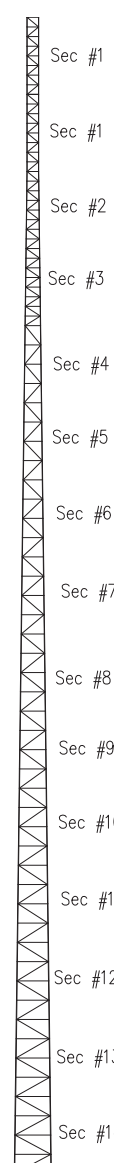
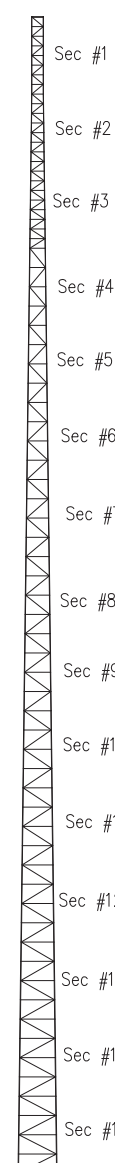

Model Designation:		W060	W080	W100			
Part Number:		5.640.0060.150	5.640.0080.150	5.640.0100.150			
		 <p>Sec #1 Sec #1 Sec #1 Sec #2 Sec #3 Sec #4 Sec #5 Sec #6 Sec #7 Sec #8 Sec #9 Sec #10 Sec #11 Sec #12 Sec #13</p>	 <p>Sec #1 Sec #1 Sec #2 Sec #3 Sec #4 Sec #5 Sec #6 Sec #7 Sec #8 Sec #9 Sec #10 Sec #11 Sec #12 Sec #13 Sec #14</p>	 <p>Sec #1 Sec #2 Sec #3 Sec #4 Sec #5 Sec #6 Sec #7 Sec #8 Sec #9 Sec #10 Sec #11 Sec #12 Sec #13 Sec #14 Sec #15</p>		 <p>Cable Safety Climb Kit – pg 67 (slider not included)</p>	
Allowable antenna area in ft <sup>2</sup> *	CSA-S37-01 350/450/550 Pa Wind 25mm ice	--/--	--/--	52/40/30			
Shipping Weight (lbs)		8,580	9,106	9,904		 <p>Step-Bolt Kit – pg 59</p>	

\*Assumptions: Projected areas (PA) shown are bare; a 1.5 multiplier used for iced area; loads centrally located and balanced at tower top; considers step-pegs, safety cable, and one 1/2" tx line per 10 sq.ft.; "--" indicates tower failure.  
 \*\*Round antennas include omnis, dipoles, dishes with radomes, etc. Antennas where wind hits a round surface. Flat Antennas include flat panels, dishes without radomes and cameras, where wind hits a flat surface.

## Common Accessories

Accessory	W060	W080	W100			
Lighting Kit	4.942.1024.150	4.942.1024.150	4.942.1024.150			

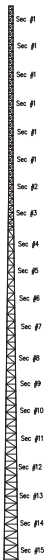

SuperTitan Weld Sections			
Part #	Description	Weight	Image
4.640.0001.000	SuperTitan Weld Section #1: Non-Tapered	220	
4.640.0002.000	SuperTitan Weld Section #2: Tapered	212	
4.640.0003.000	SuperTitan Weld Section #3: Tapered	317	
4.640.0004.000	SuperTitan Weld Section #4: Tapered	383	
4.640.0005.000	SuperTitan Weld Section #5: Tapered	459	
4.640.0006.000	SuperTitan Weld Section #6: Tapered	472	
4.640.0007.000	SuperTitan Weld Section #7: Tapered	509	
4.640.0008.000	SuperTitan Weld Section #8: Tapered	597	
4.640.0009.000	SuperTitan Weld Section #9: Tapered	640	
4.640.0010.000	SuperTitan Weld Section #10: Tapered	714	
4.640.0011.000	SuperTitan Weld Section #11: Tapered	812	
4.640.0012.000	SuperTitan Weld Section #12: Tapered	866	
4.640.0013.000	SuperTitan Weld Section #13: Tapered	981	
4.640.0014.000	SuperTitan Weld Section #14: Tapered	1033	
4.640.0015.000	SuperTitan Weld Section #15: Tapered	1054	

SuperTitan Weld Sections		
Part #	Description	Weight
4.640.0000.002	Template & Tie Rods fits Section #1	450
4.640.0000.003	Template & Tie Rods fits Section #2	452
4.640.0000.004	Template & Tie Rods fits Section #3	557
4.640.0000.005	Template & Tie Rods fits Section #4	558
4.640.0000.006	Template & Tie Rods fits Section #5	560
4.640.0000.007	Template & Tie Rods fits Section #6	667
4.640.0000.008	Template & Tie Rods fits Section #7	669
4.640.0000.009	Template & Tie Rods fits Section #8	671
4.640.0000.010	Template & Tie Rods fits Section #9	689
4.640.0000.011	Template & Tie Rods fits Section #10	690
4.640.0000.012	Template & Tie Rods fits Section #11	692
4.640.0000.013	Template & Tie Rods fits Section #12	694
4.640.0000.014	Template & Tie Rods fits Section #13	696
4.640.0000.015	Template & Tie Rods fits Section #14	698
4.640.0000.016	Template & Tie Rods fits Section #15	700



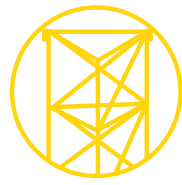
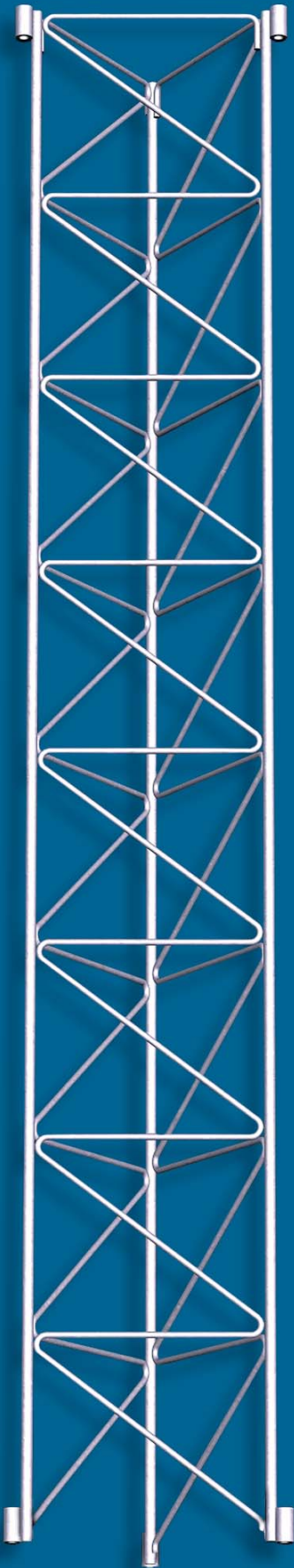

# STG SERIES

A stronger, cost-effective alternative to 45/55/65G series

- .. Just one Trylon section replaces all three Rohn – 45/55/65G!
- .. Solid rod legs, not hollow tubes
- .. Familiar welded S-bracing
- .. Guyed to 350' tall
- .. Bracketed to 120'
- .. Free-standing to 40'
- .. Wind turbine models available

# SuperTITAN Guyed™ vs. Rohn Guyed

A stronger, cost-effective alternative to 45/55/65G series

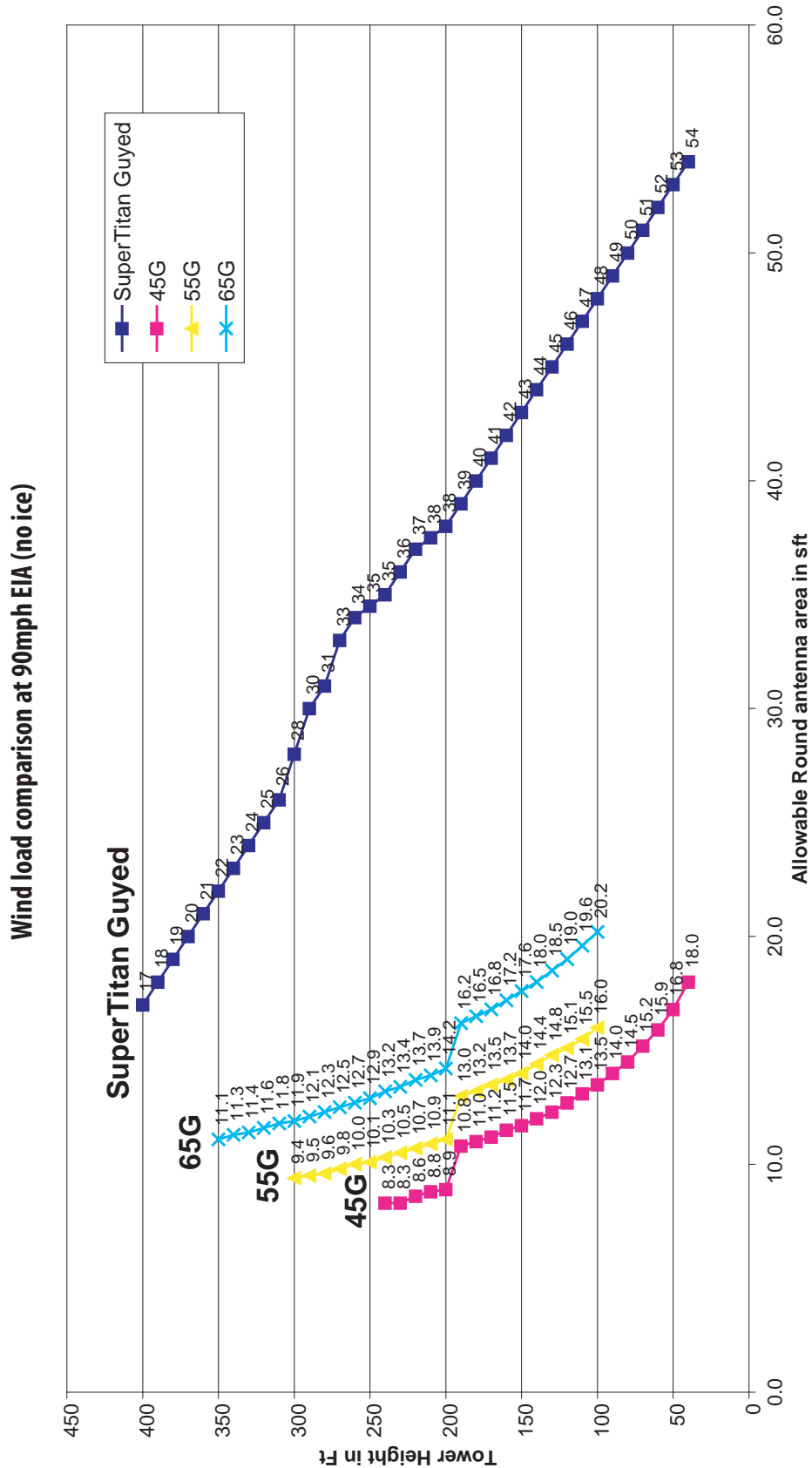

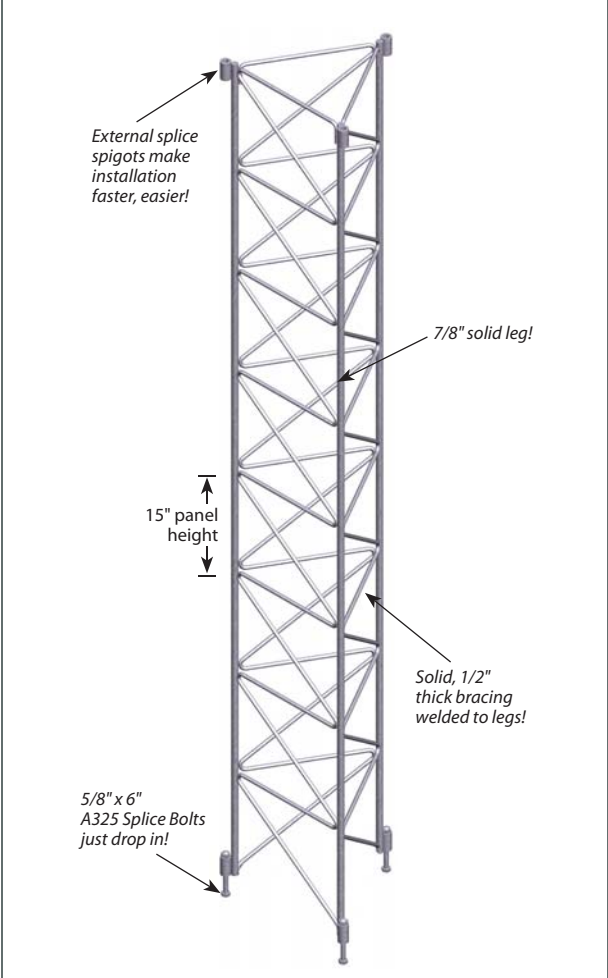
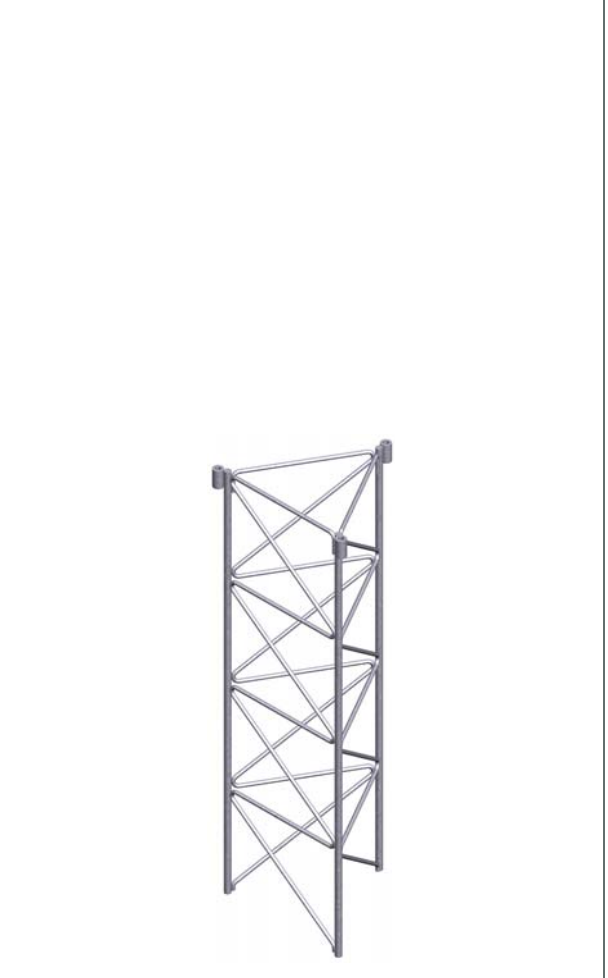
	Standard Section - SuperTITAN Guyed (10' tall, 18" face width, c/w splice hardware)	5' Section - SuperTITAN Guyed (no hardware)
Part Number	4.618.1504.010	4.618.8011.001
Weight	129 lbs [57.8 kg]	63 lbs [28.6 kg]
L"xW"xH"	120x18x18	60x18x18
		

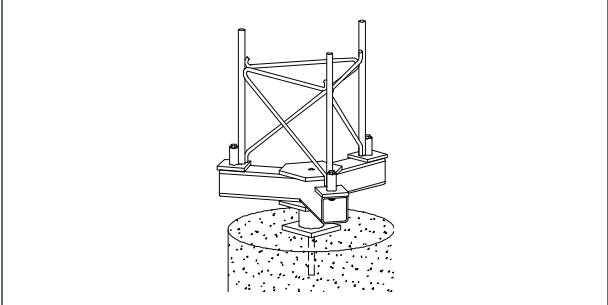
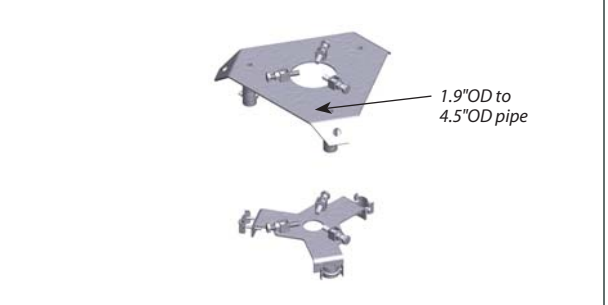
Description:	Star Base Assembly (34.6 kips)	Top Section Adapter (pipe not included)
Part Number	4.618.0602.021	4.618.2711.001
		

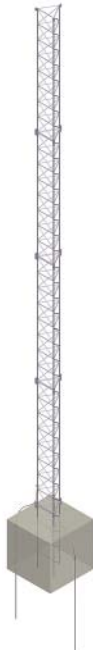
Part Number	Description	CSA Class 1 Wind Load Area in ft <sup>2</sup> at 350/450/550 Pa*	CSA Class 3 Wind Load Area in ft <sup>2</sup> at 350/450/550 Pa*	Ship Weight	L"xW"xH"	Image
4.618.SSTG.010	10' STG SS	115/90/74	146/112/91	311 lbs	120x18x18	
4.618.SSTG.020	20' STG SS	51/39/31	64/50/40	438 lbs	122x30x20	
4.618.SSTG.030	30' STG SS	20/15/10	31/20/16	564 lbs	122x40x20	
4.618.SSTG.040	40' STG SS	10/3/--	12/10/3	691 lbs	122x48x20	

All Self-Supporting Tower Kits come complete with an extra 5' section so that the height in the description is the **actual** overall structure height.

Complete towers include 5' short base for concrete embedment.

4.618.SSTG.040 Illustrated

\*Allowable antenna areas are based on one 1/2" transmission line per 10 square feet; loads being centrally located and balanced over the tower top; all round members; and no ice. For examples of CSA Class 1 vs Class 3, see page 28.

## Foundation Details: Self-Support

Visit [www.trylon.com](http://www.trylon.com) for full installation manual.

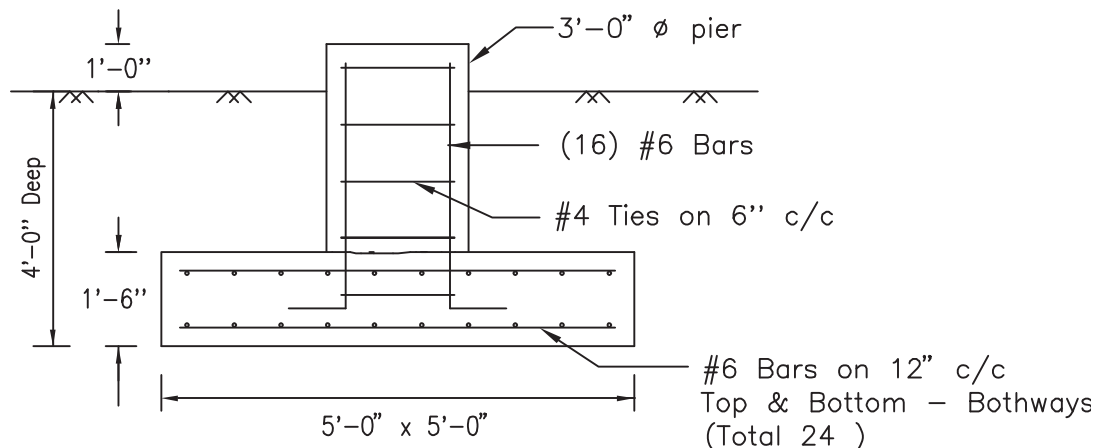

## Tower Selection Guide

Follow the steps below to determine if the bracketed STG can support your antenna load and wind pressure. The key to the strength of the tower is the number of unsupported sections above the building bracket, referred to as 'cantilever length' from here on.

**Step 1:** Select desired tower height (between 20' and 120') and write it in box (A). A

**Step 2:** Choose desired bracket attachment height (between 10' and 90' in increments of 10'). Write the bracket height in box (B). B

**Step 3:** Calculate your cantilever length (C) using the formula to the right. A - B = C

**Step 4:** Using the cantilever length calculated above, check the table below to determine if the tower height you need can support your antennas and wind pressure.

Cantilever Length "C" (above bracket)	Tower Height Range	CSA Class 1 Wind Load Area in ft <sup>2</sup> at 350/450/550 Pa*	CSA Class 3 Wind Load Area in ft <sup>2</sup> at 350/450/550 Pa*
10'	20' to 60'	86/66/50	102/82/66
	70' to 90'	74/60/46	96/75/61
20'	30' to 100'	32/24/20	42/32/25
30'	40' to 110'	18/12/8	23/16/12
40'	50' to 120'	9/5/2	12/9/5

\* Allowable antenna areas are based on one 1/2" transmission line per 10 square feet; loads being centrally located and balanced over the tower top; all round members; and no ice. For examples of CSA Class 1 vs Class 3, see page 28.

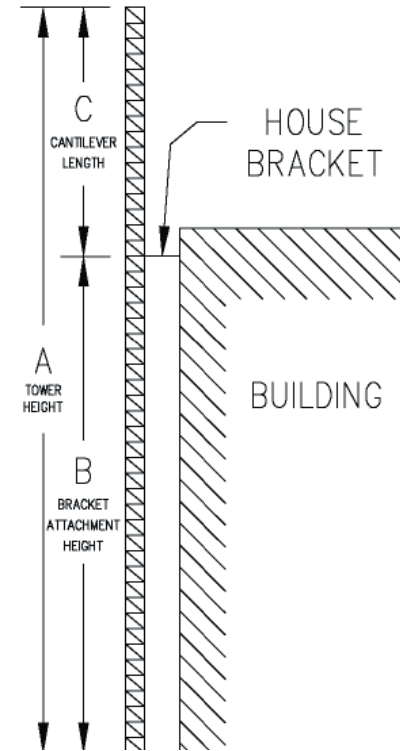

**Step 5:** Order your tower kit using part numbers from the Table below. Height shown is the overall tower height (A).

Part Number	Description	Ship Weight	L"xW"xH"
4.618.BSTG.020	20' STG Bracket	149 lbs	122x48x20
4.618.BSTG.030	30' STG Bracket	278 lbs	122x48x20
4.618.BSTG.040	40' STG Bracket	407 lbs	122x48x20
4.618.BSTG.050	50' STG Bracket	573 lbs	122x56x20
4.618.BSTG.060	60' STG Bracket	702 lbs	122x56x34
4.618.BSTG.070	70' STG Bracket	829 lbs	122x56x34
4.618.BSTG.080	80' STG Bracket	956 lbs	122x56x34
4.618.BSTG.090	90' STG Bracket	1082 lbs	122x56x34
4.618.BSTG.100	100' STG Bracket	1209 lbs	122x56x49
4.618.BSTG.110	110' STG Bracket	1547 lbs	133x56x49
4.618.BSTG.120	120' STG Bracket	1674 lbs	133x56x49

## Foundation Details

Assumes maximum frost depth of 4'

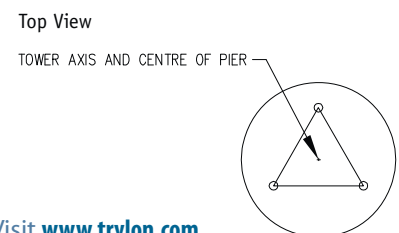
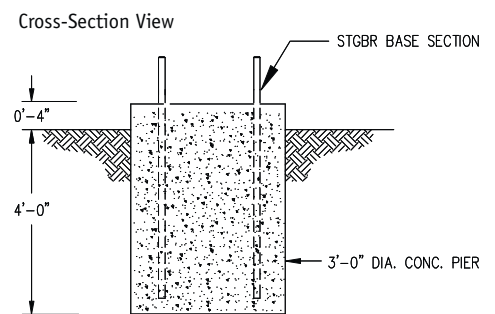

Visit [www.trylon.com](http://www.trylon.com) for full installation manual.

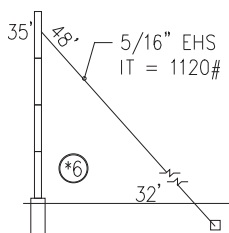
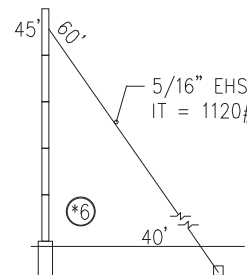
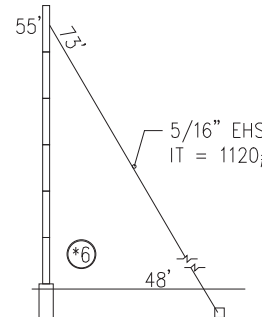
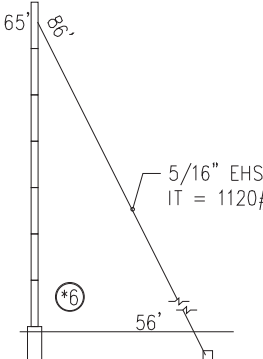
Tower Height:	40'	50'	60'	70'
Part Number	4.618.G000.040	4.618.G000.050	4.618.G000.060	4.618.G000.070
Wind Load Area (ft²) CSA Class 1* 350/450/550 Pa** 10mm ice	Round: 114/90/70 Flat: 76/60/47	Round: 108/86/70 Flat: 72/57/47	Round: 104/82/68 Flat: 69/55/45	Round: 100/78/64 Flat: 67/52/43
Wind Load Area (ft²) CSA Class 3* 350/450/550 Pa** 25mm ice	Round: 142/112/93 Flat: 95/75/62	Round: 136/108/88 Flat: 91/72/59	Round: 130/104/85 Flat: 87/69/57	Round: 127/80/60 Flat: 85/53/40
Ship Weight	921 lbs [415 kg]	1054 lbs [474 kg]	1191 lbs [536 kg]	1324 lbs [596 kg]
Ship Dim. (L"xW"xH")	1@122x60x18 + 1@60x48x30	1@122x60x18 + 1@60x48x30	1@122x60x38 + 1@60x48x38	1@122x60x38 + 1@60x48x38
				

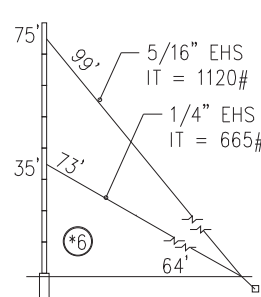
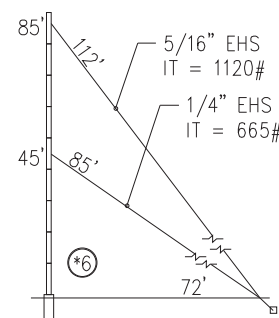
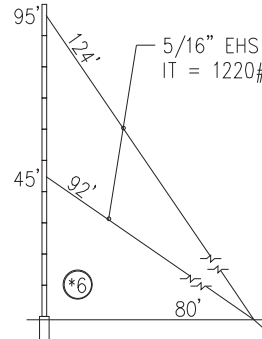
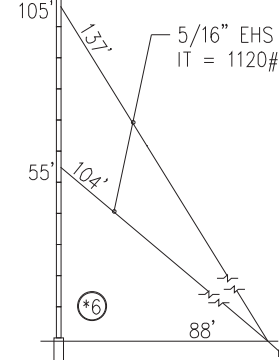
Tower Height:	80'	90'	100'	110'
Part Number	4.618.G000.080	4.618.G000.090	4.618.G000.100	4.618.G000.110
Wind Load Area (ft²) CSA Class 1* 350/450/550 Pa** 10mm ice	Round: 97/75/63 Flat: 65/50/42	Round: 95/74/61 Flat: 63/49/41	Round: 93/72/60 Flat: 62/48/40	Round: 91/70/58 Flat: 61/47/39
Wind Load Area (ft²) CSA Class 3* 350/450/550 Pa** 25mm ice	Round: 125/98/80 Flat: 83/65/53	Round: 122/95/78 Flat: 81/63/52	Round: 120/93/75 Flat: 80/62/50	Round: 116/91/64 Flat: 77/61/43
Ship Weight	1534 lbs [690 kg]	1563 lbs [703 kg]	1860 lbs [837 kg]	2104 lbs [947 kg]
Ship Dim. (L"xW"xH")	1@122x60x38 + 1@60x48x38	1@122x60x38 + 1@60x48x38	1@122x60x38 + 1@60x48x38	1@122x60x60 + 1@60x48x40
				

\*See page 95 for Wind Load Data information.

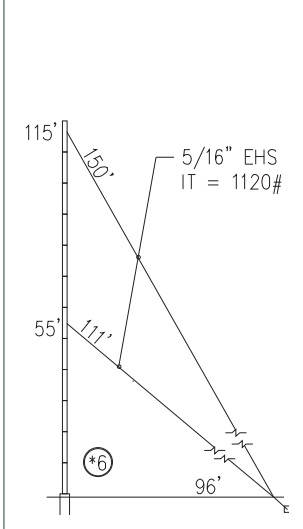
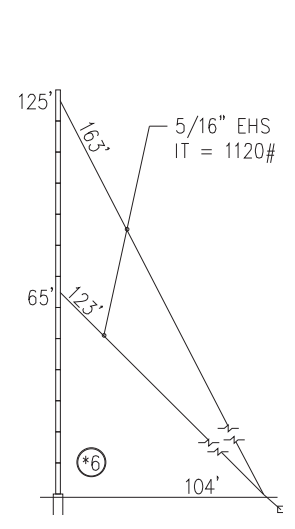
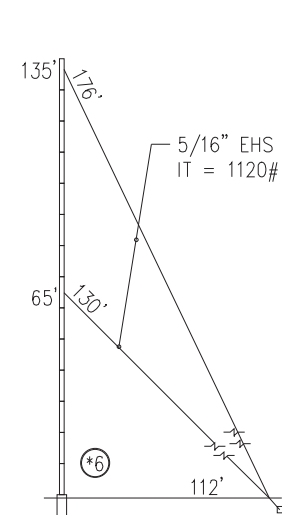
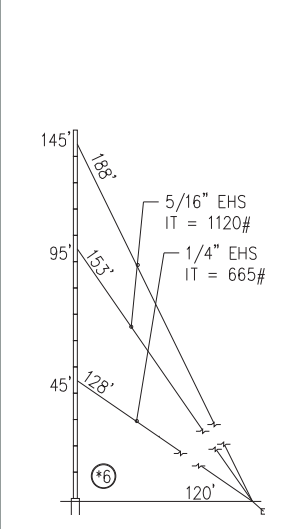

Tower Height:	120'	130'	140'	150'
Part Number	4.618.G000.120	4.618.G000.130	4.618.G000.140	4.618.G000.150
Wind Load Area (ft²) CSA Class 1* 350/450/550 Pa** 10mm ice	Round: 89/69/56 Flat: 59/46/37	Round: 88/68/55 Flat: 59/45/37	Round: 87/67/51 Flat: 58/45/34	Round: 86/64/49 Flat: 57/43/33
Wind Load Area (ft²) CSA Class 3* 350/450/550 Pa** 25mm ice	Round: 108/78/56 Flat: 72/52/37	Round: 100/60/40 Flat: 67/40/27	Round: 80/46/20 Flat: 53/31/13	Round: 102/69/40 Flat: 68/46/27
Ship Weight	2248 lbs [1012 kg]	2391 lbs [1076 kg]	2529 lbs [1138 kg]	2777 lbs [1250 kg]
Ship Dim. (L"xW"xH")	1@122x60x60 + 1@60x48x40	1@122x60x60 + 1@60x48x42	1@122x60x60 + 1@60x48x44	1@122x60x60 + 1@60x48x46
				

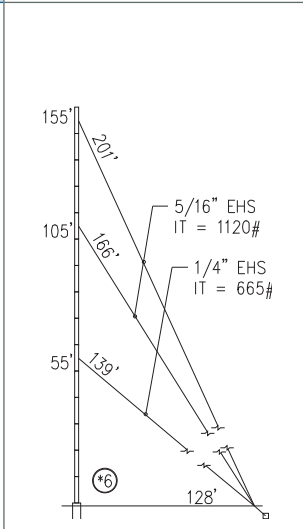
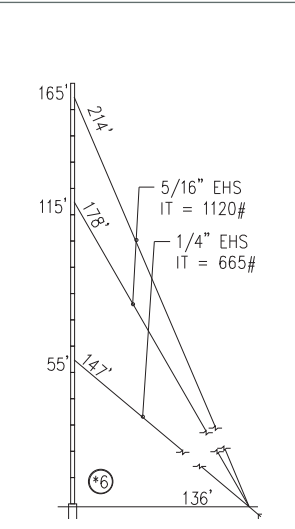
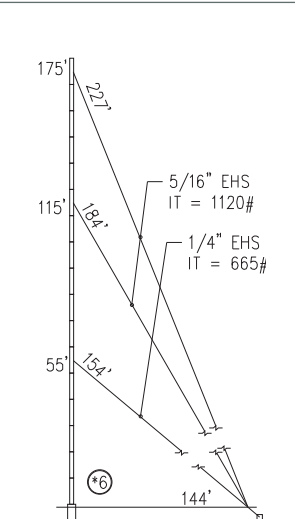
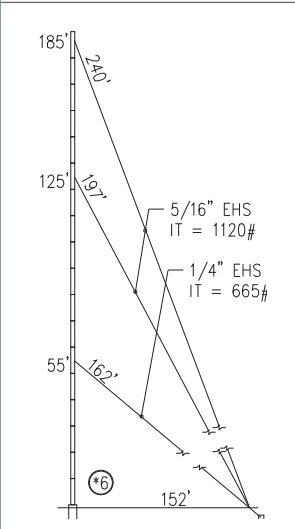
Tower Height:	160'	170'	180'	190'
Part Number	4.618.G000.160	4.618.G000.170	4.618.G000.180	4.618.G000.190
Wind Load Area (ft²) CSA Class 1* 350/450/550 Pa** 10mm ice	Round: 81/60/46 Flat: 54/40/31	Round: 78/52/40 Flat: 52/35/27	Round: 70/48/37 Flat: 47/32/25	Round: 66/45/31 Flat: 44/30/21
Wind Load Area (ft²) CSA Class 3* 350/450/550 Pa** 25mm ice	Round: 80/40/20 Flat: 53/27/13	Round: 80/40/20 Flat: 53/27/13	Round: 60/32/18 Flat: 40/21/12	Round: 62/30/1 Flat: 41/20/1
Ship Weight	2924 lbs [1316 kg]	3070 lbs [1382 kg]	3217 lbs [1448 kg]	3363 lbs [1514 kg]
Ship Dim. (L"xW"xH")	1@122x60x60 + 1@60x48x48	2@122x60x60	2@122x60x60	2@122x60x60
				

\*See page 95 for Wind Load Data information.

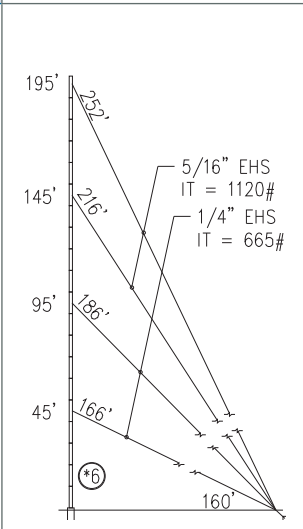
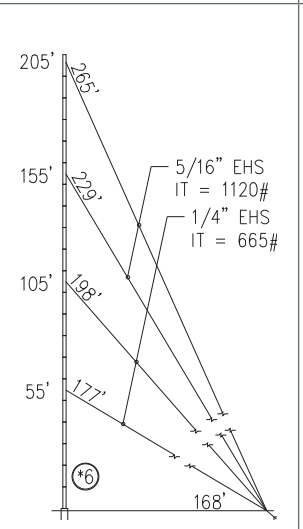
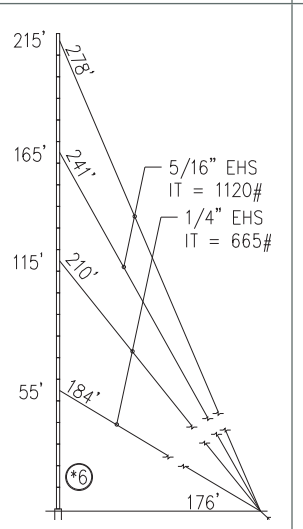
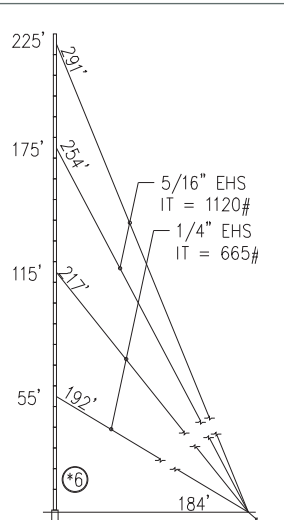
Tower Height:	200'	210'	220'	230'
Part Number	4.618.G000.200	4.618.G000.210	4.618.G000.220	4.618.G000.230
Wind Load Area (ft²) CSA Class 1* 350/450/550 Pa** 10mm ice	Round: 65/45/31 Flat: 43/30/21	Round: 63/43/31 Flat: 42/29/21	Round: 60/41/30 Flat: 40/27/20	Round: 57/40/29 Flat: 38/27/19
Wind Load Area (ft²) CSA Class 3* 350/450/550 Pa** 25mm ice	Round: 50/30/10 Flat: 33/20/7	Round: 10/--/-- Flat: 7/--/--	Round: 10/--/-- Flat: 7/--/--	Round: 10/--/-- Flat: 7/--/--
Ship Weight	3658 lbs [1646 kg]	3912 lbs [1761 kg]	4070 lbs [1832 kg]	4219 lbs [1899 kg]
Ship Dim. (L"xW"xH")	2@122x60x60	2@122x60x60	2@122x60x60	2@122x60x60
				

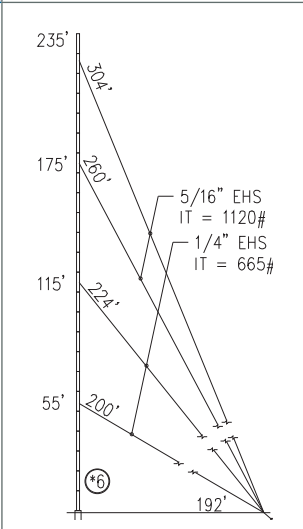
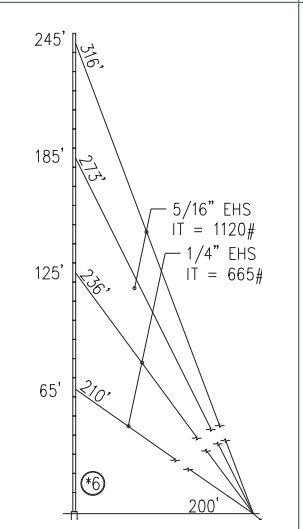
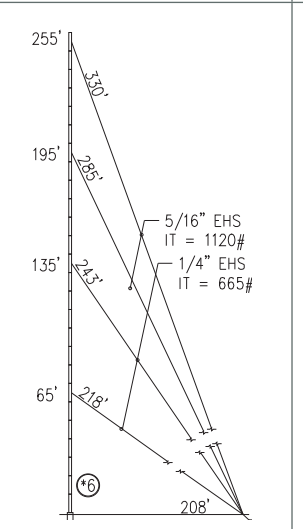
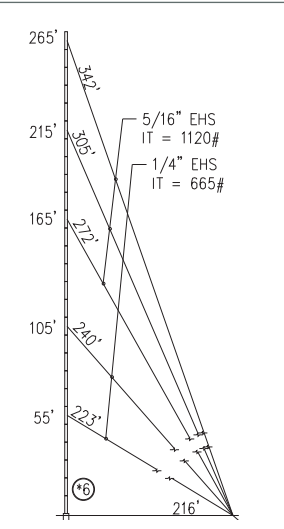
Tower Height:	240'	250'	260'	270'
Part Number	4.618.G000.240	4.618.G000.250	4.618.G000.260	4.618.G000.270
Wind Load Area (ft²) CSA Class 1* 350/450/550 Pa** 10mm ice	Round: 55/39/28 Flat: 37/26/19	Round: 53/30/10 Flat: 35/20/7	Round: 51/35/10 Flat: 34/23/7	Round: 52/32/10 Flat: 35/21/7
Wind Load Area (ft²) CSA Class 3* 350/450/550 Pa** 25mm ice	Round: --/--/-- Flat: --/--/--	Round: --/--/-- Flat: --/--/--	Round: --/--/-- Flat: --/--/--	Round: --/--/-- Flat: --/--/--
Ship Weight	4360 lbs [1962 kg]	4513 lbs [2058 kg]	4671 lbs [2102 kg]	5052 lbs [2274 kg]
Ship Dim. (L"xW"xH")	2@122x60x60	2@122x60x60	2@122x60x60	2@122x60x60
				

\*See page 95 for Wind Load Data information.

Tower Height:	280'	290'	300'	310'
Part Number	4.618.G000.280	4.618.G000.290	4.618.G000.300	4.618.G000.310
Wind Load Area (ft²) CSA Class 1* 350/450/550 Pa** 10mm ice	Round: 53/30/-- Flat: 35/20/--	Round: 51/28/-- Flat: 34/19/--	Round: 49/30/-- Flat: 33/20/--	Round: 50/21/-- Flat: 33/14/--
Wind Load Area (ft²) CSA Class 3* 350/450/550 Pa** 25mm ice	Round: --/--/-- Flat: --/--/--	Round: --/--/-- Flat: --/--/--	Round: --/--/-- Flat: --/--/--	Round: --/--/-- Flat: --/--/--
Ship Weight	5207 lbs [2343 kg]	5363 lbs [2414 kg]	5521 lbs [2485 kg]	5782 lbs [2602 kg]
Ship Dim. (L"xW"xH")	2@122x60x60	2@122x60x60	2@122x60x60	2@122x60x60

Tower Height:	320'	330'	340'	350'
Part Number	4.618.G000.320	4.618.G000.330	4.618.G000.340	4.618.G000.350
Wind Load Area (ft²) CSA Class 1* 350/450/550 Pa** 10mm ice	Round: 49/20/-- Flat: 33/13/--	Round: 20/--/-- Flat: 13/--/--	Round: 10/--/-- Flat: 7/--/--	Round: 10/--/-- Flat: 7/--/--
Wind Load Area (ft²) CSA Class 3* 350/450/550 Pa** 25mm ice	Round: --/--/-- Flat: --/--/--	Round: --/--/-- Flat: --/--/--	Round: --/--/-- Flat: --/--/--	Round: --/--/-- Flat: --/--/--
Ship Weight	5938 lbs [2672 kg]	6292 lbs [2832 kg]	6456 lbs [2905 kg]	6892 lbs [3102 kg]
Ship Dim. (L"xW"xH")	2@122x60x60 + 1@60x48x48	2@122x60x60 + 1@122x60x24	2@122x60x60 + 1@122x60x24	2@122x60x60 + 1@122x60x24
* Assumptions: Projected areas (PA) shown are bare; a 1.5 multiplier used for iced area; loads centrally located and balanced at tower top; considers step-peg, safety cable, and one 1/2" x line per 10 sq.ft.; "--" indicates tower failure. ** For examples of CSA Class 1 vs Class 3, see page 28.				

**STG SERIES** SuperTITAN Guyed™ Kits

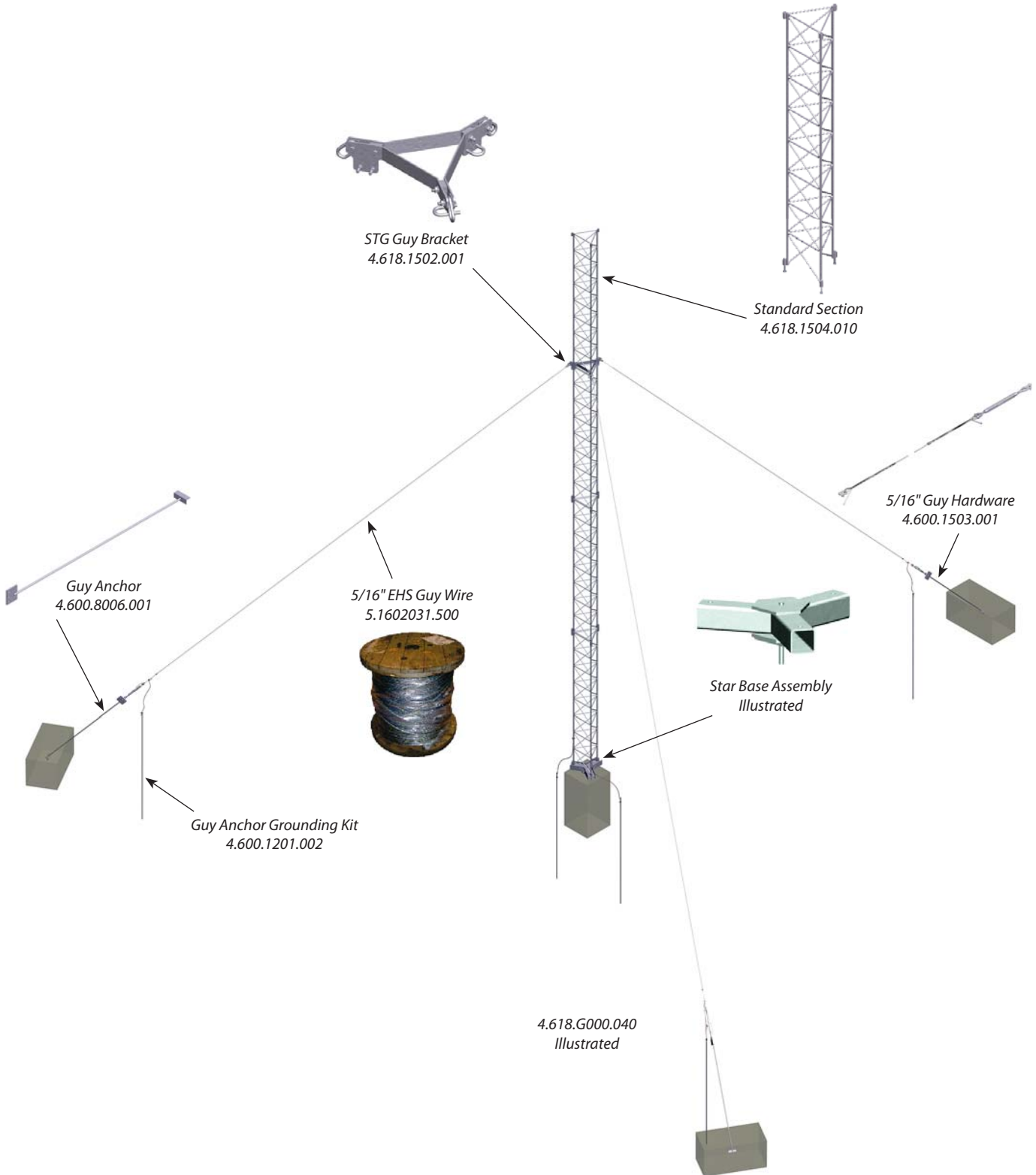

# Concrete Foundation Details STG SERIES

(Normal dry soil)

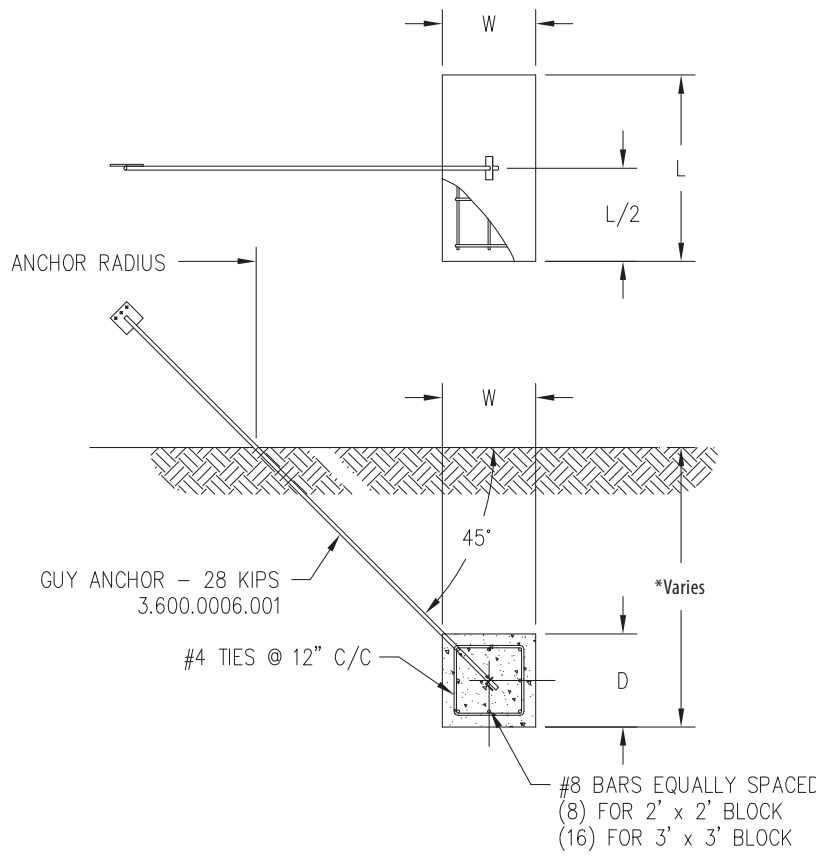
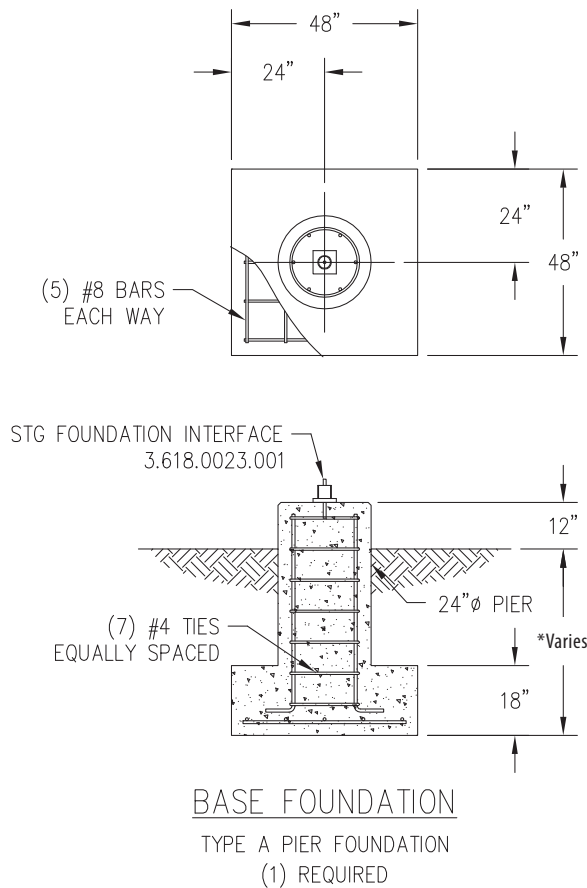

Please email [info@trylon.com](mailto:info@trylon.com) for full installation manual.







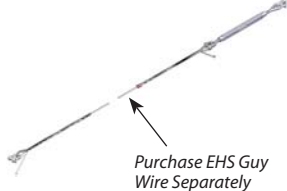

FOUNDATION TYPE	DIMENSIONS				MAX LOAD (LBS)		
	W	D	L	L/2	AXIAL	HORIZ	VERT
B	3'	3'	11'	5.5'	28,000	20,000	20,000
C	3'	3'	8'	4'	21,000	15,000	15,000
D	2'	2'	6'	3'	14,000	10,000	10,000
E	2'	2'	4'	2'	7,000	5,000	5,000

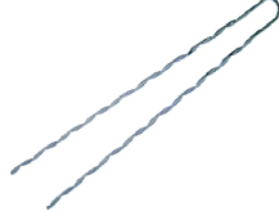
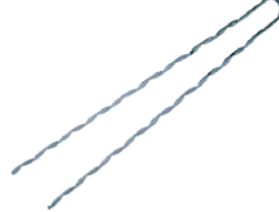
\* Note: Please contact Trylon for frost depth information.

Description:	5/16" x 500' EHS Guy Wire	5/16" x 1000' EHS Guy Wire	1/4" x 500' EHS Guy Wire	1/4" x 1000' EHS Guy Wire
Part Number	5.1602031.500	5.1602031.1000	5.1602030.500	5.1602030.1000
				

Description:	1/4" Guy Hardware	5/16" Guy Hardware	3/8" Thimble (for use with 1/4" and 5/16" EHS)	7/16" Shackle (for use with 1/4" and 5/16" EHS)
Part Number	4.600.1502.001	4.600.1503.001	5.1601650	5.1601600
				

Description:	1/4" Big Grip (for use with 1/4" EHS)	5/16" Big Grip (for use with 5/16" EHS)	Hose Clamp (for 3/16", 1/4", and 5/16" EHS)	1/4" End Sleeve (for use with 1/4" EHS)
Part Number	5.1607047	5.1607048	5.2204020	5.1607077
				

Description:	5/16" End Sleeve (for use with 5/16" EHS)	1/2" x 12" Turnbuckle (for use with 3/16" and 1/4" EHS)	5/8" x 12" Turnbuckle (for use with 5/16" EHS)	1/4" U-Bolt Clip
Part Number	5.1607078	5.1601700	5.1601705	5.1601302
				

**Basic Light Kit (dual obstruction red lights, non-alarmed, steady burning, no photocell, c/w lights, cable, connectors, ty wraps, etc.)**

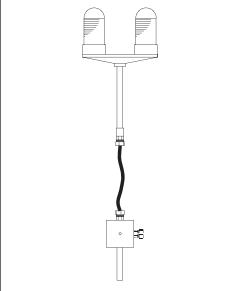
Part Number	Description	Ship Wt. (lbs)*	Image
4.93.0200.150	Basic DOL Light Kit, 0 to 150' towers	60	

\* Packaging includes three pieces: one box with lights only (20"L x 8"W x 10"H), one reel of tech cable (24"OD x 12"H), and one box of all other components (8"L x 8"W x 16"H).

**Light Kit with Photocell (non-alarmed, c/w red lights, cable, connectors, ty wraps, etc.)**

Part Number	Description	Ship Wt. (lbs)	Image
4.93.STGP.150	0-150' DOL Light Kit	90	
4.93.STGP.350	151-350' Beacon Light Kit	200	
4.93.STGP.480	351-480' Beacon Light Kit	300	

**Light Kit with Alarmed Controller and Photocell (c/w red lights, cable, connectors, ty wraps, etc.)**

Part Number	Description	Ship Wt. (lbs)	Image
4.93.STGA.150	0-150' DOL Light Kit	90	
4.93.STGA.350	151-350' Beacon Light Kit	200	
4.93.STGA.480	351-480' Beacon Light Kit	300	



**White Strobe Light Kit (medium intensity, c/w cable, connectors, etc., no mid DOL)**



Part Number	Description	Ship Wt. (lbs)	Image
4.93.STGW.150	STG White Strobe Kit, 0 to 150' towers	157	
4.93.STGW.250	STG White Strobe Kit, 151' to 250' towers	203	



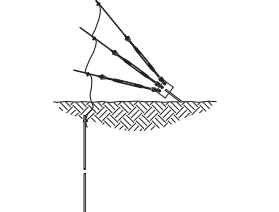

**48VDC LED Light Kit with Photocell (ideal for sites powered by solar energy)**

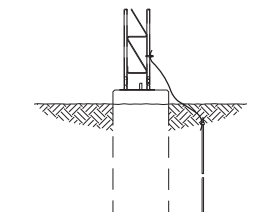
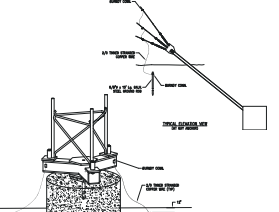
Part Number	Description	Ship Wt. (lbs)	Image
4.93.LED1.150	0'-150' LED dual obstruction light kit, photocell, no SOL	150	
4.93.LED3.200	160'-190' LED beacon light kit, photocell, two LED SOL	180	

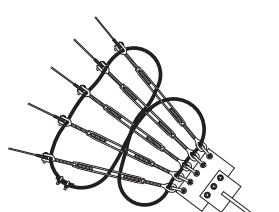

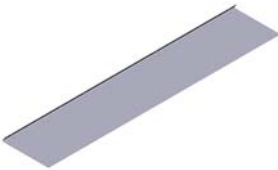

Description:	STG Splice Kit	STG Guy Bracket Assembly	STG Torsion Resistor	Guy Anchor (28 kips)
Part Number	4.618.1501.001	4.618.1502.001	4.618.2101.001	4.600.8006.001
				

Description:	5 Guy Elevation Expansion Kit	7 Guy Elevation Expansion Kit	Guy Rock Anchor (4' shaft)	Guy Anchor Grounding Kit
Part Number	4.600.0602.001	4.600.0602.002	4.600.0603.004	4.600.1201.002
				

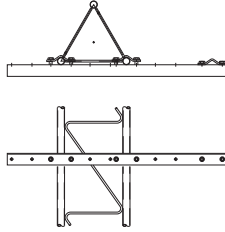

Description:	Tower Base Grounding Kit	2-Leg Grounding EIA Compliant	Ground Connector	Turnbuckle Anti-Rotation
Part Number	4.600.1201.001	4.91.0103.004	5.1303086	4.600.1506.001
				

Description:	STG Anti-Climb Kit (3-pak)	HD Universal House Bracket (6" - 36")	GAC303 Guy Anchor (7.5 kips)	GAW25 Wall and Roof Mount
Part Number	4.618.3601.001	4.600.5401.001	4.600.8001.001	4.600.5403.001
				



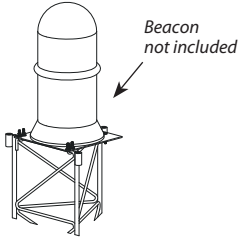
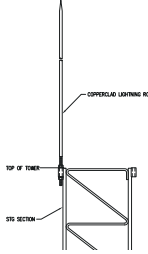
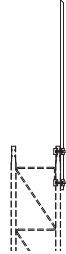
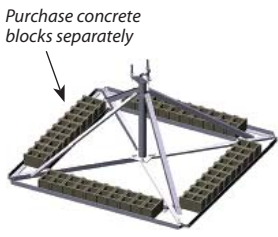



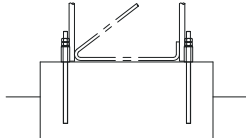
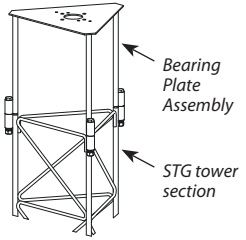

Description:	STG Work Platform	25T/STG - Site Warning Package	Side Arm Bracket - 1 Level	Side Arm Bracket - 2 Level
Part Number	4.618.1801.001	4.600.7201.001	4.600.2701.001	4.600.2702.001
				

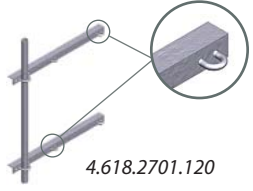
Description:	Beacon Plate Assembly	25T/STG Lightning Rod (5' long)	25T/STG Lightning Rod (8' long)	Ballast Roof Mount
Part Number	4.618.4201.001	4.90.0618.C05	4.600.1202.008	4.618.5102.001
				

Description:	TB3 Thrust Bearing (supports up to 2"OD Mast)	TB4 Thrust Bearing (supports up to 3"OD Mast)	Bolted Foundation Kit	Bearing Plate
Part Number	4.600.2703.001	4.600.2704.001	4.618.0605.001	4.618.2715.001
				

Description:	EB2525T Universal Eave Bracket
Part Number	4.600.5101.001
	

Part Number	Description	Ship Weight (lbs)	Ship L"xW"xH"	Image
4.618.2701.115	STG - 1' Side Arm Kit c/w 1.900"OD Pipe	32	36x6x6	 <p>4.618.2701.120</p>
4.618.2701.120	STG - 1' Side Arm Kit c/w 2.375"OD Pipe	41	36x6x6	
4.618.2701.125	STG - 1' Side Arm Kit c/w 2.875"OD Pipe	45	36x6x6	
4.618.2701.130	STG - 1' Side Arm Kit c/w 3.500"OD Pipe	50	36x6x6	
4.618.2701.135	STG - 1' Side Arm Kit c/w 4.000"OD Pipe	65	36x6x6	
4.618.2701.140	STG - 1' Side Arm Kit c/w 4.500"OD Pipe	71	36x6x6	
4.618.2701.215	STG - 2' Side Arm Kit c/w 1.900"OD Pipe	37	48x6x6	 <p>4.618.2701.220</p>
4.618.2701.220	STG - 2' Side Arm Kit c/w 2.375"OD Pipe	46	48x6x6	
4.618.2701.225	STG - 2' Side Arm Kit c/w 2.875"OD Pipe	50	48x6x6	
4.618.2701.230	STG - 2' Side Arm Kit c/w 3.500"OD Pipe	55	48x6x6	
4.618.2701.235	STG - 2' Side Arm Kit c/w 4.000"OD Pipe	70	48x6x6	
4.618.2701.240	STG - 2' Side Arm Kit c/w 4.500"OD Pipe	76	48x6x6	
4.618.2701.315	STG - 3' Side Arm Kit c/w 1.900"OD Pipe	42	60x6x6	 <p>4.618.2701.320</p>
4.618.2701.320	STG - 3' Side Arm Kit c/w 2.375"OD Pipe	51	60x6x6	
4.618.2701.325	STG - 3' Side Arm Kit c/w 2.875"OD Pipe	55	60x6x6	
4.618.2701.330	STG - 3' Side Arm Kit c/w 3.500"OD Pipe	61	60x6x6	
4.618.2701.335	STG - 3' Side Arm Kit c/w 4.000"OD Pipe	75	60x6x6	
4.618.2701.340	STG - 3' Side Arm Kit c/w 4.500"OD Pipe	81	60x6x6	
4.618.2701.415	STG - 4' Side Arm Kit c/w 1.900"OD Pipe	55	72x6x6	 <p>4.618.2701.420</p>
4.618.2701.420	STG - 4' Side Arm Kit c/w 2.375"OD Pipe	64	72x6x6	
4.618.2701.425	STG - 4' Side Arm Kit c/w 2.875"OD Pipe	68	72x6x6	
4.618.2701.430	STG - 4' Side Arm Kit c/w 3.500"OD Pipe	74	72x6x6	
4.618.2701.435	STG - 4' Side Arm Kit c/w 4.000"OD Pipe	88	72x6x6	
4.618.2701.440	STG - 4' Side Arm Kit c/w 4.500"OD Pipe	94	72x6x6	
4.618.2701.515	STG - 5' Side Arm Kit c/w 1.900"OD Pipe	62	84x6x6x	 <p>4.618.2701.520</p>
4.618.2701.520	STG - 5' Side Arm Kit c/w 2.375"OD Pipe	71	84x6x6x	
4.618.2701.525	STG - 5' Side Arm Kit c/w 2.875"OD Pipe	75	84x6x6x	
4.618.2701.530	STG - 5' Side Arm Kit c/w 3.500"OD Pipe	80	84x6x6x	
4.618.2701.535	STG - 5' Side Arm Kit c/w 4.000"OD Pipe	95	84x6x6x	
4.618.2701.540	STG - 5' Side Arm Kit c/w 4.500"OD Pipe	100	84x6x6x	
4.618.2701.615	STG - 6' Side Arm Kit c/w 1.900"OD Pipe	68	96x6x6	 <p>4.618.2701.620</p>
4.618.2701.620	STG - 6' Side Arm Kit c/w 2.375"OD Pipe	77	96x6x6	
4.618.2701.625	STG - 6' Side Arm Kit c/w 2.875"OD Pipe	81	96x6x6	
4.618.2701.630	STG - 6' Side Arm Kit c/w 3.500"OD Pipe	86	96x6x6	
4.618.2701.635	STG - 6' Side Arm Kit c/w 4.000"OD Pipe	101	96x6x6	
4.618.2701.640	STG - 6' Side Arm Kit c/w 4.500"OD Pipe	107	96x6x6	

Part Number	Description	Ship Weight (lbs)	Ship L'xW"xH"	Image
4.618.2702.115	STG - Face Mount c/w 1.900"OD Pipe	38	60x6x6	 <p>4.618.2702.120 Face Mount</p> <p>4.618.2702.220 Leg Mount</p>
4.618.2702.120	STG - Face Mount c/w 2.375"OD Pipe	53	60x6x6	
4.618.2702.125	STG - Face Mount c/w 2.875"OD Pipe	60	60x6x6	
4.618.2702.130	STG - Face Mount c/w 3.500"OD Pipe	69	60x6x6	
4.618.2702.135	STG - Face Mount c/w 4.000"OD Pipe	95	60x6x6	
4.618.2702.140	STG - Face Mount c/w 4.500"OD Pipe	104	60x6x6	
4.618.2702.215	STG - Leg Mount c/w 1.900"OD Pipe	37	60x6x6	
4.618.2702.220	STG - Leg Mount c/w 2.375"OD Pipe	52	60x6x6	
4.618.2702.225	STG - Leg Mount c/w 2.875"OD Pipe	59	60x6x6	
4.618.2702.230	STG - Leg Mount c/w 3.500"OD Pipe	69	60x6x6	
4.618.2702.235	STG - Leg Mount c/w 4.000"OD Pipe	94	60x6x6	
4.618.2702.240	STG - Leg Mount c/w 4.500"OD Pipe	104	60x6x6	

Cable Safety Climb Kits (OSHA approved; ANSI compliant; 3/8" aircraft)				
Part Number	Description	Ship Weight (lbs)	Ship L'xW"xH"	Image
4.99.0250.000	Cable Safety Climb Kit up to 50' STG, no slider	47	32x10x6	
4.99.0300.000	Cable Safety Climb Kit up to 100' STG, no slider	60	32x12x12	
4.99.0305.000	Cable Safety Climb Kit up to 150' STG, no slider	75	32x14x14	
4.99.0310.000	Cable Safety Climb Kit up to 200' STG, no slider	87	32x14x14	
4.99.0315.000	Cable Safety Climb Kit up to 250' STG, no slider	102	32x14x16	
4.99.0320.000	Cable Safety Climb Kit up to 300' STG, no slider	117	32x14x18	
4.99.0325.000	Cable Safety Climb Kit up to 350' STG, no slider	129	40x40x18	
4.99.0330.000	Cable Safety Climb Kit up to 400' STG, no slider	144	40x40x20	
4.99.0335.000	Cable Safety Climb Kit up to 450' STG, no slider	158	40x40x20	
4.99.0340.000	Cable Safety Climb Kit up to 500' STG, no slider	173	40x40x20	

Safety Climb Slider				
Part Number	Description	Ship Weight (lbs)	Ship L'xW"xH"	Image
4.99.0101.001	Cougar Stainless Steel Cable Slider w/Karabiner	4	6x4x3	

Safety Climb Body Harness				
Part Number	Description	Ship Weight (lbs)	Ship L'xW"xH"	Image
4.96.0100.000	Universal Safety Harness	5	16x16x8	

Antenna Cluster Mounts				
Part Number	Description	Ship Weight (lbs)	Ship L'xW"xH"	Image
4.84.3CLS.00A	3-cluster Antenna Mount, 1.66"OD tube	40	36x8x8	 <p>6-cluster Antenna Mount Illustrated</p>
4.84.6CLS.00A	6-cluster Antenna Mount, 1.66"OD tube	80	36x16x8	

# STG SERIES P.Eng. Stamped Drawings

## P.Eng. Stamped Drawings (STG Guyed, and Self-Support – Canada)

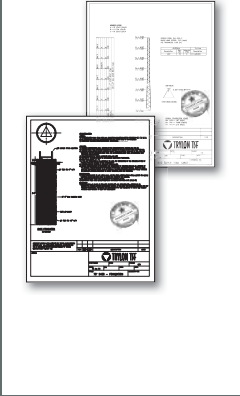
Part Number	Description	Ship Wt. (lbs)	Image
4.77.0101.920*	P.Eng. Stamped Dwg: Tower profile & standard FDN	2	
4.77.0101.960**	P.Eng. Stamped Dwg: Special soil FDN analysis & design	2	
4.77.0101.990**	P.Eng. Stamped Dwg: Tower profile & special soil FDN	2	

\* To order this P.Eng. stamped drawing, a completed Tower Loading Questionnaire must accompany your PO to Trylon's Distributor. Questions include: maximum design wind speed, radial ice accumulation, projected antenna area in sq. ft., etc.

\*\* This requires an official geotechnical soils report to be submitted along with the purchase order for this special foundation design/analysis. PO will not be accepted without geotechnical soils report for the site in question.





# Terms and Conditions

**Acceptance.** Purchase Orders shall be considered final upon acceptance by Trylon TSF (hereafter "Supplier") by issuance of a written order confirmation. The issuance by Purchaser of a Purchase Order to Supplier shall constitute acceptance by Purchaser of these Terms and Conditions which shall supersede all additional or conflicting terms and conditions on Purchaser's Purchase Order. The contract between Purchaser and Supplier shall consist of Supplier's written confirmation and these Terms and Conditions.

**Pricing.** Price quotation and terms shall remain in effect for thirty (30) days from date of issuance. Supplier reserves the right to change published pricing at any time.

**Payment Terms.** Terms of payment shall be Net thirty (30) calendar days from the date of invoice for all Product shipped by Supplier.

**Finance and Collection Charge.** Purchaser agrees to pay a finance charge, at a monthly rate of 2%, on past due invoices where allowed by applicable law. Purchaser agrees to pay Supplier all costs of collection including but not limited to reasonable legal fees, collection fees and court costs incurred by Supplier to collect properly due payments.

**Taxes.** Purchaser is responsible for all sales, use, and similar taxes, and agrees to reimburse Supplier for any such charges paid on Purchaser's behalf.

**Credit Limits.** Credit limits shall be determined and modified at the sole discretion of the Supplier. In the event that Purchaser is delinquent in payment, Supplier may suspend any shipment or delivery or refuse to perform any work until all past due amounts, including finance charges, have been paid in full.

**Shipping Terms.** Shipping terms for shipments within Canada and the United States are F.O.B. Supplier's Point of Shipment. Shipping terms for international shipments are EXW Supplier's Point of Shipment (Incoterms 2000).

**Title and Risk of Loss.** Title to and risk of loss and damage to the Products shall pass to Purchaser immediately upon delivery of the Products to a common carrier, or to an employee or other agent of Purchaser, at Supplier's facility.

**Inspection.** Purchaser or its designated representative shall inspect all Products within seven (7) calendar days after delivery of Products (hereinafter "Inspection Period") and Purchaser shall notify Supplier of any defects, shortages, overshipments, or nonconformance in any of the Products. Any Products not rejected by Purchaser within such period shall be deemed to have been accepted by Purchaser.

**Shortages/Overshipments.** In the event that Supplier delivers less than the scheduled requirements and Supplier is notified of such shortage within the Inspection Period, Supplier shall correct such shortage within a commercially reasonable period of time after receipt of written notice from Purchaser or as otherwise agreed by the parties. If Supplier delivers more than the quantity ordered, Purchaser can return any excess Product at Supplier's expense or retain such excess as mutually agreed by the parties.

**Shipping Damage.** All claims for transportation damage shall be filed and processed by the Purchaser.

**Mode of Shipment.** In the event that the Purchaser specifies in a Purchase Order the shipping carrier, type of service, and payment method (collectively hereinafter "Mode of Shipment"), freight costs shall be charged in a manner consistent with the Purchase Order. In the event that Purchaser has not specified a Mode of Shipment on a Purchase Order, at the sole discretion of Supplier, such charges may be prepaid by Supplier and added to Supplier's invoice to Purchaser.

**Purchase Orders.** Purchaser shall order Products from Supplier by issuing a Purchase Order (hereinafter "Purchase Order(s)"). All Purchase Orders must be issued in writing and signed by Purchaser's authorized representative. Any and all pre-printed terms and conditions on Purchaser's forms and documents are null and void and hereby expressly rejected, and are superseded by the terms and conditions of this Agreement.

**Cancellation.** All requests for cancellation or changes of Purchase Orders must be submitted in writing by Purchaser. In the event that Purchaser cancels or changes a Purchase Order, Purchaser agrees to pay a restocking fee of not less than 35% for standard Products and 100% for custom Products of the dollar value of the Purchase

Order line item(s) cancelled.

## Returns.

(a) Purchaser may submit a request for return of Products once Products have been delivered to a common carrier, or to an employee or other agent of Purchaser, at Supplier's facility. All requests by Purchaser to return Products must be submitted in writing to Supplier utilizing Supplier's Return Request Form. Supplier shall not consider return requests received later than ninety (90) calendar days after shipment of Products.

(b) Supplier shall evaluate the Return Request Form in a timely manner. Supplier may, at its sole discretion, issue Purchaser written authorization to ship Product back to Supplier (hereinafter "Return Material Authorization"). The issuance of a Return Material Authorization is not acceptance of the returned Product, merely authorization to return the Product for inspection. In the event that Supplier deems that the request is not made in compliance with the terms of this Agreement, Supplier shall notify Purchaser in writing that the request for return has been denied.

(c) Upon receipt of such Products, Supplier shall inspect the Products and, at its sole discretion, accept or deny the return of such Products. In the event that Supplier accepts the return of Products from Purchaser, Supplier shall issue a credit to Purchaser in the amount of the original invoice amount for the Products less a restocking charge (hereinafter "Restocking Fee"). Purchaser acknowledges that customary Restocking Fees are 35% for standard Products and 100% for custom Products. In the event that Supplier denies the return of Products from Purchaser, Supplier shall ship Products back to Purchaser at Purchaser's sole expense. All shipping costs for the return of goods are the responsibility of the Purchaser. In the event that, upon inspection, Supplier determines that the Products are subject to the terms of Supplier's warranty or that the Products were shipped by the Supplier to Purchaser due to an error by Supplier, Supplier shall waive any Restocking Fees and shall issue a credit to Purchaser for any shipping costs for the shipment of Products back to Supplier.

**Specifications.** All Products shall be manufactured to meet Supplier's current manufacturing and engineering standards. All Products shall be packaged and labelled in accordance with Supplier's standard commercial practices. Supplier reserves the right to change or modify Products at any time.

**Warranty.** Supplier warrants that, at time of shipment, the Products furnished by Supplier are free from defects in material and workmanship. Supplier's obligation under this warranty is limited to repair and replacement of any defective Product within one (1) year from the date of shipment to the first Purchaser. Supplier shall have the sole discretion as to which of these remedies it shall provide. These warranties shall not apply to any Product which has been subjected to misuse, neglect, alteration, accidental damage, damage or defects attributes after shipment, defects during storage or installation, defects attributable to improper installation or use for purposes other than the Product was intended, and any other defects out of the reasonable control of Supplier. Seller makes no warranties, guarantees, covenants or representations other than those expressly set out in this Warranty. The warranties and remedies provided herein are Purchaser's sole and exclusive remedies and are provided expressly in lieu of all other warranties, whether express, implied, or arising by statute or otherwise in law or from a course of dealing or usage of trade, including but not limited to, warranties of merchantability or fitness for a particular purpose. Purchaser agrees that Supplier's liability under this Agreement, and any Purchase Order issued pursuant to this Agreement, shall never exceed the purchase price of the line item upon which liability is based. Under no circumstances shall Supplier be liable for consequential, incidental, special, direct, or indirect damages including but not limited to labour costs, installation costs, inconvenience, cost of replacement goods, loss of revenue or profits, or other costs of any nature as a result of the use of Products manufactured by Supplier.

**Force Majeure.** Supplier shall not be liable for failure to perform any of its obligations under this Agreement to the extent such failure is caused by fire; flood; explosion; war; riot; embargo; labour disputes; compliance with any laws, regulations, orders, acts or requirements from the government, civil or military authorities; acts of God or the public enemy; or any act or event of any nature beyond the Supplier's reasonable control. In no event shall Supplier be liable to Purchaser for any special, incidental, or consequential damages as a result of delay in performance or failure to perform hereunder.



**Trylon**